



Офіційний дистриб'ютор в Україні

Тел.: (057) 714-09-09

www.irbis.ua

ELEVATOR BUCKETS

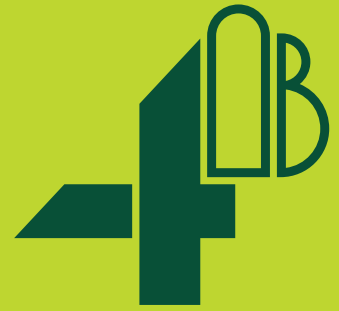

4B GROUP

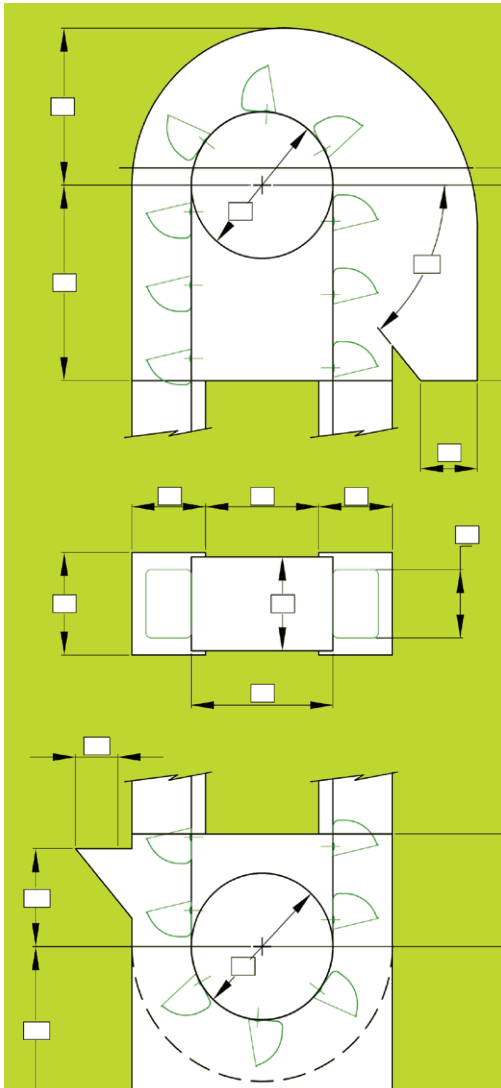

A Worldwide Manufacturer of
High Quality, Technologically Advanced
Material Handling & Electronic Components

BETTER BY DESIGN

ELEVATOR BUCKETS



SUPER STARCO™
Steel
Page 4



SUPER STARCO™
HDP/Nylon/Polyurethane
Page 6



STARCO™
Steel
Page 8



STARCO™
HDP/Nylon/Polyurethane
Page 9



STARCO JUMBO™
Steel
Page 10



GB SPIDEX™
(Bottomless) Steel
Page 12



CC-S® (Stackable)
HDP/Nylon/Polyurethane
Page 14



CC-S JUMBO
HDP/Nylon/Polyurethane
Page 16



J TYPE
Steel
Page 18



COLUMBUS
DIN 15232
Steel
Page 19



CONTINENTAL
DIN 15233
Steel
Page 20



A TYPE
Shallow Pattern
Page 21



B TYPE
Medium Pattern
Page 22



C TYPE
Medium Deep Pattern
Page 24



D TYPE
Deep Pattern
Page 25



ATLAS AA
Nylon Zytel
Page 26



ATLAS MF
Nylon Zytel
Page 27



ATLAS AD
DIN 15234
Nyrim
Page 28



ATLAS AM
Nyrim
Page 29



POLYPENCO
NBA & DIN 15234
Nylon
Page 30

HIGH EFFICIENCY BUCKETS



Page 17

ELEVATOR BOLTS

Page 31

PRODUCT SUITABILITY KEY

- Cereals
- Cement
- Heavy Industrial
- Pellets & Light Agricultural
- Light Industrial
- Sticky Materials

BUCKET ELEVATOR PERFORMANCE ANALYSIS

- 4B Engineers Can:
- > Maximize Bucket Elevator Capacity (TPH)
 - > Calculate Horsepower and Shaft Diameter Requirements
 - > Recommend Shaft / Belt Speeds
 - > Troubleshoot Elevator Issues
 - > Provide Solutions for Hazard Monitoring Compliance

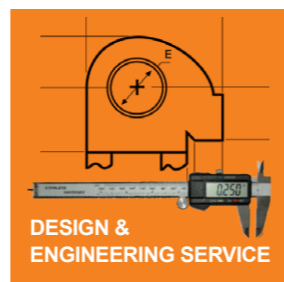

BUCKET SELECTION GUIDE

PROPERTY	MILD STEEL	STAINLESS 304	STAINLESS 316	HDP	NYLON 6	REINFORCED NYLON	POLY-URETHANE	NYRIM
Cost	1	3	4	1	2	3	4	4
Wear Resistance	3	4	4	1	2	3	3	4
Impact Resistance	2	2	2	1	2	3	2	4
Non-Stick	1	3	3	2	3	3	4	3
FDA Food Approved	✗	✓	✓	✓	✓	✓	✗	✗
Max Temp °C Continuous [#]	180+	250+	250+	70	100	150	60	110
Max Temp °C Peak [#]	200	400	400	80	120	170	70	130
Colour	Grey	Silver	Silver	White	Cream	Beige / Green	Green*	Dark Grey

Code: 1 = Low 4 = High / * Other colours on request / # Refer to our technical department

MATERIAL / APPLICATIONS

<p>Mild Steel General purpose, long life, cereals and industrial products</p>	<p>Stainless 316 Food, highly corrosive and high temperature products</p>	<p>Nylon 6 Hot, abrasive and sticky products (FDA approved)</p>	<p>Polyurethane Sharp, cutting and sticky products</p>
<p>Stainless 304 Food, corrosive and high temperature products</p>	<p>HDP Cereals and food products</p>	<p>Reinforced Nylon Hot, highly abrasive and sticky industrial products (FDA on request)</p>	<p>Nyrim Extremely abrasive, high impact industrial products</p>

OPTIONS

All our buckets can be punched to the customers own specification. The following options may be applied to any of our buckets.

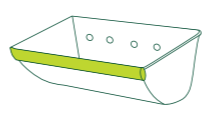

Front only

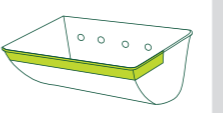

Front and part sides

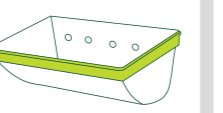

Front and full sides

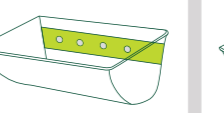

Rear reinforcing plate

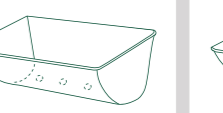

Bottom drain holes

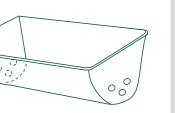

Side drain holes

HOW TO MEASURE A BUCKET



A
With elevator bucket back laid flat, measure overall length



B
With elevator bucket back laid flat, measure the horizontal projection

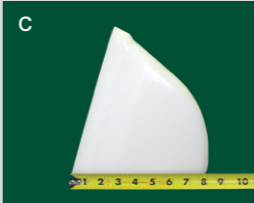

C
With elevator bucket back laid flat, measure the back depth



D
With elevator bucket back held vertical, measure front depth to front lip

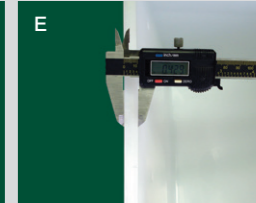

E
Using a caliper, measure the thickness of the bucket

TYPE SPS SUPER STARCO™

The Super Starco™ bucket is the result of intensive research to achieve the maximum individual bucket capacity, while still maintaining the perfect fill and discharge characteristics of the original Starco bucket over a wide speed range.

- > Versatile bucket, available in many sizes
- > Increased Volume, with the same discharge characteristics as the Starco™ bucket
- > Less buckets required per metre
- > Less bolts and punching required
- > Reduced cost for belt & bucket installation

PRESSED SEAMLESS STEEL / STAINLESS STEEL

Agricultural & Industrial

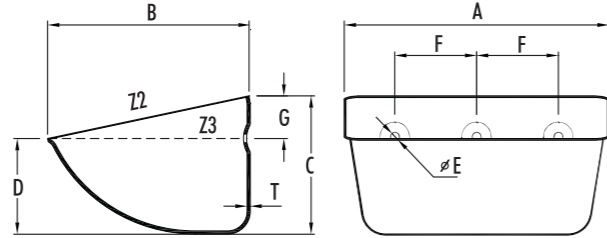

No.	A (mm)	B (mm)	C (mm)	D (mm)	T / KG						Capacity (Litres)		Recessed Holes			Max. Pcs/Mtr	
					1.0 (mm)	1.2 (mm)	1.5 (mm)	2.0 (mm)	2.5 (mm)	3.0 (mm)	Z2 (total)	Z3 (water)	No.	E (mm)	F (mm)		G (mm)
SPS80-80	85	80	58	39	0.11						0.21	0.18	2	8.0	43	16	15.00
SPS100-90	106	89	66	45	0.12		0.18			0.40	0.33	0.25	2	8.5	50	20	14.00
SPS100-100	105	97	78	46	0.18						0.42	0.29	2	8.5	50	25	12.00
SPS120-100	125	105	77	53	0.22		0.33	0.44			0.58	0.44	2	8.0	67	25	12.00
SPS140-110	146	112	91	40			0.43				0.76	0.41	2	8.5	70	25	10.50
SPS130-120	138	120	90	62		0.30	0.38				0.83	0.65	2	8.5	70	25	10.50
SPS140-120	146	120	90	62			0.40			0.80	0.87	0.65	2	8.5	70/86*	25	10.50
SPS160-140	166	147	112	78			0.55	0.73		1.10	1.58	1.20	2	8.5	100	30	8.60
SPS180-140	187	147	112	78			0.61	0.81		1.22	1.75	1.35	2	8.5	100	30	8.60
SPS200-150	205	150	112	77			0.77	1.03		1.54	2.00	1.53	2	9.0	100/102*	32	8.60
SPS230-160/A	233	160	122	85			0.86	1.15		1.72	2.72	2.05	3	9.0	70	32	8.00
SPS230-160/B	233	160	122	85			0.86	1.15		1.72	2.72	2.05	2	10.5	120	32	8.00
SPS240-160/A	247	165	130	92				1.35		2.00	3.03	2.37	3	10.5	70/77*	35	7.40
SPS240-160/B	247	165	130	92				1.35		2.00	3.03	2.37	2	10.5	140	35	7.40
SPS240-160/C	247	165	130	92				1.35		2.00	3.03	2.37	2	10.5	120	35	7.40
SPS260-165	262	165	130	92				1.38		2.10	3.28	2.55	3	10.5	77/80*	35	7.40
SPS280-165	289	167	132	93				1.55		2.32	3.78	2.80	3	10.5	80	38	7.40
SPS300-165/A	308	165	135	94				1.65	2.08	2.50	3.88	2.90	3	9.0	100/104*	36	7.20
SPS300-165/B	308	165	135	94				1.65	2.08	2.50	3.88	2.90	3	11.0	100	36	7.20
SPS330-165	340	165	135	97				1.90	2.37	2.85	4.40	3.50	3	11.0	110/120*	38	7.20
SPS350-165/A	360	165	135	94				2.12		3.20	4.50	3.65	4	9.0	90	38	7.20
SPS350-165/B	360	165	135	94				2.12		3.20	4.50	3.65	3	11.0	120	38	7.20

TYPE SPS SUPER STARCO™



No.	A (mm)	B (mm)	C (mm)	D (mm)	T / KG						Capacity (Litres)		Recessed Holes			Max. Pcs/Mtr					
					1.0 (mm)	1.2 (mm)	1.5 (mm)	2.0 (mm)	2.5 (mm)	3.0 (mm)	Z2 (total)	Z3 (water)	No.	E (mm)	F (mm)		G (mm)				
SPS230-170	235	170	132	93								1.40		3.09	2.40	2	11.0	120	35	7.00	
SPS200-180	204	182	140	98								1.28		2.84	2.17	2	11.0	110	44	7.00	
SPS260-180	270	188	140	96								1.58		4.10	3.20	3	11.0	80	45	7.00	
SPS280-180	290	185	140	97								1.70	2.55	4.40	3.30	3	11.0	80	38	7.00	
SPS300-180/A	308	182	140	95								1.80	2.70	4.50	3.50	3	9.0	100/104*	36	7.00	
SPS300-180/B	308	182	140	95								1.80	2.70	4.50	3.50	3	11.0	100	36	7.00	
SPS330-180	340	182	140	98								2.00		5.20	4.00	3	11.0	110/120*	38	7.00	
SPS350-180/A	362	182	140	98								2.10	3.15	5.40	4.20	4	11.0	90	38	7.00	
SPS350-180/B	362	182	140	98								2.10	3.15	5.40	4.20	3	11.0	120	38	7.00	
SPS370-180	385	195	140	95								2.24	2.80	6.40	4.90	4	11.0	90	38	7.00	
SPS250-215	257	215	162	113								1.86		5.30	4.10	3	11.0	85	49	5.88	
SPS280-215	294	215	163	114								2.18	2.86	6.04	4.70	3	11.0	80	50	5.88	
SPS300-215	310	220	163	112								2.32	2.90	6.70	5.20	3	11.0	100	50	5.88	
SPS330-215	340	215	163	112									2.97	3.56	7.20	5.65	3	11.0	120	50	5.88
SPS350-215	362	215	163	112									3.23	3.87	7.60	5.86	3	11.0	120	50	5.88
SPS370-215	381	215	163	112									3.32	4.00	8.10	6.30	4	11.0	90	50	5.88
SPS440-215	450	225	165	113									3.92	4.68	9.83	7.44	4	11.0	110	50	5.88
SPS450-215	464	215	163	113									4.00	4.80	9.95	7.90	5	11.0	88/90*	50	5.88
SPS470-215	480	225	165	113									4.14	4.95	10.56	8.06	4	11.0	120	50	5.88
SPS500-215	515	215	163	113									4.28	5.14	11.25	8.80	5	11.0	100	50	5.88
SPS630-215	640	220	164	113										7.40	14.29	10.92	7	11.0	90	50	5.88

Special holes/thicknesses/wearbands - available on request
Wear band size: 3.0mm on 1 or 3 sides on request / * Slotted holes to fit alternate hole centres

FOR STAINLESS STEEL, SEE PRICE LIST FOR THICKNESS OPTIONS

TYPE SPS SUPER STARCO™

The Super Starco™ bucket is the result of intensive research to achieve the maximum individual bucket capacity, while still maintaining the perfect fill and discharge characteristics of the original Starco bucket over a wide speed range.

- > Versatile bucket, available in many sizes
- > Increased Volume, with the same discharge characteristics as the Starco™ bucket
- > Less buckets required per metre
- > Less bolts and punching required
- > Reduced cost for belt & bucket installation

HDP / NYLON / POLYURETHANE

Agricultural & Industrial

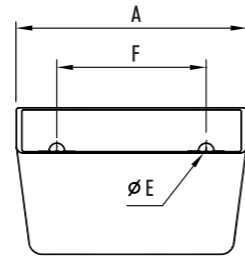
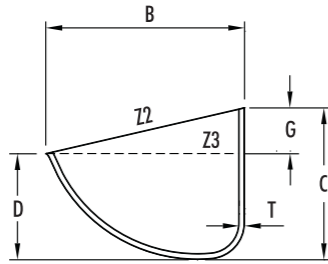

No.	A (mm)	B (mm)	C (mm)	D (mm)	T (mm)	HDP (kg)	Nylon (kg)	PU (kg)	Capacity (Litres)		No.	Holes			Available Options	Max. Pcs/Mtr
									Z2 (total)	Z3 (water)		Ø E (mm)	F (mm)	G (mm)		
SPS80-80	90	85	63	43	4	0.08	0.09	0.10	0.24	0.20	2	9.0	43	18	R	15.00
SPS100-90	110	100	67	44	5	0.11	0.13	0.15	0.39	0.32	2	9.0	50	20	R	14.00
SPS120-100	129	110	80	55	5	0.15	0.18	0.20	0.61	0.48	2	9.0	67	25	R	12.00
SPS130-120	135	120	85	57	5	0.19	0.23	0.25	0.72	0.54	2	9.0	70	25	R	11.00
SPS140-120	145	120	90	62	5	0.18	0.22	0.24	0.81	0.62	2	8.5	70	25	R	10.80
SPS130-130	146	130	90	60	5	0.21	0.25	0.28	0.88	0.68	2	9.0	70	25	R	10.80
SPS160-140	172	152	113	78	6	0.34	0.40	0.45	1.55	1.25	2	9.0	100	30	R	8.60
SPS180-140	187	150	112	77	6	0.30	0.36	0.40	1.79	1.42	2	9.0	100	30	R	8.60
SPS200-150	205	150	112	75	6	0.35	0.42	0.46	1.89	1.39	2	9.0	100	32	R	8.60
SPS300-150	305	152	115	80	7	0.65	0.77	0.86	2.92	2.28	4	9.0	51-102-51	32	N-R	8.50
SPS200-160	210	158	115	79	7	0.39	0.46	0.51	2.20	1.77	2	9.0	100	32	R	8.50
SPS230-170	240	175	138	93	7	0.61	0.73	0.81	3.09	2.42	2	11.0	120	36	R	7.00
SPS240-165	250	170	132	93	7	0.54	0.64	0.71	3.12	2.42	2	11.0	120	35	R	7.40
SPS280-165	293	170	132	95	7	0.67	0.79	0.88	3.75	3.06	3	11.0	80	36	N	7.40

TYPE SPS SUPER STARCO™



No.	A (mm)	B (mm)	C (mm)	D (mm)	T (mm)	HDP (kg)	Nylon (kg)	PU (kg)	Capacity (Litres)		No.	Holes			Available Options	Max. Pcs/Mtr
									Z2 (total)	Z3 (water)		Ø E (mm)	F (mm)	G (mm)		
SPS280-170	282	175	138	97	7	0.67	0.80	0.88	3.77	2.96	3	11.0	80	37	R	7.00
SPS280-180	290	185	140	97	7	0.84	1.00	1.11	4.21	3.34	3	11.0	80	36	N	7.00
SPS300-180	316	185	140	97	8	0.85	1.01	1.12	4.69	3.79	3	11.0	100	36	N-F	7.00
SPS330-180	347	185	140	97	8	0.90	1.07	1.19	5.30	4.10	3	11.0	110	38	N-F	7.00
SPS350-180	367	186	140	97	9	1.12	1.33	1.48	5.35	4.27	3	11.0	120	38	N-F	7.00
SPS300-215	318	220	168	117	9	1.18	1.40	1.56	6.66	5.38	3	11.0	100	50	R	5.88
SPS330-215	343	220	168	117	9	1.30	1.55	1.72	7.20	5.86	3	11.0	120	50	N-R-F	5.88
SPS350-215	368	220	168	117	9	1.38	1.64	1.82	7.75	6.20	3	11.0	120	50	R	5.88
SPS370-215	390	220	168	117	9	1.45	1.72	1.91	8.45	6.48	4	11.0	90	50	N-R-F	5.88
SPS400-215	420	220	168	117	9	1.54	1.83	2.03	9.10	7.29	4	11.0	100	50	R	5.88
SPS450-215	470	220	165	115	9	1.56	1.86	2.06	9.95	7.80	5	11.0	90	50	N-R	5.88
SPS500-215	525	220	168	117	9	1.84	2.19	2.43	11.60	9.00	5	11.0	100	50	N-R-F	5.88

N = no holes / F = flat holes / R = recessed holes / RO = recess on the outside only
Wear band size: 3.0mm on 1 or 3 sides on request / * Slotted holes to fit alternate hole centres



TYPE S STARCO™

The original STARCO™ Super Low Profile Elevator Bucket System - a bucket design for higher capacity at closer bucket spacing.

- > **Higher capacity:** up to 100% capacity increase for existing elevators
- > **More flexibility:** operates effectively over a wide speed range (from 1.25 m/s to 4.55 m/s)
- > **Unique stream discharge pattern:** reduces product damage and dust

PRESSED SEAMLESS STEEL / STAINLESS STEEL / GALVANISED

Agricultural

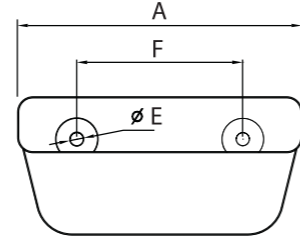
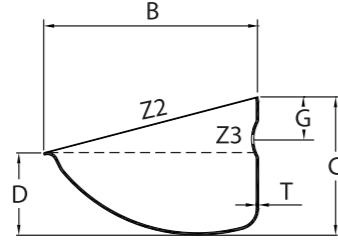

No.	A (mm)	B (mm)	C (mm)	D (mm)	T (mm)	(kg)	Capacity (Litres)		Holes			Max. Pcs/Mtr	
							Z2 (total)	Z3 (water)	No.	Ø (mm)	F (mm)		G (mm)
S100-90*	Only available for spares; now offering the SPS100-90 (see page 4)												
S130-120	138	114	80	54	1.5	0.35	0.68	0.50	2	8.5	70	22	12
S180-140	188	140	92	60	1.5	0.53	1.29	0.90	2	8.5	100	27	10.5
S230-165	239	163	108	70	2.0	1.01	2.47	1.84	2	11.0	120	34	9
S280-165	289	163	108	70	2.0	1.32	3.05	2.30	3	11.0	80	34	9
S300-180	308	182	117	70	2.0	1.43	3.66	2.46	3	9.0	100**	35	8.13
S300-215	310	217	140	89	2.0	2.05	5.60	4.10	3	11.0	100	38	7.14
S330-215/2.0	340	213	134	85	2.0	2.09	5.51	3.92	3	11.0	120	38	7.14
S330-215/2.5	340	213	134	85	2.5	2.68	5.51	3.92	3	11.0	120	38	7.14
S370-215/2.0	381	213	134	85	2.0	2.38	6.18	4.40	4	11.0	90	38	7.14
S370-215/2.5	381	213	134	85	2.5	2.98	6.18	4.40	4	11.0	90	38	7.14
S450-215	464	213	134	85	2.5	3.40	8.00	5.59	5	11.0	90***	38	7.14

Special holes/thicknesses/wearbands - available on request

* The original S100-90 is still available for spares / ** S300-180 Slotted holes for 100mm centres to 104mm centres
 *** S450-215 Slotted holes for 88mm centres to 90mm centres. Wear band 3.0mm on 1 or 3 sides on request

FOR STAINLESS STEEL, SEE PRICE LIST FOR THICKNESS OPTIONS

TYPE S STARCO™

DID YOU KNOW... The Starco bucket was originally invented by 4B Braime's French subsidiary, SETEM, in the 1980s and was the first low profile elevator bucket to use centrifugal discharge on a parabolic elevator head to achieve much higher capacities on a given elevator leg. As such, the STARCO bucket has revolutionised the elevator buckets market.



HDP / NYLON / POLYURETHANE

Agricultural

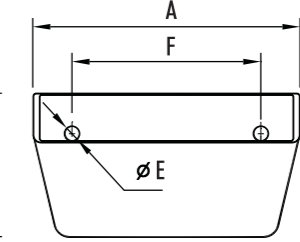
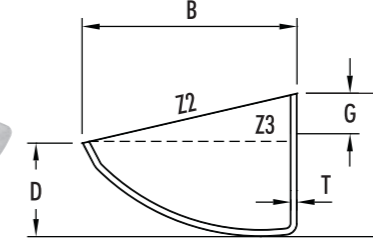

No.	A (mm)	B (mm)	C (mm)	D (mm)	T (mm)	(kg)	Capacity (Litres)		Recessed Holes			Available Options	Max. Pcs/Mtr	
							Z2 (total)	Z3 (water)	No.	Ø (mm)	F (mm)			G (mm)
S100-90 HDP-MD	109	90	62	39	4	0.06	0.30	0.23	2	8.5	50	17	R	14.28
S130-120 HDP-MD	140	121	81	54	4.7	0.13	0.65	0.50	2	8.5	70	22	R	11.11
S150-110 HDP	159	113	78	51	5.2	0.17	0.66	0.49	2	9.0	89	24	N-F	12
S180-140 HDP-MD	190	148	94	55	5.5	0.21	1.34	0.95	2	8.5	100	30	R	10.5
S180-140 HDP	190	146	94	56	6	0.22	1.25	0.98	2	9.0	100	30	N-F	10.5
S225-140 HDP	235	140	94	60	6	0.34	1.68	1.29	2	9.0	120	30	N	10.5
S230-170 HDP-MD	240	175	111	70	5.5	0.36	2.52	2.00	2	11.0	120	38	R	9
S230-170 HDP	240	173	110	70	6	0.43	2.43	1.79	2	11.0	120	35	N	9
S280-170 HDP-MD	290	173	111	75	6	0.45	3.08	2.48	3	11.0	80	38	R	9
S280-170 HDP	290	173	113	72	6	0.5	3.00	2.3	3	11.0	80	35	N-F	9
S300-180 HDP	314	181	124	81	6	0.58	3.90	2.75	3	9.0	102	38	N-F	8.13
S350-180 HDP	367	181	124	85	7	0.79	4.51	3.30	4	9.0	90	38	N-F	8.13
S330-215 HDP	342	222	141	92	8.5	0.93	5.97	4.43	3	11.0	120	38	R	7.14
S370-215 HDP	382	218	142	92	9	1.07	5.84	4.24	4	11.0	90	38	N-F-R	7.14

N = no holes / F = flat holes / R = recessed holes

TYPE SJ STARCO JUMBO™

Developed to meet the needs of industrial elevators, particularly cement. Deep drawn solid steel bucket, designed and engineered to replace large fabricated buckets. Suitable for use with both standard rubber and steel cord belting.

- > **Improved capacity:** Wingless design, improves fill and allows closer spacing
- > **Greater strength/longer life:** Solid seamless construction with rounded corners for rigidity. No welds or joints to open up
- > **Economic solution**
- > **More buckets per metre:** More capacity, smaller casing

PRESSED SEAMLESS STEEL

Industrial

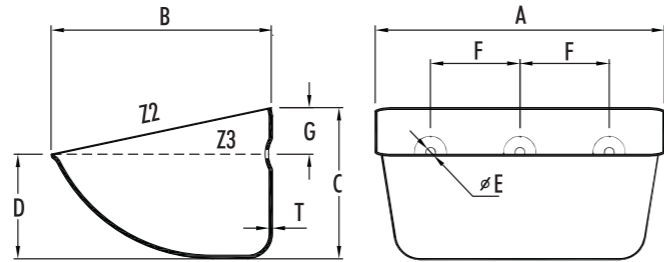

No.	A (mm)	B (mm)	C (mm)	D (mm)	T (mm)	(kg)	Capacity (Litres)		No.	Recessed Holes		G (mm)	Max. Pcs/Mtr
							Z2 (total)	Z3 (water)		E (Ø mm)	F (mm)		
SJ330-250/3	340	260	190	130	3.0	4.5	9.6	7.2	3	13	80	55	5
SJ330-250/4	340	260	190	130	4.0	6.0	9.6	7.2	3	13	80	55	5
SJ370-250/3	380	260	190	130	3.0	5.1	10.8	8.3	4	13	80	55	5
SJ370-250/4	380	260	190	130	4.0	6.8	10.8	8.3	4	13	80	55	5
SJ470-250/3	480	260	190	130	3.0	6.5	14.0	10.5	5	13	80	55	5
SJ470-250/4	480	260	190	130	4.0	8.6	14.0	10.5	5	13	80	55	5

Special holes/thicknesses/wearbands - available on request



TYPE SJ STARCO JUMBO™



SJ BUCKETS / BC CLAMP / STEEL WEB BELT

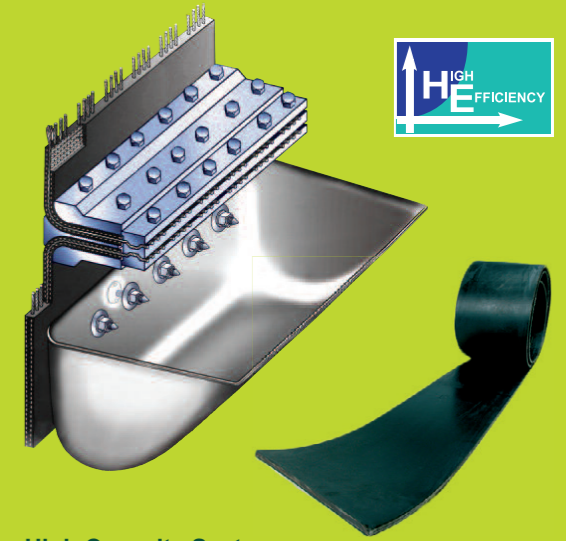

High Capacity System

A proven solution for the heavy industry. 4B can offer an integrated system of Steel Web Belting, SJ Pressed Steel Buckets and free engineering for elevator designs with compact industrial elevators.

Advantages of using the SJ System and Steel Web Belt:

- > Savings of up to 33% on component costs
- > Heavy duty but lighter weight system
- > Taller elevators are possible (up to 150m)
- > Low maintenance costs
- > Higher belt speeds are possible
- > Closer bucket spacing
- > Higher capacity and efficiency



Braime Clamp Belt Splice on 4B Steel Web Core Belt



Starco Jumbo Buckets on 4B Steel Web Core Belt Cement Application



TYPE GB GB / SPIDEX™ BOTTOMLESS

GB Spidex™ is a pressed steel bottomless bucket system that can double your existing elevator capacity and handle your troublesome materials. This unique bucket system lifts material in a continuous column, so the carrying space between conventional buckets is fully utilized by material to achieve much greater capacity.

- > Optimum possible capacity for a given elevator case
- > Cost effective increase in leg capacity
- > Self-cleaning, vented system - ideal for sticky and powdery products

PRESSED SEAMLESS STEEL / STAINLESS STEEL

Agricultural

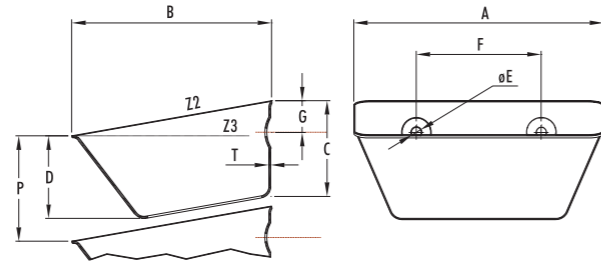

Code No.	A (mm)	B (mm)	C (mm)	T (mm)	(kg)	Capacity (Litres) Z2 (total)	No.	Recessed Holes			P** (mm)	Pcs/Mtr
								E (Ø mm)	F (mm)	G (mm)		
STANDARD RANGE												
GB130-110-B	136	114	51	1.5	0.30	0.50	2	8.5	70	22	57	17.5
GB130-110+B	136	114	51	1.5	0.36	0.50	2	8.5	70	22	57	17.5
GB180-140-B	185	139	65	1.5	0.45	1.18	2	9.0	100	32	71	14.0
GB180-140+B	185	139	65	1.5	0.55	1.18	2	9.0	100	32	71	14.0
GB230-165-B	237	163	71	2.0	0.83	2.10	2	10.0	120	32	80	12.5
GB230-165+B	237	163	71	2.0	1.12	2.10	2	10.0	120	32	80	12.5
GB300-165-B	305	166	80	2.0	1.10	2.75	3	10.5	90*	36	88	11.4
GB300-165+B	305	166	80	2.0	1.40	2.75	3	10.5	90*	36	88	11.4
GB350-200-B	355	200	100	2.5	1.95	4.75	4	11.0	90	42	111	9.0
GB350-200+B	355	200	100	2.5	2.50	4.75	4	11.0	90	42	111	9.0
GB400-220-B	410	218	115	3.0	2.30	6.91	4	11.0	100	45	125	8.0
GB400-220+B	410	218	115	3.0	2.95	6.91	4	11.0	100	45	125	8.0

* Fixing Holes GB300-165. Alternative hole punching available: Slotted for 101mm to 104mm centres

** Bucket spacing for free flowing granular products only

SPECIAL RANGE												
GB215-95-B	220	93	63	1.5	0.40	0.95	2	8.5	127	25	67	14.9
GB215-95+B	220	93	63	1.5	0.50	0.95	2	8.5	127	25	67	14.9
GB380-165-B	380	165	80	2.5	1.70	3.50	4	9.0	*	36	88	11.4
GB380-165+B	380	165	80	2.5	2.15	3.50	4	9.0	*	36	88	11.4
GB325-190-B	335	191	88	2.5	1.65	3.60	3	9.0	100	25	100	10.5
GB325-190+B	335	191	88	2.5	2.11	3.60	3	9.0	100	25	100	10.5
GB400-200-B	410	200	97	2.0	1.66	5.40	4	9.0	94	32	105	9.5
GB400-200+B	410	200	97	2.0	2.20	5.40	4	9.0	94	32	105	9.5
GB430-200-B	437	200	95	2.0	1.77	5.56	4	9.0	94	32	105	9.5
GB430-200+B	437	200	95	2.0	2.30	5.56	4	9.0	94	32	105	9.5

* Fixing Holes GB380-165, hole centres 76-127-76mm | ** Bucket spacing for free flowing granular products only

SPIDEX RANGE												
Spidex 100-90-B	106	88	45	0.9	0.10	0.23	2	8.5	50	17	50	20.0
Spidex 100-90+B	106	88	45	0.9	0.12	0.23	2	8.5	50	17	50	20.0
Spidex 130-110-B	136	114	51	1.5	0.26	0.50	2	8.5	70	22	57	17.5
Spidex 130-110+B	136	114	51	1.5	0.31	0.50	2	8.5	70	22	57	17.5
Spidex 180-140-B	185	139	65	1.5	0.41	1.08	2	9.0	100	32	71	14.0
Spidex 180-140+B	185	139	65	1.5	0.50	1.08	2	9.0	100	32	71	14.0
Spidex 280-165-B	291	165	80	2.0	0.99	2.67	3	11.0	90	36	87	11.5
Spidex 280-165+B	291	165	80	2.0	1.32	2.67	3	11.0	90	36	87	11.5
Spidex 330-190-B	341	192	99	3.0	2.07	4.50	3	12.0	100	49	105	9.5
Spidex 330-190+B	341	192	99	3.0	2.82	4.50	3	12.0	100	49	105	9.5

Note: Spidex 100-90, Spidex 130-110 and Spidex 180-140 buckets have flat holes with notched back

GB SPIDEX™ BOTTOMLESS BUCKETS



GB SPIDEX™ UNIQUE DESIGN FEATURES

With the GB system, buckets are centered at very close spacing with a series of buckets without bottoms followed by a closed bottom bucket. The material is lifted in a continuous column, so the carrying space between conventional buckets is fully utilized by material to achieve much greater capacity. The buckets "fan out" as they pass over the head and tail pulleys to facilitate pick up or discharge.

The system increases capacity of an existing elevator leg at a much lower cost than the purchase of a new bucket elevator. The GB system can also be used in new elevators to give the same capacity as larger elevators using traditional buckets, saving manufacturing costs and plant space.

GB Spidex™ buckets are particularly useful with sticky products which can clog up the bottoms of conventional buckets reducing capacity and increasing maintenance. With GB buckets, only the bucket with the bottom can become clogged, and capacity can be rated to allow for this. The remaining buckets, being bottomless, are self cleaning. Dense or extremely light materials are also handled easily as GB buckets have the ultimate vented design.

Whether your leg is handling grain, feed, meals, fertilizer, or industrial materials such as free flowing cement, 4B can design a GB Spidex™ bucket system to deliver the capacity you require.

Sample Capacity Between GB Spidex™ and CC Style Buckets:

- > GB 12 x 6: 3-7/16" Spacing, 630 ft/min Belt at Actual Working Capacity = 12,600 CFH
- > CC-HD 12 x 6: 8" Spacing, 630 ft/min Belt at Water Level +10% = 6,694 CFH

Conventional bucket systems have greater space between buckets

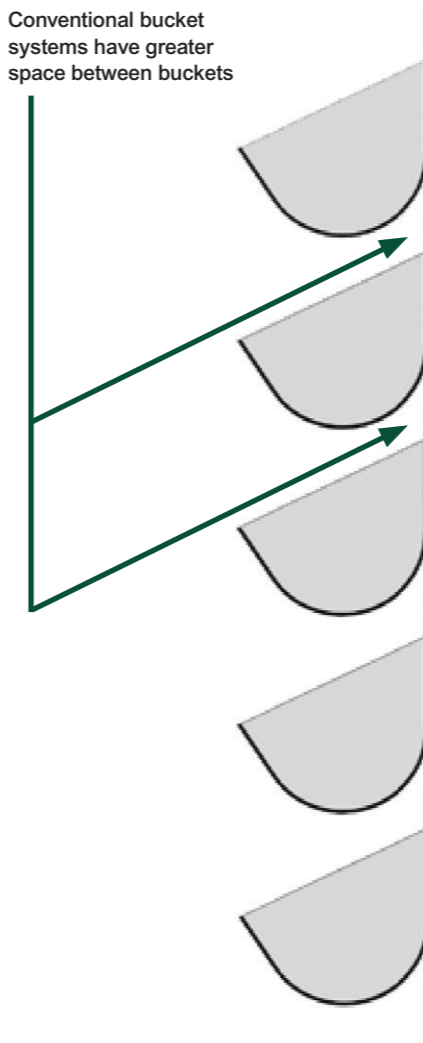

Typical Spacing For Standard Buckets



Spacing For GB Spidex™ Buckets

GB Spidex™ bottomless buckets move a continuous column of material, eliminating lost space between buckets

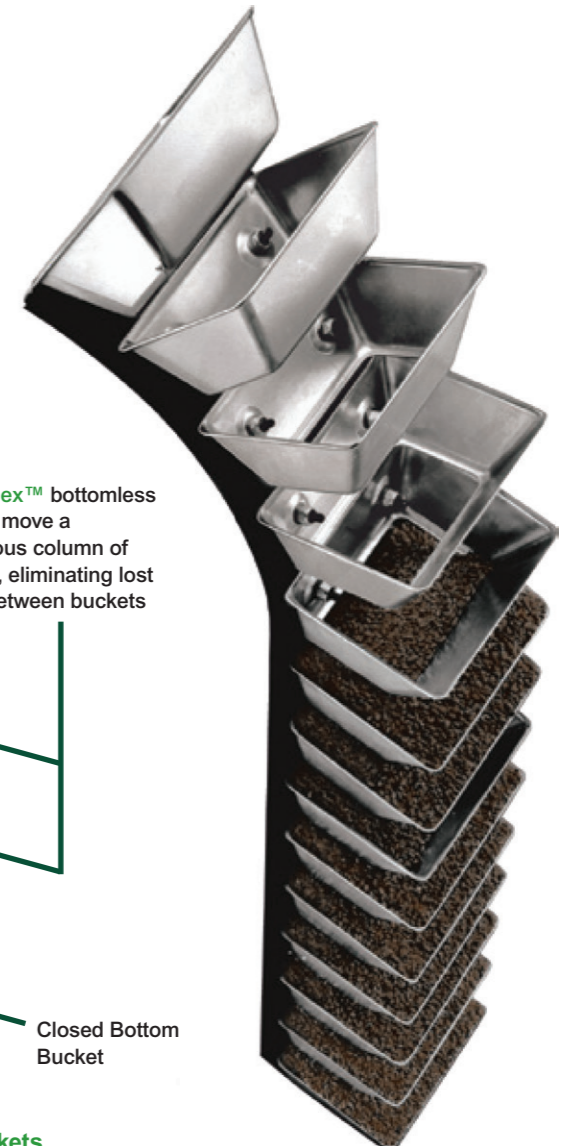

Closed Bottom Bucket

TYPE CC-S® AMERICAN GRAIN

A big volume, heavy duty bucket offering greater capacities. Moulded from premium virgin white polymer for ultimate strength and durability.

- > Stackable design saves freight and storage costs
- > Maximum impact resistance
- > Thickest front lip in the grain industry for no bowing and backlegging
- > "Iceberg edge"™ ensures clean and consistent discharge
- > "Engineered" for longer life and better performance

STACKABLE CC-S STYLE HDP / NYLON / POLYURETHANE

Agricultural

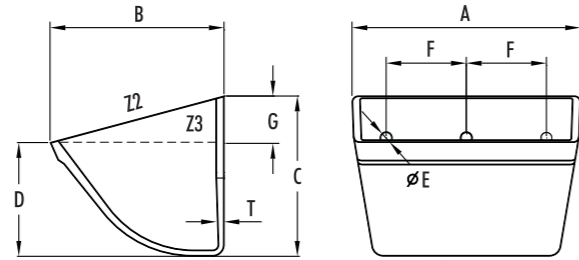

No.	A (mm)	B (mm)	C (mm)	D (mm)	T (mm)	(kg)	Capacity (Litres)			Holes			Max. Pcs/Mtr
							Z2 (total)	Z3+10%	Z3 (water)	No.	E (Ø mm)	F (mm)	
CC-S 3x2	85	64	53	35	4.5	0.05	0.13	0.14	0.10				15.75
CC-S 4x3	112	89	78	54	5.0	0.11	0.37	0.32	0.29				11.25
CC-S 5x4	135	115	103	72	5.0	0.20	0.80	0.66	0.60				8.75
CC-S 6x4	161	115	103	72	5.0	0.23	0.96	0.81	0.74				8.75
CC-S 7x4	186	115	103	72	5.0	0.26	1.13	0.96	0.87				8.75
CC-S 6x5	163	141	131	93	6.0	0.37	1.48	1.27	1.15				7.15
CC-S 7x5	189	141	131	93	6.0	0.41	1.74	1.49	1.35				7.15
CC-S 8x5	214	141	131	93	6.0	0.45	2.00	1.72	1.56				7.15
CC-S 9x5	240	141	131	93	6.0	0.50	2.22	1.88	1.71				7.15
CC-S 10x5	265	141	131	93	6.0	0.54	2.53	2.17	1.97				7.15
CC-S 11x5	290	141	131	93	6.0	0.59	2.78	2.39	2.17				7.15
CC-S 12x5	316	141	131	93	6.0	0.62	3.05	2.62	2.38				7.15
CC-S 8x6	213	171	154	105	6.0	0.56	2.76	2.31	2.10				6.00
CC-S 9x6	239	171	154	105	6.0	0.64	2.95	2.59	2.35				6.00
CC-S 10x6	264	171	154	105	6.0	0.68	3.38	3.03	2.75				6.00
CC-S 11x6	289	171	154	105	6.0	0.72	3.85	3.41	3.10				6.00
CC-S 12x6	315	171	154	105	6.0	0.78	4.30	3.63	3.30				6.00
CC-S 13x6	340	171	154	105	6.0	0.84	4.60	3.96	3.60				6.00
CC-S 14x6	358	171	154	105	6.0	0.90	5.05	4.35	3.95				6.00

To customer specification

TYPE CC-S® AMERICAN GRAIN

PRODUCT TESTING - Rigorous product testing on all of our material handling components is conducted at 4B's own in-house testing facilities. This ensures that we provide our customers with the best products in quality, durability and performance.

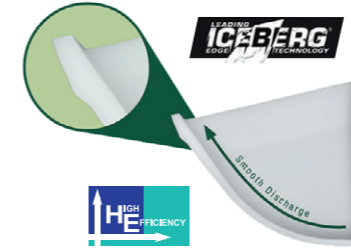

UNIQUE ICEBERG® EDGE HEAVY DUTY FRONT

Lip with maximum material thickness and a tapered leading edge for a longer wear life. The triangular rigid design prevents bowing for a consistent discharge over the life of the bucket.

No.	A (mm)	B (mm)	C (mm)	D (mm)	T (mm)	(kg)	Capacity (Litres)			Holes			Max. Pcs/Mtr
							Z2 (total)	Z3+10%	Z3 (water)	No.	E (Ø mm)	F (mm)	
CC-S 10x7	273	200	180	127	8.0	1.05	5.12	4.36	3.96				5.25
CC-S 11x7	299	200	180	127	8.0	1.10	5.60	4.80	4.40				5.25
CC-S 12x7	324	200	180	127	8.0	1.20	6.18	5.27	4.79				5.25
CC-S 13x7	350	200	180	127	8.0	1.28	6.71	5.72	5.20				5.25
CC-S 14x7	375	200	180	127	8.0	1.37	7.25	6.18	5.62				5.25
CC-S 15x7	400	200	180	127	8.0	1.45	7.76	6.63	6.03				5.25
CC-S 16x7	426	200	180	127	8.0	1.53	8.30	7.08	6.44				5.25
CC-S 10x8	275	228	210	149	10.0	1.44	6.66	5.71	5.19				4.60
CC-S 11x8	300	228	210	149	10.0	1.55	7.35	6.30	5.73				4.60
CC-S 12x8	326	228	210	149	10.0	1.66	8.07	6.92	6.29				4.60
CC-S 13x8	351	228	210	149	10.0	1.76	8.75	7.51	6.83				4.60
CC-S 14x8	377	228	210	149	10.0	1.88	9.47	8.14	7.40				4.60
CC-S 15x8	402	228	210	149	10.0	1.97	10.16	8.73	7.94				4.60
CC-S 16x8	427	228	210	149	10.0	2.05	10.85	9.33	8.48				4.60
CC-S 18x8	479	228	210	149	10.0	2.30	12.28	10.57	9.61				4.60
CC-S 20x8	529	228	210	149	10.0	2.50	13.65	11.77	10.70				4.60

To customer specification

STACKABLE DESIGN FOR REDUCED SHIPPING & STORAGE COSTS



TYPE JCC-S JUMBO CC-S



The **JUMBO CC-S**® is an ultra heavy duty version of the CC-S heavy duty elevator bucket, and part of 4B's High Efficiency bucket range. It is intended for the most severe applications, including port terminals, ethanol plants and highly abrasive materials. It offers the greatest capacity and thickest front lip, corners and walls available. The unique Iceberg Edge front face delivers impact resistance and long life. It shares the proven geometry and design features of the CC-S, including the benefit of stackability, which saves on freight costs and storage space.

ULTRA HEAVY-DUTY CC-S STYLE HDP / NYLON / POLYURETHANE

Agricultural & Industrial

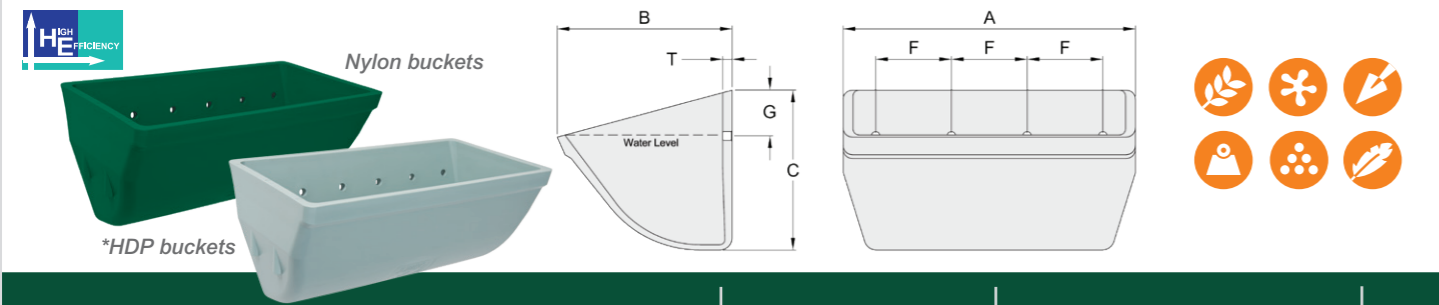

No.	A (mm)	B (mm)	C (mm)	D (mm)	T (mm)	(kg)	Capacity (Litres)			No.	Holes			Max. Pcs/Mtr
							Z2 (total)	Z3+10%	Z3 (water)		E (Ø mm)	F (mm)	G (mm)	
JCC-S 14x8	377	234	211	148	13.0	2.20	9.47	8.14	7.40	5	11	75	60	4.6
JCC-S 16x8	432	234	211	148	13.0	2.42	10.92	9.41	8.55	6	11	70	60	4.6
JCC-S 18x8	483	234	211	148	13.0	2.70	12.42	10.7	9.73	5	11	95	60	4.6
JCC-S 20x8	534	234	211	148	13.0	2.86	13.83	11.94	10.85	6	11	90	60	4.6
JCC-S 22x8	585	234	211	148	13.5	3.26	15.16	11.94	11.89	6	11	100	60	4.6
JCC-S 24x8	634	234	211	148	13.5	3.52	16.51	14.26	12.96	7	11	90	60	4.6

* JCC-S buckets are a gray/blue colour in HDP and dark green in Nylon.

UNIQUE ICEBERG® EDGE

Front lip offers superior material thickness for the ultimate in wear resistance and long life. Its triangular base creates a stiffening ridge across the front face of the bucket, preventing bowing and ensuring a consistent discharge over the life of the bucket. The tapered leading edge generates a low digging factor. This means less material resistance, less material degradation and fewer forces on the bucket system.



- > SUPER STRONG
- > CARRIES MORE
- > LASTS LONGER

HIGH EFFICIENCY ELEVATOR BUCKETS



At 4B, our basis has always been engineering and our expertise in providing comprehensive solutions. In keeping with these core values, we designed our family of High Efficiency elevator buckets to deliver the maximum possible elevator leg throughput for the lowest cost per ton. Every bucket in every line of the High Efficiency family has five distinct features, each of which conveys efficiency. Only 4B High Efficiency elevator buckets have all five features.

MODERN HIGH EFFICIENCY DESIGN

SMOOTH FRONT FACE

A smooth interior face and side walls, with no "breaks", deliver an efficient and unencumbered discharge over higher speeds.



WING-LESS SIDEWALLS

Wing-less side walls maximize the most efficient use and cost of materials.

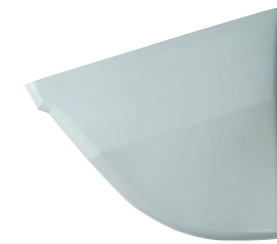

CLOSER SPACING

The ability to be mounted extremely close together provides the most efficient use of vertical space on the belt.



TAPERED BOTTOMS

Tapered bottoms allow the buckets to fill and discharge with maximum efficiency over higher speeds.



NESTING / STACKING

Nesting inside one another efficiently reduces the amount of space and costs associated with shipping and storage.



TRADITIONAL DESIGN

Other designs have angled "breaks" which provide no benefit to discharge efficiency. These "breaks" merely copy a feature from the first sheet metal buckets introduced in the 1920's.

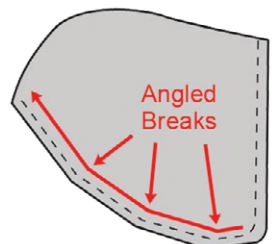

Other buckets have a wing or "ear" on both sides which adds cost and weight, while offering no functional benefit.

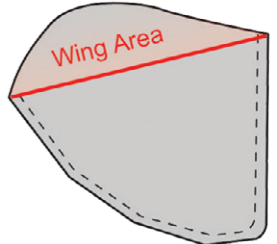

Other buckets are too deep to be mounted closely together or must be modified from their standard design, adding to the cost.

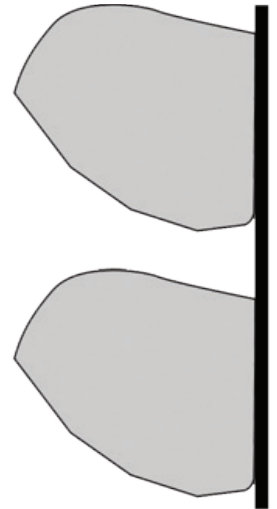

The vertical sides, wings and perpendicular bottoms of other buckets impede the flow of materials into and out of the bucket.

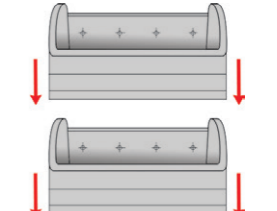

Nesting is not possible with other bucket designs. More packing materials and space are required for these buckets.



TYPE J AMERICAN GRAIN

A big volume, CC-style steel bucket designed for use with free flowing materials. For use in medium and high speed elevators.

- > **High capacity:** Wingless design, improves fill and allows closer spacing on belt
- > **Greater strength/longer life:** Solid seamless construction with rounded corners for rigidity. No welds or joints to open up
- > **Fully interchangeable** with CC style buckets

PRESSED SEAMLESS STEEL / STAINLESS STEEL

Agricultural

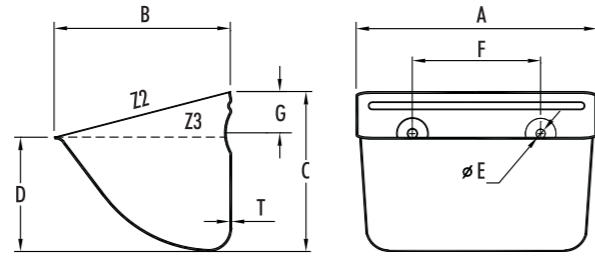

No.	A (mm)	B (mm)	C (mm)	D (mm)	T (mm)	(kg)	Capacity (Litres)			Recessed Holes			Max. Pcs/Mtr	
							Z2 (total)	Z3+10%	Z3 (water)	No.	E (Ø mm)	F (mm)		G (mm)
J64	161	110	100	71	1.2	0.45	1.00	0.85	0.77	To customer specification				8.75
J75	190	138	121	76	1.5	0.69	1.74	1.36	1.24		7.15			
J85	213	141	121	83	1.5	0.82	2.10	1.78	1.62		7.15			
J95	235	137	120	76	1.5	1.02	2.57	1.8	1.63		7.15			
J96	235	160	150	92	2.0	1.46	3.26	2.48	2.25		6.00			
J106	262	160	150	92	2.0	1.66	3.87	2.87	2.61		6.00			
J116	287	163	154	95	2.0	1.85	4.08	3.24	2.95		6.00			
J126	313	160	150	92	2.0	2.03	4.34	3.44	3.13		6.00			
J117	290	191	171	107	2.0	2.10	5.74	4.40	4.00		5.25			
J127	316	191	171	107	2.0	2.24	6.06	4.77	4.34		5.25			
J147	367	191	171	107	2.0	2.49	7.34	5.46	4.96		5.25			
J167	417	191	171	107	2.0	2.83	8.39	6.24	5.67		5.25			
J148	362	210	203	121	2.0	2.89	9.00	7.00	6.36		4.60			
J168	413	210	203	121	2.0	3.40	10.32	8.00	7.26		4.60			



TYPE G COLUMBUS DIN 15232

Agricultural Pressed Steel Bucket.

- > Supplied complete with standard recessed holes
- > **Ideal for free flowing materials on medium speed elevators**

PRESSED STEEL / STAINLESS STEEL

Agricultural

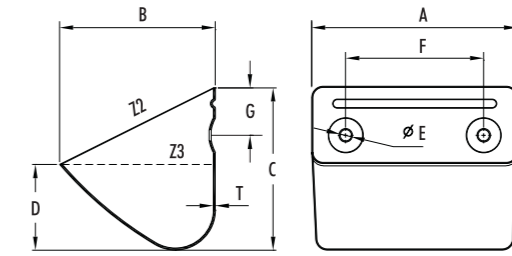

No.	A* (mm)	B* (mm)	C* (mm)	D* (mm)	T (mm)	(kg)	Capacity (Litres)		Recessed Holes			
							Z2 (total)	Z3 (water)	No.	E (Ø mm)	F (mm)	G (mm)
STANDARD RANGE												
G80	80	75	80	40	1.0	0.13	0.25	0.16	2	8.0	43	19
G90	90	80	85	45	1.0	0.16	0.33	0.22	2	8.0	46	19
G100	100	90	91	45	1.0	0.18	0.42	0.27	2	8.0	58	23
G110	110	95	95	50	1.0	0.21	0.51	0.33	2	8.0	64	26
G120	120	100	105	55	1.0	0.25	0.70	0.41	2	8.0	67	29
G130	130	105	110	58	1.0	0.30	0.81	0.49	2	8.0	78	32
G140	140	115	117	63	1.0	0.33	1.05	0.62	2	8.0	86	35
G150	150	125	123	66	1.0	0.36	1.21	0.75	2	8.0	87	33
G160/1.5	160	125	126	70	1.5	0.57	1.31	0.89	2	9.5	101	36
G160/2.0	160	125	126	70	2.0	0.76	1.31	0.89	2	9.5	101	35
G180/1.5	180	130	130	76	1.5	0.67	1.62	1.04	2	9.5	110	39
G180/2.0	180	130	130	76	2.0	0.89	1.62	1.04	2	9.5	110	39
G200/1.5	200	140	145	88	1.5	0.84	2.25	1.50	2	9.5	131	45
G200/2.0	200	140	145	88	2.0	1.12	2.25	1.50	2	9.5	131	45
G225/1.5	225	145	153	90	1.5	1.01	2.81	1.80	3	9.5	70	40
G225/2.0	225	145	153	90	2.0	1.30	2.81	1.80	3	9.5	70	40
G250/1.5	250	150	158	92	1.5	1.13	3.15	2.07	3	9.5	77	45
G250/2.0	250	150	158	92	2.0	1.46	3.15	2.07	3	9.5	77	45
G300/1.5	300	155	160	95	1.5	1.35	4.20	2.75	3	9.5	104	48
G300/2.0	300	155	160	95	2.0	1.74	4.20	2.75	3	9.5	104	48
G350/1.5	350	180	190	100	1.5	1.86	6.37	4.03	4	11.0	90	54
G350/2.0	350	180	190	100	2.0	2.35	6.37	4.03	4	11.0	90	54
G400/2.0	400	200	212	112	2.0	3.00	8.17	5.32	4	11.0	100	80
G400/2.5	400	200	212	112	2.5	3.75	8.17	5.32	4	11.0	100	80
G500	500	224	236	125	3.0	6.00	14.50	9.50	5	14.0	100	90
SPECIAL RANGE												
GS350-230	359	232	236	108	2.5	3.85	9.97	5.22	4	12.0	80	90
GS350-240	359	244	236	125	2.5	3.91	10.25	6.80	4	12.0	80	90
GS500/1 HDP	500	226	247	117	9.0	2.35	13.35	6.90				
GS500HDP	500	240	253	117	8.5	2.44	14.58	7.98				

* Note: Dimensions for G Type measured internally in accordance with DIN Norm



TYPE H CONTINENTAL DIN 15233

- Industrial Pressed Steel Bucket.
- > Supplied complete with standard recessed holes
 - > Low front and open profile
 - > Ideal for handling difficult, sticky industrial materials

PRESSED SEAMLESS STEEL Industrial



No.	A* (mm)	B* (mm)	C* (mm)	D* (mm)	T (mm)	Capacity (Litres)			Recessed Holes			
						(kg)	Z2 (total)	Z3 (water)	No.	E (Ø mm)	F (mm)	G (mm)
H160	162	140	160	63	2.0	0.98	1.80	0.80	2	9.5	80	56
H200	200	160	180	71	2.0	1.30	2.84	1.29	2	11.5	125	63
H250	253	182	200	80	2.0	1.71	4.45	2.06	3	11.5	80	71
H315/2.0	315	202	224	90	2.0	2.40	6.50	3.20	3	11.5	112	80
H315/3.0	315	202	224	90	3.0	3.60	6.50	3.20	3	11.5	112	80
H400/2.0**	407	240	275	113	2.0	4.00	13.40	6.50	4	11.5	100	90
H400/3.0**	407	240	275	113	3.0	6.00	13.40	6.50	4	11.5	100	90

* Note: Dimensions for H Types measured internally in accordance with DIN Norm / ** Not to DIN Norm



TYPE A SHALLOW PATTERN

- Pressed Seamless Steel Bucket.
- > For sticky materials at slow speeds
 - > For free flowing materials at higher speeds and closer spacing

PRESSED SEAMLESS STEEL Agricultural



No.	A (mm)	B (mm)	C (mm)	D (mm)	T (mm)	Capacity (Litres)			Bolt Holes			
						(kg)	Z2 (total)	Z3 (water)	No.	E (Ø mm)	F (mm)	G (mm)
A29	152	108	124	38	1.2	0.39	0.96	0.34	To customer specification			
A32	178	108	124	38	1.5	0.57	1.20	0.44				
A59	229	121	143	48	3.0	1.70	1.88	0.75				
A69	254	149	187	67	3.0	2.31	3.65	1.47				
A72	305	168	229	86	3.0	3.27	3.24	2.50				



LOOKING FOR A REPLACEMENT ELEVATOR BUCKET?

Send us the bucket measurements and ideally a picture – and we'll find the matching bucket for you.

TYPE B MEDIUM PATTERN

Pressed Seamless Steel / Stainless Steel / HDP.

- > Good versatile medium capacity bucket
- > For sticky materials at slow speeds
- > For free flowing materials at higher speeds and closer spacing

PRESSED STEEL / STAINLESS STEEL / HDP

Agricultural & Industrial

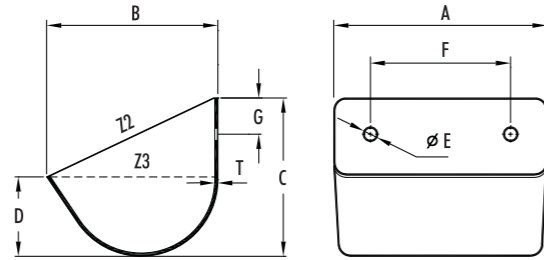

No.	A (mm)	B (mm)	C (mm)	D (mm)	T (mm)	Capacity (Litres)			Bolt Holes							
						(kg)	Z2 (total)	Z3 (water)	No.	E (Ø mm)	F (mm)	G (mm)				
B10	64	51	57	32	1.2	0.08	0.10	0.06	To customer specification							
B17	76	70	67	35	0.9	0.10	0.18	0.10								
B21	95	70	67	35	1.2	0.14	0.22	0.13								
B38	102	86	83	35	1.2	0.18	0.38	0.20								
B44	127	86	83	35	1.2	0.23	0.46	0.23								
B63	127	89	89	38	1.2	0.27	0.55	0.30								
B66	140	89	89	38	1.2	0.29	0.62	0.32								
B70	152	89	89	38	1.2	0.32	0.64	0.34								
B114 P+R	152	95	98	38	1.5	0.41	0.75	0.42					2	8.7	83	25
B114	152	95	98	38	1.5	0.41	0.75	0.42					To customer specification			
B117	152	95	98	38	3.0	0.79	0.75	0.42	To customer specification							
B134 HDP	220	106	104	50	4.0	0.18	1.15	0.62	2	8.7	127	36				
B134 P+R	216	95	98	38	1.5	0.57	1.15	0.57	2	8.7	127	25				
B135	229	95	98	38	1.5	0.59	1.25	0.60	To customer specification							
B135 P+R	229	95	98	38	1.5	0.59	1.25	0.60	2	8.7	127	25				
B147	152	117	108	54	1.5	0.52	1.10	0.59	To customer specification							
B149	152	117	108	54	3.0	0.98	1.10	0.59								
B151	178	117	108	54	1.5	0.54	1.15	0.65								
B153	178	117	108	54	3.0	1.02	1.15	0.65								
B155	203	117	108	54	1.5	0.64	1.40	0.83								
B157	203	117	108	54	3.0	1.20	1.40	0.83								
B166	127	121	114	54	1.2	0.36	0.95	0.50								
B167	127	121	114	54	1.5	0.43	0.95	0.50								
B167 P+R	127	121	114	54	1.5	0.43	0.95	0.50					2	8.7	70	32
B175	152	121	114	54	1.5	0.54	1.10	0.64								
B188	191	121	114	54	2.0	0.77	1.40	0.83								
B198	229	121	114	54	1.2	0.57	1.75	1.00								
B200	229	121	114	54	2.0	0.88	1.75	1.00								
B201	229	121	114	54	3.0	1.29	1.75	1.00								
B205	254	120	114	55	1.5	0.82	1.9	1.1								
B211	178	130	114	54	1.5	0.59	1.45	0.80								

TYPE B MEDIUM PATTERN



No.	A (mm)	B (mm)	C (mm)	D (mm)	T (mm)	Capacity (Litres)			Bolt Holes			
						(kg)	Z2 (total)	Z3 (water)	No.	E (Ø mm)	F (mm)	G (mm)
B219	203	130	114	54	1.5	0.64	1.65	0.92	To customer specification			
B221	203	130	114	54	3.0	1.29	1.65	0.92				
B234	241	130	114	54	3.0	1.56	2.00	1.15				
B237	254	130	114	54	2.0	1.09	2.10	1.25				
B238	254	130	114	54	3.0	1.54	2.10	1.25				
B242	279	130	114	54	3.0	1.72	2.35	1.35				
B258	203	133	127	54	1.5	0.79	1.85	0.90				
B263	229	133	127	54	1.5	0.86	2.00	1.00				
B266	229	133	127	54	3.0	1.56	2.00	1.00				
B269	254	133	127	54	2.0	1.13	2.25	1.15				
B278	305	133	127	54	1.5	1.00	2.80	1.35				
B281	305	133	127	54	3.0	2.00	2.80	1.35				
B283*	333	140	140	60	1.5	1.18	3.75	2.00				
B297	203	152	149	57	3.0	1.63	2.25	1.00				
B301	254	152	149	57	3.0	2.00	2.75	1.40				
B303	305	152	149	57	1.5	1.18	3.50	1.75				
B304 HDP	298	145	149	48	6.5	0.47	3.00	1.18				
B304 P+R	305	152	149	57	2.0	1.56	3.50	1.75	4	8.7	51-102-51	44
B305	305	152	149	57	3.0	2.31	3.5	1.75	To customer specification			
B307	381	152	152	67	2.0	1.93	4.85	2.50				
B307 P+R	381	152	152	67	2.0	1.93	4.85	2.50	4	8.7	76-127-76	-
B364	254	152	178	83	2.0	1.54	3.60	2.00				
B365	254	152	178	83	3.0	2.27	3.60	2.00				
B323	305	178	181	79	3.0	2.83	5.50	2.75				
B328	356	178	181	79	3.0	3.52	6.52	3.25				
B335	305	178	206	79	3.0	3.02	5.75	2.50				
B339	381	210	184	86	3.0	4.08	8.00	4.25				
B340	457	235	210	102	3.0	5.08	13.00	7.00				
B341	457	235	210	102	4.7	6.26	13.00	7.00				

HDP - High density polyethylene with standard recessed holes. P + R - With standard recessed holes
 * Non stock item - Only made to order

TYPE C MEDIUM DEEP PATTERN

- Pressed Seamless Steel. > For free flowing materials
> For other materials at slower speeds



PRESSED SEAMLESS STEEL

Agricultural & Industrial

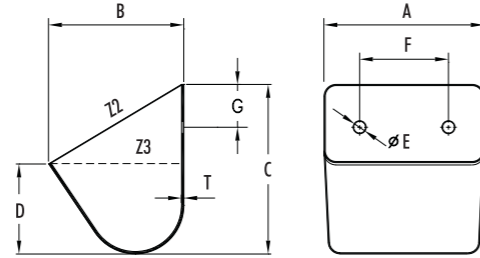
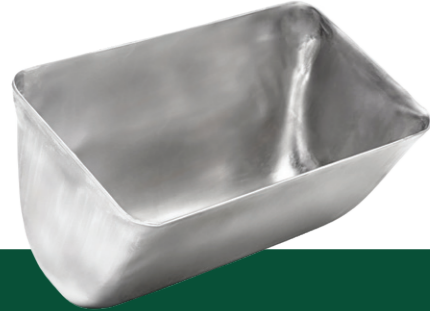

No.	A (mm)	B (mm)	C (mm)	D (mm)	T (mm)	Capacity (Litres)			Bolt Holes							
						(kg)	Z2 (total)	Z3 (water)	No.	E (Ø mm)	F (mm)	G (mm)				
C240	89	79	92	51	1.2	0.18	0.35	0.21	To customer specification							
C14	102	79	92	51	2.0	0.36	0.40	0.24								
C16	127	79	92	51	1.2	0.25	0.49	0.30								
C19	127	79	92	51	3.0	0.50	0.49	0.30								
C22	152	79	92	51	1.5	0.36	0.59	0.36								
C22P	152	79	92	51	1.5	0.36	0.59	0.36					2	7.0	54	38
C27	102	89	108	57	2.0	0.39	0.52	0.32								
C30	127	89	108	57	1.2	0.29	0.66	0.40								
C33	127	89	108	57	3.0	0.68	0.66	0.40								
C37	152	89	108	57	2.0	0.53	0.78	0.50								
C38	152	89	108	57	3.0	0.79	0.78	0.50								
C42	178	89	108	57	2.0	0.68	0.96	0.60								
C193	140	95	111	57	1.2	0.32	0.79	0.46								
C98	127	102	127	67	1.2	0.34	0.89	0.55								
C104	152	102	127	67	1.5	1.02	1.10	0.66								
C116	203	102	127	67	3.0	1.25	1.50	0.92								
C119	229	102	127	67	1.5	0.79	1.80	1.10								
C123	127	114	143	76	1.2	0.43	1.15	0.70								
C129	152	114	143	76	1.5	0.61	1.35	0.85								
C131	152	114	143	76	3.0	1.16	1.35	0.85								
C135	178	114	143	76	1.5	0.68	1.60	1.00								
C138	178	114	143	76	3.0	1.34	1.60	1.00								
C141	203	114	143	76	1.5	0.73	1.81	1.06								
C144	203	114	143	76	3.0	1.45	1.81	1.06								
C154	254	114	143	76	1.5	0.93	2.30	1.40								
C156	254	114	143	76	3.0	1.81	2.30	1.40								
C159	152	140	159	95	2.0	1.07	1.80	1.20								
C162	178	140	159	95	1.5	0.84	2.15	1.40								
C166	203	140	159	95	1.5	0.95	2.45	1.65								
C168	203	140	159	95	3.0	1.72	2.45	1.65								
C170	229	140	159	95	1.5	1.07	2.85	1.85								
C171	229	140	159	95	2.0	1.36	2.85	1.85								
C172	229	140	159	95	3.0	1.97	2.85	1.85								
C175	254	140	159	95	2.0	1.43	3.10	2.00								
C176	254	140	159	95	3.0	2.04	3.10	2.00								
C179	279	140	159	95	1.5	1.20	3.55	2.35								
C181	279	140	159	95	3.0	1.86	3.55	2.35								
C184	305	140	159	95	2.0	1.77	4.05	2.70								
C185	305	140	159	95	3.0	2.54	4.05	2.70								
C231	356	181	181	117	3.0	3.61	6.55	4.70								

To customer specification

TYPE D DEEP PATTERN

- Pressed Seamless Steel Bucket. > For free flowing materials
> For materials elevated at slower speeds with gravity discharge
> Mainly for heavy duty applications



PRESSED SEAMLESS STEEL

Industrial

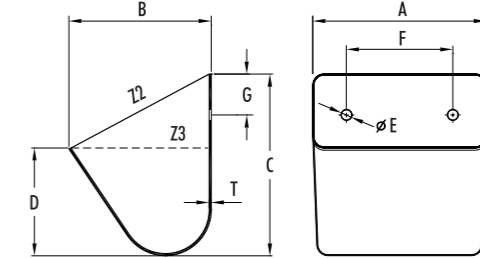

No.	A (mm)	B (mm)	C (mm)	D (mm)	T (mm)	Capacity (Litres)			Bolt Holes			
						(kg)	Z2 (total)	Z3 (water)	No.	E (Ø mm)	F (mm)	G (mm)
D21	203	127	146	86	3.0	1.50	2.10	1.35	To customer specification			
D55	229	152	200	111	3.0	2.59	3.95	2.40				
D58	254	152	200	111	2.0	1.84	4.40	2.65				
D61	254	152	200	111	3.0	2.59	4.40	2.65				
D64	279	152	200	111	3.0	2.77	4.85	3.00				
D66	305	152	200	111	1.5	1.54	5.20	3.20				
D69	305	152	200	111	3.0	3.02	5.20	3.20				
D70	305	152	200	111	4.7	4.74	5.20	3.20				
D96	356	184	229	108	3.0	3.99	7.80	4.35				
D120	457	191	254	133	4.7	9.00	12.20	7.65				
D160	406	197	244	140	3.0	5.17	10.75	7.20				
D180	406	197	244	140	4.7	7.89	10.75	7.20				
D123	508	203	273	149	4.7	10.54	15.25	9.25				
D131	619	210	298	127	3.0	7.80	20.00	9.50				
D181	381	222	254	140	4.7	7.94	12.15	7.35				



ATLAS ATLAS AA

Heavy Duty Toughened Nylon Buckets. "AA" Style and "Continuous" Style Heavy Duty Injection Moulded Nylon.

- > **Solid construction:** manufactured from DuPont 'Zytel' ST super-tough nylon, urethane or high density polyethylene
- > **Solid through and through:** no occlusions within the structure (injection moulded to achieve uniformly high physical properties)
- > **Corrosion and abrasion resistant**
- > For use in applications between **-50°C and 150°C**
- > For applications in: sand, aggregate, cement, coal, sugar, fertilizer, salt, glass
- > Also available in food grade HDP or Nylon to meet USDA/FDA standards

NYLON 'ZYTEL' Industrial/Sticky





No.	Nominal Size (mm)	A (mm)	B (mm)	C (mm)	D (mm)	T (mm)	X°	Capacity (Litres)		
								(kg)	Z2 (total)	Z3 (water)
AA43TN	110 x 80	103	78	78	51	5.5	37	0.09	0.27	0.21
AA54TN	130 x 100	134	105	105	74	7	37	0.23	0.74	0.57
AA64TN	150 x 100	160	105	105	74	7	37	0.27	0.89	0.68
AA74TN	180 x 100	184	105	105	74	7	37	0.30	1.07	0.84
AA75TN	180 x 130	180	130	134	93	8	37	0.44	1.55	1.26
AA85TN	200 x 130	206	130	134	93	8	37	0.50	1.83	1.47
AA95TN	230 x 130	232	130	134	93	8	37	0.54	2.00	1.66
AA96TN	230 x 150	238	156	156	108	8.5	37	0.67	2.80	2.17
AA106TN	250 x 150	264	156	156	108	8.5	37	0.73	3.14	2.43
AA116TN	280 x 150	290	156	156	108	8.5	37	0.77	3.43	2.68
AA126TN	300 x 150	320	165	160	108	8.5	38	0.95	4.10	3.08
AA127TN/S	300 x 180	305	178	178	98	7	37	0.92	4.10	2.95
AA127TN	300 x 180	314	180	180	125	9	37	1.13	5.25	4.00
AA147TN	350 x 180	365	180	180	125	9	37	1.25	6.30	4.89
AA148TN	350 x 200	365	206	206	142	11	37	1.94	7.60	5.76
AA168TN	400 x 200	416	206	206	142	12.5	37	2.10	8.85	6.66
AA188TN	450 x 200	460	206	206	142	12.5	37	2.38	10.15	7.66
AA1810TN	450 x 250	460	258	258	168	12.5	37	3.60	14.80	11.00

Mounting holes and venting to customer specification





ATLAS ATLAS MF



Industrial Duty Toughened Nylon Buckets. "Continuous" Style Heavy Duty Injection Moulded Nylon.

- > **Solid construction:** manufactured from DuPont 'Zytel' ST super-tough nylon urethane or high density polyethylene
- > **Solid through and through:** no occlusions within the structure
- > **Medium front** for use in continuous discharge elevators
- > **Corrosion and abrasion resistant**
- > For use in applications up to **150°C**

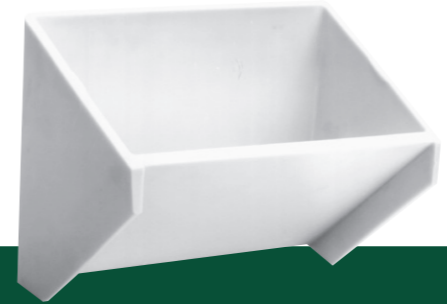
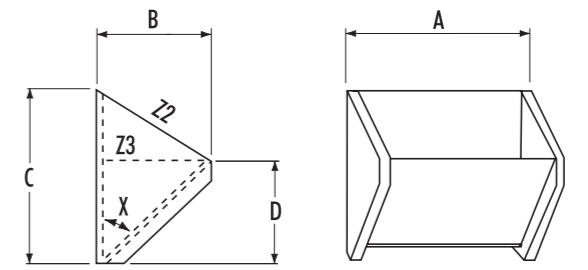
NYLON 'ZYTEL' Industrial

No.	Nominal Size (mm)	A (mm)	B (mm)	C (mm)	D (mm)	T (mm)	X°	Capacity (Litres)		
								(kg)	Z2 (total)	Z3 (water)
MF85	200 x 130	210	140	190	118	8	50	0.88	2.04	1.22
MF105	250 x 130	260	140	190	118	8	50	1.07	2.50	1.55
MF128	300 x 200	310	216	300	175	8	50	2.17	8.01	4.77
MF148	350 x 200	362	216	300	175	8	50	2.36	9.01	5.51
MF168	400 x 200	413	216	300	175	8	50	2.61	10.55	6.42
MF188	450 x 200	463	216	300	175	8	50	2.85	12.10	7.24

Mounting holes and venting to customer specification



ATLAS ATLAS AD DIN 15234

DIN 15234 'Nyrim' Super Tough Industrial Duty Elevator Bucket High capacity.

- > **Solid construction:** manufactured from 'Nyrim', a high-grade nylon/rubber reaction moulding
- > **Maximum impact, corrosion and abrasion resistant**
- > **Long bucket life**
- > **Suitable for use with elevator belting and chain:** The reduced weight of the bucket enables extended chain life
- > **Ideal for industrial applications,** such as aggregates, cement, gypsum, coal, sand, etc

DIN 15234 IN 'NYRIM'

Industrial/Sticky

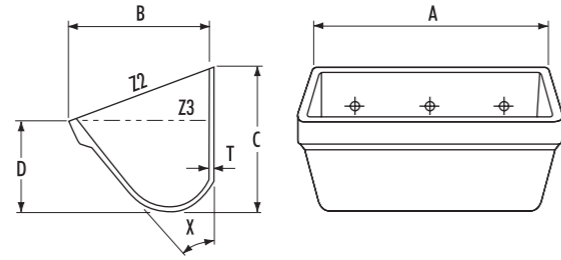

No.	Nominal Size (mm)	A (mm)	B (mm)	C (mm)	D (mm)	T (mm)	X°	Capacity (Litres)		
								(kg)	Z2 (total)	Z3 (water)
AD300	300 x 200	361	202	215	111	14	43	1.70	6.75	4.135
AD400	400 x 224	424	247	286	156	11	39	2.75	14.33	9.00
AD500	500 x 250	524	274	321	174	12	39	3.80	23.20	15.00
AD630	630 x 280	654	306	363	196	12	39	6.80	36.00	23.40

Bolt holes drilled to customer specification

ATLAS ATLAS AM



Heavy Duty Nyrim Buckets.

- > **Antistatic material** with excellent surface resistivity dissipating properties, ideal for ATEX applications
- > **Non-stick properties** are enhanced by smooth surface finish and open bucket design
- > **Ultra heavy duty design and construction:** material up to 6 times stronger than other industrial plastic buckets
- > **Versatile bucket:** suitable for heavy industrial, grain and sticky material applications

NYRIM

Agricultural & Industrial

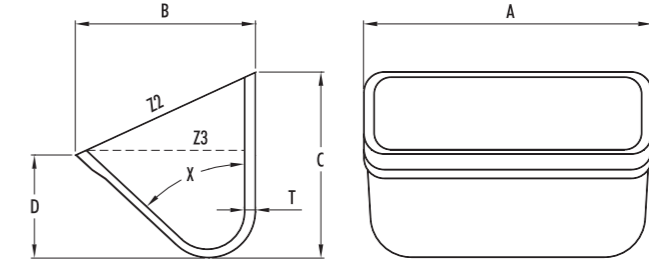

No.	A (mm)	B (mm)	C (mm)	D (mm)	T (mm)	X°	Capacity (Litres)		
							(kg)	Z2 (total)	Z3 (water)
AM320	325	262	270	155	17	47	2.9	9.4	6.4
AM420	425	262	270	155	17	47	3.5	13.9	9.6
AM520	525	262	270	155	17	47	4.2	16.6	11.5
AM620	625	262	270	155	17	47	4.9	20.0	13.8

Bolt holes drilled to customer specification



POLYPENCO NBA & DIN 15234

Polypenco 'Nylatron' cast nylon buckets are designed for tough longlife solutions for industrial applications. Polypenco buckets can be used in new installations or in retro-fit situations and are available in 2 styles/ranges: NBA - for use in relatively narrow elevator legs DIN - for elevators designed around DIN NORM 15234.

- > Heavy-duty construction with thick bucket walls
- > Impact, corrosion and abrasion resistant for a long working life
- > Suitable for both chain and bucket or belt and bucket applications
- > Non-stick quality reducing product build-up and reserving maximum elevator capacity
- > Temperature resistant: handles products up to max. 110°C

NBA & DIN 15234 IMPACT-WEAR-CORROSION RESISTANT CAST NYLATRON

Industrial/Sticky

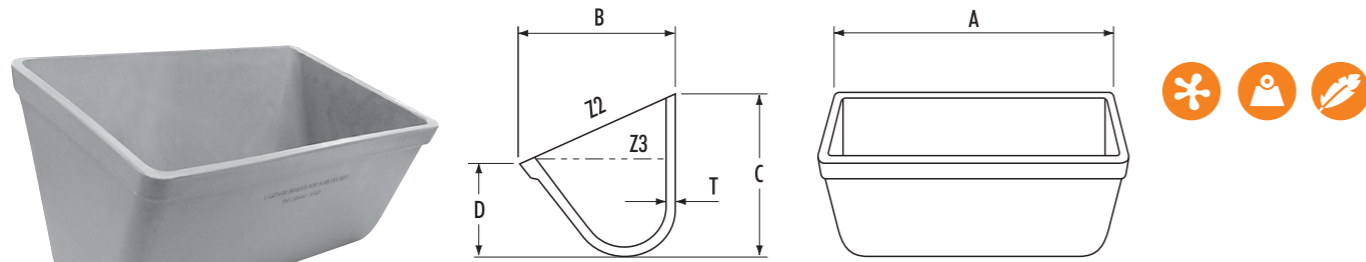

No.	A (mm)	B (mm)	C (mm)	D (mm)	T (mm)	(kg)	Capacity (Litres)	
							Z2 (total)	Z3 (water)
NBA 8	206	111	127	73	8	0.59	1.20	0.98
NBA 10	254	123	141	82	8	0.79	1.85	1.44
NBA 12	318	167	164	93	8	1.13	4.50	2.70
NBA 14	362	179	190	109	8	1.53	6.10	4.00
NBA 15	370	206	223	131	8	1.80	8.57	5.76
NBA 16	413	210	203	113	8	1.81	9.30	5.60
NBA 18	457	198	229	143	8	2.50	11.10	7.50

DIN 200/160	224	178	209	109	8	1.25	3.65	2.23
DIN 250/180	274	199	233	121	8	1.59	5.60	3.54
DIN 315/200	339	219	260	135	8	2.38	9.90	5.39
DIN 400/225	426	244	291	153	8	3.18	15.20	9.05
DIN 500/250	526	269	328	176	8	4.20	23.92	14.38
DIN 630/280	656	301	364	193	8	5.44	37.20	22.70

Bolt holes drilled to customer specification

ELEVATOR BOLTS

ASK 4B FOR OUR COMPLETE BOLTS CATALOGUE



4B EURO BOLT
For steel buckets with recessed holes use: Bolt, hexagon nut and large domed washer.



4B EURO BOLT
For steel buckets with plain holes use: Bolt, hexagon nut, small flat washer.



4B EURO BOLT
For plastic buckets you must use: Bolt, hexagon nut and large flat washer.



4B REF 70



4B LARGE OVAL WASHER



4B FANG



4B EASIFIT

SUPERGRIP BELT FASTENERS

- > Easy to fit modular system of 50mm segments
- > 4 versions available for belts up to 1250 kN/m without thickness limitation
- > Each assembly comprises 2 half joints, high tensile bolt & self-locking nut
- > With standard nylon nuts - max temp. 80° C, for temp. 80° C+ specify Philidas nuts
- > Available in stainless steel

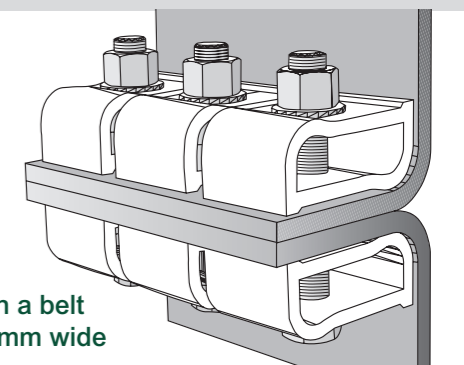

Example of joint using 3 Supergrips on a belt of 150 to 195mm wide

See Belt Catalogue for Steel Web Belt Clamps

SPECIFICATIONS

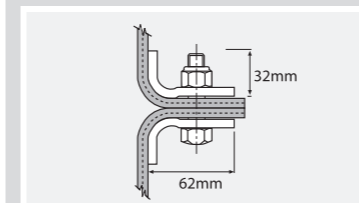

Supergrip No.1
> Belt Strength - 500kN/m max.
> Weight - 0.5Kgs
> M14 Bolts

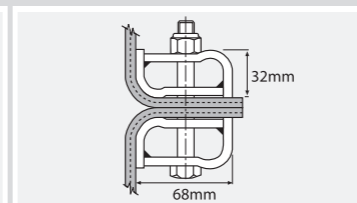

Supergrip No.2
> Belt Strength - 630kN/m max.
> Weight - 0.8Kgs
> M14 Bolts

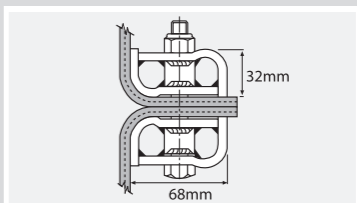

Supergrip No.3
> Belt Strength - 800kN/m max.
> Weight - 0.85Kgs
> M14 Bolts

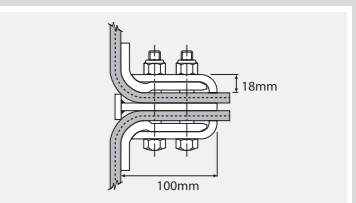

Supergrip No.4
> Belt Strength - 1250kN/m max.
> Weight - 1.83Kgs
> M16 Bolts

Bespoke belt clamps available for belts over 1250kN/m. Contact 4B's technical department



4B catalogues also available:

- Electronics
- Bolts & Fasteners
- Elevator Belting
- Forged Chains

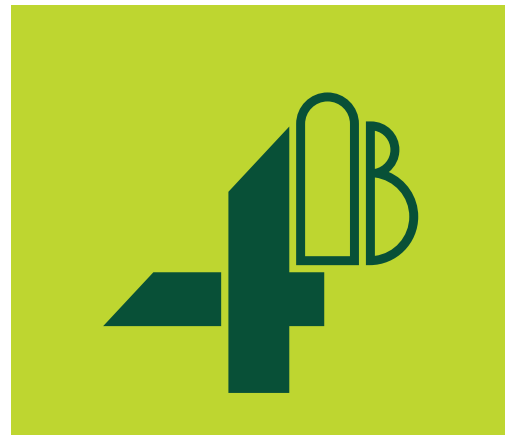

Офіційний дистриб'ютор в Україні

Тел.: (057) 714-09-09

www.irbis.ua