

# PRODUCT CATALOGUE

COMPONENTS FOR TECHNICS



# Table of Contents

FOREWORD .....	4
ABOUT PRODUCT .....	5
BEARINGS TOLERANCES CLASSES .....	7
BEARING TOLERANCES .....	8
Symbols of Boundary Dimension and Running Accuracy.....	8
Tolerance Tables (Part 1) .....	9
Tolerance Tables (Part 2) .....	10
Tolerance Tables (Part 3) .....	11
BEARINGS SERIES SYMBOLS .....	12
BEARINGS SUPPLEMENTARY DESIGNATIONS.....	13
Frequently Used Suffixes of Bearing Numbers .....	13
COMPETITIVE PRODUCTS LIST.....	15
PRODUCTS GALLERY .....	16
<b>BEARING TABLES</b>	
DEEP GROOVE BALL BEARINGS .....	19
ANGULAR CONTACT BALL BEARINGS .....	36
SELF-ALIGNING BALL BEARINGS .....	52
SPHERICAL ROLLER BEARINGS .....	58
THRUST BALL BEARINGS .....	65
THRUST SPHERICAL ROLLER BEARINGS .....	70
CYLINDRICAL ROLLER BEARINGS .....	72
TAPERED ROLLER BEARINGS .....	90
NEEDLE ROLLER BEARINGS.....	96
BEARING UNITS.....	105
<b>APPENDICES CONTENTS</b>	
TOLERANCE TABLES.....	122

## FOREWORD

CT International s.r.o. is a company of manufacturing and marketing qualitative bearings.

Our vision is to be an engineering and marketing oriented supplier of bearings, to provide our customer with the quality products at the lowest possible price.

Quality, technique, service is the target that we pursue.

With the first-class production equipment our professional team can prevent any minor mistake during the production.

Our mission is continually meeting customers' requirements and constantly providing innovative solutions to them without sacrificing quality and longevity, utilizing the latest manufacturing technologies and resources to provide the optimum balance between cost and quality.

## ABOUT PRODUCT

CT International s.r.o. is prepared to offer you a wide range of standard and specific bearings developed in accordance with industrial demands of the market.

All structural groups and types of bearings are up to the International Quality Standards.

We can help you to find the right bearing products for your application for any industry you belong.

# FREQUENTLY APPLIED TECHNICAL DATA OF BEARINGS

Bearings Tolerance Class  
Bearings Tolerance Symbols  
Tolerance Tables  
Bearings Series Symbols  
Bearings Supplementary Designations

## BEARINGS TOLERANCES CLASSES

Types of Bearings		Tolerance Classes				
Deep Groove Ball Bearings		Normal	Class 6	Class 5	Class 4	Class 2
Angular Contact Ball Bearings		Normal	Class 6	Class 5	Class 4	Class 2
Self-aligning Ball Bearings		Normal	Class 6 equivalent	Class 5 equivalent	—	—
Cylindrical Roller Bearings		Normal	Class 6	Class 5	Class 4	Class 2
Solid Type Needle Roller Bearings		Normal	Class 6	Class 5	Class 4	—
Spherical Roller Bearings		Normal	Class 6 equivalent	Class 5 equivalent	—	—
Thrust Ball Bearings		Normal	Class 6	Class 5	Class 4	—
Spherical Thrust Roller Bearings		Normal	—	—	—	—
Metric-design Tapered Roller Bearings		Normal Class 6X	—	Class 5	Class 4	—
Inch-design Tapered Roller Bearings		ABMA CLASS 4	ABMA CLASS 2	ABMA CLASS 3	ABMA CLASS 0	ABMA CLASS 00
Equivalent standards						
JIS B1514 Japanese Industrial Standard		Class 0	Class 6	Class 5	Class 4	Class 2
DIN 620 (Deutsches Institut für Normung) German Institute for Standardization		P0	P6	P5	P4	P2
ABMA American Bearing Manufacturers Association	Ball Bearings	ABEC 1	ABEC 3	ABEC 5 (CLASS 5P)	ABEC 7 (CLASS 7P)	ABEC 9 (CLASS 9P)
	Roller Bearings	RBEC 1	RBEC 3	RBEC 5	—	—
	Tapered Roller Bearings	CLASS 4	CLASS 2	CLASS 3	CLASS 0	CLASS 00

### Note

1. The majority of bearings produced by CT-international correspond to normal accuracy class and to zero accuracy class of JIS standard (please refer to ISO 492/199/582/ABEC 1).
2. Bearings may be produced at Class 6 upon requested by customers for relatively rigid applications. Please contact our sales personnel for detailed information before placing an order.



## BEARING TOLERANCES

### Symbols of Boundary Dimension and Running Accuracy

$d$	<i>Nominal bearing bore diameter</i>
$\Delta_{ds}$	<i>Deviation of single bore diameter</i>
$\Delta_{dmp}$	<i>Deviation of mean bore diameter in a single plane</i>
$V_{dp}$	<i>Variation of mean bore diameter in a single plane</i>
$V_{dmp}$	<i>Variation of mean bore diameter</i>
$B$	<i>Nominal inner ring width</i>
$\Delta_{Bs}$	<i>Deviation of single ring width</i>
$V_{Bs}$	<i>Variation of single ring width</i>
$K_{ia}$	<i>Radial runout of inner ring of assembled bearing</i>
$S_d$	<i>Runout of inner ring face to the bore</i>
$S_{ia}$	<i>Axial runout of end face to inner ring raceway of assembled bearing</i>
$S_i / S_e$	<i>Variation of washer thickness of (shaft / housing) locating washers</i>
$T$	<i>Nominal bearing height of a single direction axial bearing</i>
$D$	<i>Nominal bearing outer diameter</i>
$\Delta_{Ds}$	<i>Deviation of single outer diameter</i>
$\Delta_{Dmp}$	<i>Deviation of mean outer diameter in a single plane</i>
$V_{Dp}$	<i>Variation of single outer diameter in a single plane</i>
$V_{Dmp}$	<i>Variation of mean outer diameter</i>
$C$	<i>Nominal outer ring width</i>
$\Delta_{Cs}$	<i>Deviation of single outer ring width</i>
$V_{Cs}$	<i>Variation of outer ring width</i>
$K_{ea}$	<i>Radial runout of outer ring of assembled bearing</i>
$S_D$	<i>Runout of outer ring outside surface generatrix to the face</i>
$S_{ea}$	<i>Axial runout of end face to outer ring raceway of assembled bearing</i>

## Tolerance Tables (Part 1)

$d$ (mm)		$\Delta_{dmp}$ Deviation of Mean Bore Diameter										units : $\mu m$
		Normal		Class 6		Class 5		Class 4		Class 2		
Over	Incl.	High	Low	High	Low	High	Low	High	Low	High	Low	
0.6	2.5	0	-8	0	-7	0	-5	0	-4	0	-2.5	
2.5	10	0	-8	0	-7	0	-5	0	-4	0	-2.5	
10	18	0	-8	0	-7	0	-5	0	-4	0	-2.5	
18	30	0	-10	0	-8	0	-6	0	-5	0	-2.5	
30	50	0	-12	0	-10	0	-8	0	-6	0	-2.5	
50	80	0	-15	0	-12	0	-9	0	-7	0	-4	
80	120	0	-20	0	-15	0	-10	0	-8	0	-5	
120	150	0	-25	0	-18	0	-13	0	-10	0	-7	
150	180	0	-25	0	-18	0	-13	0	-10	0	-7	
180	250	0	-30	0	-22	0	-15	0	-12	0	-8	
250	315	0	-35	0	-25	0	-18	-	-	-	-	
315	400	0	-40	0	-30	0	-23	-	-	-	-	
400	500	0	-45	0	-35	-	-	-	-	-	-	
500	630	0	-50	0	-40	-	-	-	-	-	-	
630	800	0	-75	-	-	-	-	-	-	-	-	
800	1,000	0	-100	-	-	-	-	-	-	-	-	
1,000	1,250	0	-125	-	-	-	-	-	-	-	-	
1,250	1,600	0	-160	-	-	-	-	-	-	-	-	
1,600	2,000	0	-200	-	-	-	-	-	-	-	-	

$d$ (mm)		$V_{dmp}$ Variation of Mean Bore Diameter					$\Delta_{Bs}$ ( or $\Delta_{Cs}$ ) Deviation of Single (Outer) Ring Width												units : $\mu m$
		Normal	Class 6	Class 5	Class 4	Class 2	Single Bearing						Combined Bearings						
							Normal Class 6	Class 5 Class 4	Class 2	Normal Class 6	Class 5 Class 4	Class 2							
Over	Incl.	Max	Max	Max	Max	Max	High	Low	High	Low	High	Low	High	Low	High	Low	High	Low	
0.6	2.5	6	5	3	2	1.5	0	-40	0	-40	0	-40	-	-	0	-250	0	-250	
2.5	10	6	5	3	2	1.5	0	-120	0	-40	0	-40	0	-250	0	-250	0	-250	
10	18	6	5	3	2	1.5	0	-120	0	-80	0	-80	0	-250	0	-250	0	-250	
18	30	8	6	3	2.5	1.5	0	-120	0	-120	0	-120	0	-250	0	-250	0	-250	
30	50	9	8	4	3	1.5	0	-120	0	-120	0	-120	0	-250	0	-250	0	-250	
50	80	11	9	5	3.5	2	0	-150	0	-150	0	-150	0	-380	0	-250	0	-250	
80	120	15	11	5	4	2.5	0	-200	0	-200	0	-380	0	-380	0	-380	0	-380	
120	150	19	14	7	5	3.5	0	-250	0	-250	0	-250	0	-500	0	-380	0	-380	
150	180	19	14	7	5	3.5	0	-250	0	-250	0	-250	0	-500	0	-380	0	-380	
180	250	23	17	8	6	4	0	-300	0	-300	0	-300	0	-500	0	-500	0	-500	
250	315	26	19	9	-	-	0	-350	0	-350	-	-	0	-500	0	-500	-	-	
315	400	30	23	12	-	-	0	-400	0	-400	-	-	0	-630	0	-630	-	-	
400	500	34	26	-	-	-	0	-450	-	-	-	-	-	-	-	-	-	-	
500	630	38	30	-	-	-	0	-500	-	-	-	-	-	-	-	-	-	-	
630	800	-	-	-	-	-	0	-750	-	-	-	-	-	-	-	-	-	-	
800	1,000	-	-	-	-	-	0	-1,000	-	-	-	-	-	-	-	-	-	-	
1,000	1,250	-	-	-	-	-	0	-1,250	-	-	-	-	-	-	-	-	-	-	
1,250	1,600	-	-	-	-	-	0	-1,600	-	-	-	-	-	-	-	-	-	-	
1,600	2,000	-	-	-	-	-	0	-2,000	-	-	-	-	-	-	-	-	-	-	



## Tolerance Tables (Part 2)

<i>units : <math>\mu\text{m}</math></i>		$K_{ia}$					$S_d$			$S_{ia}$		
		Radial runout of inner ring of assembled bearing					Runout of inner ring face to the bore			Axial runout of end face to inner ring raceway of assembled bearing		
<i>d</i> (mm)		Class 0	Class 6	Class 5	Class 4	Class 2	Class 5	Class 4	Class 2	Class 5	Class 4	Class 2
Over	Incl	Max	Max	Max	Max	Max	Max	Max	Max	Max	Max	Max
0.6	2.5	10	5	4	2.5	1.5	7	3	1.5	7	3	1.5
2.5	10	10	6	4	2.5	1.5	7	3	1.5	7	3	1.5
10	18	10	7	4	2.5	1.5	7	3	1.5	7	3	1.5
18	30	13	8	4	3	2.5	8	4	1.5	8	4	2.5
30	50	15	10	5	4	2.5	8	4	1.5	8	4	2.5
50	80	20	10	5	4	2.5	8	5	1.5	8	5	2.5
80	120	25	13	6	5	2.5	9	5	2.5	9	5	2.5
120	150	30	18	8	6	2.5	10	6	2.5	10	7	2.5
150	180	30	18	8	6	5	10	6	4	10	7	5
180	250	40	20	10	8	5	11	7	5	13	8	5
250	315	50	25	13	-	-	13	-	-	15	-	-
315	400	60	30	15	-	-	15	-	-	20	-	-
400	500	65	35	-	-	-	-	-	-	-	-	-
500	630	70	40	-	-	-	-	-	-	-	-	-
630	800	80	-	-	-	-	-	-	-	-	-	-
800	1,000	90	-	-	-	-	-	-	-	-	-	-
1,000	1,250	100	-	-	-	-	-	-	-	-	-	-
1,250	1,600	120	-	-	-	-	-	-	-	-	-	-
1,600	2,000	140	-	-	-	-	-	-	-	-	-	-

<i>D</i> (mm)		$\Delta_{Dmp}$										<i>units : <math>\mu\text{m}</math></i>
		Deviation of mean outer diameter in a single plane										
Over	Incl.	Normal		Class 6		Class 5		Class 4		Class 2		
		High	Low	High	Low	High	Low	High	Low	High	Low	
2.5	6	0	-8	0	-7	0	-5	0	-4	0	-2.5	
6	18	0	-8	0	-7	0	-5	0	-4	0	-2.5	
18	30	0	-9	0	-8	0	-6	0	-5	0	-4	
30	50	0	-11	0	-9	0	-7	0	-6	0	-4	
50	80	0	-13	0	-11	0	-9	0	-7	0	-4	
80	120	0	-15	0	-13	0	-10	0	-8	0	-5	
120	150	0	-18	0	-15	0	-11	0	-9	0	-5	
150	180	0	-25	0	-18	0	-13	0	-10	0	-7	
180	250	0	-30	0	-20	0	-15	0	-11	0	-8	
250	315	0	-35	0	-25	0	-18	0	-13	0	-8	
315	400	0	-40	0	-28	0	-20	0	-15	0	-10	
400	500	0	-45	0	-33	0	-23	-	-	-	-	
500	630	0	-50	0	-38	0	-28	-	-	-	-	
630	800	0	-75	0	-45	0	-35	-	-	-	-	
800	1,000	0	-100	0	-60	-	-	-	-	-	-	
1,000	1,250	0	-125	-	-	-	-	-	-	-	-	
1,250	1,600	0	-160	-	-	-	-	-	-	-	-	
1,600	2,000	0	-200	-	-	-	-	-	-	-	-	
2,000	2,500	0	-250	-	-	-	-	-	-	-	-	

## Tolerance Tables (Part 3)

units : $\mu\text{m}$		$\Delta_{Dmp}$ Deviation of mean outer diameter in a single plane					$K_{ea}$ Radial runout of outer ring of assembled bearing					$S_D$ Runout of outer ring outside surface generatrix to the face		
		Normal Max	Class 6 Max	Class 5 Max	Class 4 Max	Class 2 Max	Normal Max	Class 6 Max	Class 5 Max	Class 4 Max	Class 2 Max	Class 5 Max	Class 4 Max	Class 2 Max
Over	Incl.													
2.5	6	6	5	3	2	1.5	15	8	5	3	1.5	8	4	1.5
6	18	6	5	3	2	1.5	15	8	5	3	1.5	8	4	1.5
18	30	7	6	3	2.5	2	15	9	6	4	2.5	8	4	1.5
30	50	8	7	4	3	2	20	10	7	5	2.5	8	4	1.5
50	80	10	8	5	3.5	2	25	13	8	5	4	8	4	1.5
80	120	11	10	5	4	2.5	35	18	10	6	5	9	5	2.5
120	150	14	11	6	5	2.5	40	20	11	7	5	10	5	2.5
150	180	19	14	7	5	3.5	45	23	13	8	5	10	5	2.5
180	250	23	15	8	6	4	50	25	15	10	7	11	7	4
250	315	26	19	9	7	4	60	30	18	11	7	13	8	5
315	400	30	21	10	8	5	70	35	20	13	8	13	10	7
400	500	34	25	12	-	-	80	40	23	-	-	15	-	-
500	630	38	29	14	-	-	100	50	25	-	-	18	-	-
630	800	55	34	18	-	-	120	60	30	-	-	20	-	-
800	1,000	75	45	-	-	-	140	75	-	-	-	-	-	-
1,000	1,250	-	-	-	-	-	160	-	-	-	-	-	-	-
1,250	1,600	-	-	-	-	-	190	-	-	-	-	-	-	-
1,600	2,000	-	-	-	-	-	220	-	-	-	-	-	-	-
2,000	2,500	-	-	-	-	-	250	-	-	-	-	-	-	-

units : $\mu\text{m}$		$D$ (mm)	$S_{ea}$ Axial runout of end face to outer ring raceway of assembled bearing			$V_{Cs}$ Variation of outer ring width		
			Class 5 Max	Class 4 Max	Class 2 Max	Class 5 Max	Class 4 Max	Class 2 Max
Over	Incl.							
2.5	6		8	5	1.5	5	2.5	1.5
6	18		8	5	1.5	5	2.5	1.5
18	30		8	5	2.5	5	2.5	1.5
30	50		8	5	2.5	5	2.5	1.5
50	80		10	5	4	6	3	1.5
80	120		11	6	5	8	4	2.5
120	150		13	7	5	8	5	2.5
150	180		14	8	5	8	5	2.5
180	250		15	10	7	10	7	4
250	315		18	10	7	11	7	5
315	400		20	13	8	13	8	7
400	500		23	-	-	15	-	-
500	630		25	-	-	18	-	-
630	800		30	-	-	20	-	-
800	1,000		-	-	-	-	-	-
1,000	1,250		-	-	-	-	-	-
1,250	1,600		-	-	-	-	-	-
1,600	2,000		-	-	-	-	-	-
2,000	2,500		-	-	-	-	-	-

## BEARINGS SERIES SYMBOLS

Types of Bearings	Bearing Series Symbols	Symbols Type	Dimension Symbols		Types of Bearings	Bearing Series Symbols	Symbols Type	Dimension Symbols		
			Width or Height Symbols	Symbols				Width or Height Symbols	Symbols	
Single-Row Deep Groove Ball Bearings	68	6	(1)	8	Single-Row Cylindrical Roller Bearings	NU10	NU	1	0	
	69	6	(1)	9		NU2	NU	(0)	2	
	60	6	(1)	0		NU22	NU	2	2	
	62	6	(0)	2		NU3	NU	(0)	3	
	63	6	(0)	3		NU23	NU	2	3	
Single Row Angular Contact Ball Bearings	79	7	(1)	9		NU4	NU	(0)	4	
	70	7	(1)	0		NJ2	NJ	(0)	2	
	72	7	(0)	2		NJ22	NJ	2	2	
	73	7	(0)	3		NJ3	NJ	(0)	3	
Self-Aligning Ball Bearings	12	1	(0)	2		NJ23	NJ	2	3	
	13	1	(0)	3		NJ4	NJ	(0)	4	
	22	(1)	2	2		NUP2	NUP	(0)	2	
	23	(1)	2	3		NUP22	NUP	2	2	
Spherical Roller Bearings	230	2	3	0		NUP3	NUP	(0)	3	
	231	2	3	1		NUP23	NUP	2	3	
	222	2	2	2		NUP4	NUP	(0)	4	
	232	2	3	2		N10	N	1	0	
	213(1)	2	0	3		N2	N	(0)	2	
	223	2	2	3		N3	N	(0)	3	
Thrust Ball Bearings	511	5	1	1		N4	N	(0)	4	
	512	5	1	2		Thrust Spherical Roller Bearings	292	2	9	2
	513	5	1	3			293	2	9	3
	514	5	1	4			294	2	9	4
	522	5	2	2	Needle Roller Bearings	NA48	N/A	4	8	
	523	5	2	3		NA49	N/A	4	9	
524	5	2	4	NA59		N/A	5	9		
329	3	2	9	NA69		N/A	6	9		
Taper Roller Bearings	320	3	2	0	Note Numbers in "( )" are normally omitted from the bearing numbers.					
	330	3	3	0						
	331	3	3	1						
	302	3	0	2						
	322	3	2	2						
	332	3	3	2						
	303	3	0	3						
	323	3	2	3						

## BEARINGS SUPPLEMENTARY DESIGNATIONS

Frequently Used Suffixes of Bearing Numbers Attribute	Supplementary Designation CT
<b>Contact Angle Symbol</b>	
Standard contact angle of 30°	
Standard contact angle of 25°	ACD
Standard contact angle of 40°	B
Standard contact angle of 15°	CD
Contact angle about 20° (only applied to Tapered Roller Bearings)	
Contact angle about 28° (only applied to Tapered Roller Bearings)	
<b>Internal Design Symbol</b>	
Internal design differs from standard	A
Smaller diameter of outer ring raceway, contact angle, and outer ring width of tapered roller bearings conform to ISO 355	J
<b>Material Symbol</b>	
Case-hardened steel used in rings, rolling elements	
Stainless steel used in rings, rolling elements	
<b>Cage Symbol</b>	
Machined brass cage	M
One-piece brass window-type cage, with punched or reamed pockets, inner or outer ring centred	MP
Synthetic resin cage	TN
Pressed steel cage	W
Without cage	V
<b>External Features - Seals, Shields Symbol</b>	
Shield on one side only	Z
Shield on both sides	2Z
Contact rubber seal on one side only	RS
Contact rubber shield on both sides	2RS
Rubber low-Friction Seals	RSH
Rubber low-Friction Seals	RSL
Rubber low-Friction Seals on both sides	2RSH
Rubber low-Friction Seals on both sides	2RSL
Non-contact rubber seal on one side only	RZ
Non-contact rubber seal on both sides	2RZ
<b>Rings Design Symbol</b>	
Tapered bore of inner ring (Taper 1:12)	K
Tapered bore of inner ring (Taper 1:30)	K30
Notch or lubricating groove ring	E
Lubricating groove in outside surface and holes in outer ring	E
Snap ring groove in outer ring	N
Snap ring groove with snap ring in outer ring	NR
<b>Bearing Arrangement Symbol</b>	
Back to back arrangement	DB
Face to face arrangement	DF
Tandem arrangement	DT
<b>Internal Clearance Symbol</b>	
Clearance less than C2	C1
Clearance less than CN	C2
Clearance CN	C0
Clearance greater than CN	C3
Clearance greater than C3	C4
Clearance greater than C4	C5
<b>Tolerance Class Symbol</b>	
ISO normal (P0 is usually omitted from the bearing numbers)	P0
ISO Class 6	P6
ISO Class 5	P5
ISO Class 4	P4
ISO Class 2	
<b>Special Specification Symbol</b>	
Working temperature lower than 150°C	S0
Working temperature lower than 200°C	S1
Working temperature lower than 250°C	S2
Dimensional stabilizing treatment working temperature lower than 200°C	S1
Double row design (Available in particular sizes only.)	ZW



# COMPETITIVE PRODUCTS & PRODUCTS GALLERY

## COMPETITIVE PRODUCTS LIST

Below listed products are technically established, available in stock or within the shortest possible delivery lead-time, and lowest requirement of minimum order. Please contact us if you are looking for something out of the list.

### Deep Groove Ball Bearings

- Single Row Deep Groove Ball Bearings
- Double Row Deep Groove Ball Bearings

### Angular Contact Ball Bearings

- Single Row Angular Contact Ball Bearings
- Double Row Angular Contact Ball Bearings
- Four Point Contact Ball Bearings

### Self-Aligning Ball Bearings

### Spherical Roller Bearings

### Thrust Ball Bearings

- Single Direction Thrust Ball Bearings
- Double Direction Thrust Ball Bearings

### Thrust Spherical Roller Bearings

### Cylindrical Roller Bearings

- Single Row Cylindrical Roller Bearings

### Tapered Roller Bearings

- Single Row Tapered Roller Bearings
- Double Row Tapered Roller Bearings

### Needle Roller Bearings

- Needle Rollers & Cage Assemblies
- Drawn Cup Needle Roller Bearings
- Solid Needle Roller Bearings

### Bearing Units

- Pillow Type Units
  - UCP Series
  - UKT Series

- Square Four Bolt Flange Type Units
  - UCF Series
  - UKF Series

- Oval Flange Type Units
  - UCFL Series
  - UKFL Series

- Round Flange Cartridge Type Units
  - UCFC Series
  - UKFC Series

- Take Up Type Units
  - UCT Series
  - UKT Series

- Ball Bearing Inserts
  - UC, SB, SU Series
  - NA Series
  - ER, RB Series

## PRODUCTS GALLERY



DEEP GROOVE BALL BEARINGS

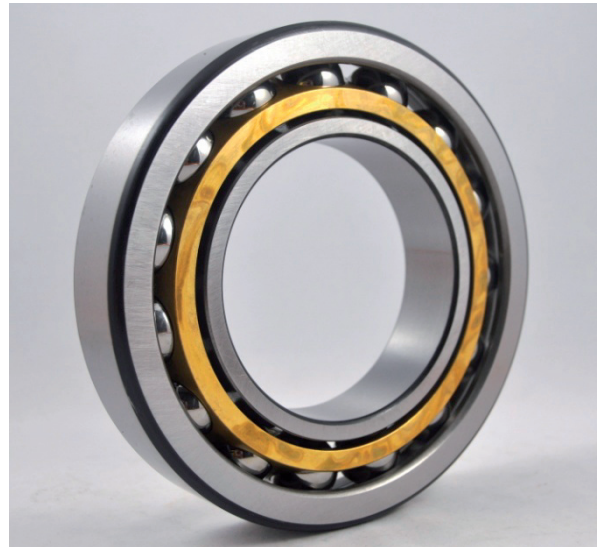

ANGULAR CONTACT BALL BEARINGS



SELF-ALIGNING BALL BEARINGS



SPHERICAL ROLLER BEARINGS



THRUST BALL BEARINGS





CYLINDRICAL ROLLER BEARINGS



TAPERED ROLLER BEARINGS



NEEDLE ROLLER BEARINGS



BEARING UNITS



# BEARING TABLES

## DEEP GROOVE BALL BEARINGS

Deep groove ball bearings are the most common type of rolling bearings and they are widely used in variety of applications, they are consequently available in many executions and sizes. Deep groove ball bearings are generally divided into 2 main types, i.e. Single row and double row.

### Single Row Deep Groove Ball Bearings

Single row deep groove ball bearings are considerably flexible in applications. They are designed to be simple, and suitable for very high speed operations, and yet required minimum level of maintenance. The balls roll in the deep raceway groove, with a great conformity between the rolling elements and the raceway has enabled it to accommodate axial loads in both directions even at high speeds, in addition to radial loads.

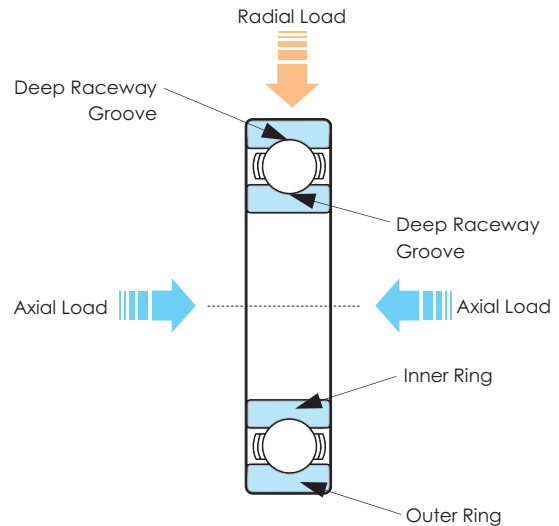

### Double Row Deep Groove Ball Bearings

The design of double row deep groove ball bearings is in correspondence to single row deep groove ball bearings. Similarly, there is high conformity between the rolling elements and the raceway, the balls roll at the deep and constant raceway groove, accommodating high axial loads in both directions. Double row deep groove ball bearings are very suitable where situation a single row deep groove ball bearing's carrying capacity is inadequate. With its' similar bore and outer diameter, double row deep groove ball bearings are slightly wider than single row bearings, but having greater capability to accommodate higher loads.

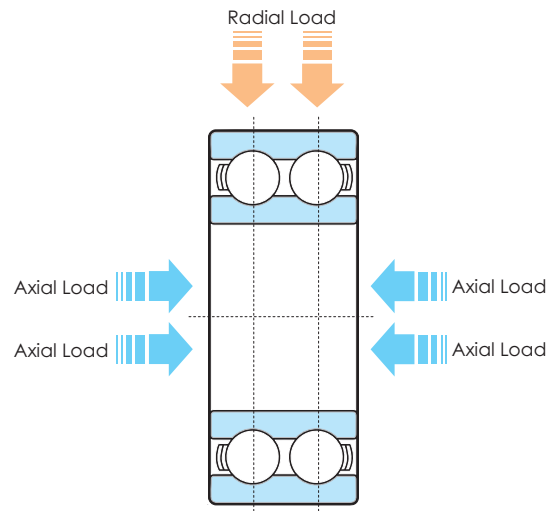

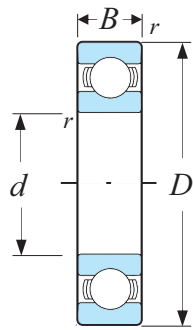

## DEEP GROOVE BALL BEARINGS

### Single Row

 Table 1  
 Bore Diameter 3mm - 7mm

Principal Dimension			Basic Load Ratings		Speed Ratings		Mass	Designations
d	D	B	Dynamic	Static	Ref. Speed	Limiting Speed		
mm			C	Co	r/min		kg	CT
			kN					
3	10	4	0,54	0,18	130000	80000	0,0015	623
3	10	4	0,54	0,18	-	40000	0,0015	623 2RS
3	10	4	0,54	0,18	130000	63000	0,0015	623 2Z
3	10	4	0,54	0,18	-	40000	0,0015	623 RS
3	10	4	0,54	0,18	130000	80000	0,0015	623 Z
4	9	2,5	0,54	0,18	140000	85000	0,0007	618/4
4	9	3,5	0,54	0,18	140000	70000	0,001	628/4 2Z
4	9	4	0,54	0,18	140000	70000	0,0013	638/4 2Z
4	11	4	0,715	0,232	130000	80000	0,0017	619/4
4	11	4	0,715	0,232	130000	63000	0,0017	619/4 2Z
4	12	4	0,806	0,28	120000	75000	0,0021	604
4	12	4	0,806	0,28	120000	60000	0,0021	604 2Z
4	12	4	0,806	0,28	120000	60000	0,0021	604 Z
4	13	5	0,936	0,29	110000	67000	0,0031	624
4	13	5	0,936	0,29	110000	53000	0,0031	624 2Z
4	13	5	0,936	0,29	110000	67000	0,0031	624 Z
4	16	5	1,11	0,38	95000	60000	0,0054	634
4	16	5	1,11	0,38	-	28000	0,0054	634 2RS
4	16	5	1,11	0,38	95000	48000	0,0054	634 2Z
4	16	5	1,11	0,38	-	28000	0,0054	634 RS
4	16	5	1,11	0,38	95000	60000	0,0054	634 RZ
4	16	5	1,11	0,38	95000	60000	0,0054	634 Z
5	11	3	0,637	0,255	120000	75000	0,0012	618/5
5	11	4	0,637	0,255	120000	60000	0,0014	628/5 2Z
5	11	5	0,637	0,255	120000	60000	0,0016	638/5 2Z
5	13	4	0,884	0,34	110000	67000	0,0025	619/5
5	13	4	0,884	0,34	110000	53000	0,0025	619/5 2Z
5	16	5	1,14	0,38	95000	60000	0,005	625
5	16	5	1,14	0,38	95000	48000	0,005	625 2Z
5	16	5	1,14	0,38	95000	60000	0,005	625 Z
5	19	6	2,34	0,95	80000	50000	0,009	635
5	19	6	2,34	0,95	-	24000	0,009	635 2RS
5	19	6	2,34	0,95	80000	40000	0,009	635 2Z
5	19	6	2,34	0,95	-	24000	0,009	635 RS
5	19	6	2,34	0,95	80000	50000	0,009	635 RZ
5	19	6	2,34	0,95	80000	50000	0,009	635 Z
6	13	3,5	0,884	0,345	110000	67000	0,002	618/6
6	13	5	0,884	0,345	110000	53000	0,0026	628/6 2Z
6	15	5	1,24	0,475	100000	63000	0,0039	619/6
6	15	5	1,24	0,475	100000	50000	0,0039	619/6 2Z
6	19	6	2,34	0,95	80000	50000	0,0084	626
6	19	6	2,34	0,95	80000	40000	0,0084	626 2Z
6	19	6	2,34	0,95	80000	50000	0,0084	626 Z
7	14	3,5	0,956	0,4	100000	63000	0,0022	618/7
7	14	5	0,956	0,4	100000	50000	0,0031	628/7 2Z
7	17	5	1,48	0,56	90000	56000	0,0049	619/7

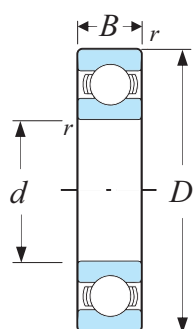

## DEEP GROOVE BALL BEARINGS

### Single Row

Table 2  
Bore Diameter 7mm - 9mm

Principal Dimension			Basic Load Ratings		Speed Ratings		Mass	Designations
d	D	B	Dynamic Static		Ref. Speed	Limiting Speed	kg	CT
mm			C	C <sub>0</sub>	r/min			
7	17	5	1,48	0,56	90000	45000	0,0049	619/7 2Z
7	19	6	2,34	0,95	85000	53000	0,0075	607
7	19	6	2,34	0,95	85000	43000	0,0075	607 2Z
7	19	6	2,34	0,95	85000	53000	0,0075	607 Z
7	22	7	3,45	1,37	70000	45000	0,013	627
7	22	7	3,45	1,37	70000	36000	0,013	627 2Z
7	22	7	3,45	1,37	70000	45000	0,013	627 Z
8	16	4	1,33	0,57	90000	56000	0,003	618/8
8	16	5	1,33	0,57	-	26000	0,0036	628/8 2RS
8	16	5	1,33	0,57	90000	45000	0,0036	628/8 2Z
8	16	6	1,33	0,57	90000	45000	0,0043	638/8 2Z
8	19	6	2,34	0,95	85000	43000	0,0072	607/8 2Z
8	19	6	2,34	0,95	85000	53000	0,0072	607/8 Z
8	19	6	1,9	0,735	80000	50000	0,0071	619/8
8	19	6	1,9	0,735	-	24000	0,0071	619/8 2RS
8	19	6	1,9	0,735	80000	40000	0,0071	619/8 2Z
8	22	7	3,45	1,37	75000	48000	0,012	608
8	22	7	3,45	1,37	75000	38000	0,012	608 2Z
8	22	7	3,45	1,37	75000	48000	0,012	608 Z
8	22	11	3,45	1,37	-	22000	0,016	630/8 2RS
8	24	8	3,9	1,66	63000	40000	0,017	628
8	24	8	3,9	1,66	-	19000	0,017	628 2RS
8	24	8	3,9	1,66	63000	32000	0,017	628 2Z
8	24	8	3,9	1,66	-	19000	0,017	628 RS
8	24	8	3,9	1,66	63000	40000	0,017	628 RZ
8	24	8	3,9	1,66	63000	40000	0,017	628 Z
8	28	9	4,62	1,96	60000	38000	0,03	638 RZ
9	17	4	1,43	0,64	85000	53000	0,0034	618/9
9	17	5	1,43	0,64	-	24000	0,0043	628/9 2RS
9	17	5	1,43	0,64	85000	43000	0,0043	628/9 2Z
9	17	5	1,43	0,64	85000	53000	0,0043	628/9 Z
9	20	6	2,08	0,865	80000	48000	0,0076	619/9
9	20	6	2,08	0,865	80000	38000	0,0076	619/9 2Z
9	24	7	3,9	1,66	70000	43000	0,014	609
9	24	7	3,9	1,66	70000	34000	0,014	609 2Z

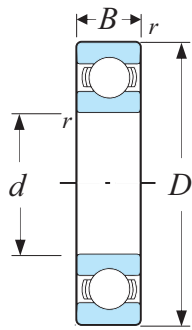

## DEEP GROOVE BALL BEARINGS

### Single Row

Table 3  
Bore Diameter 9mm - 12mm

Principal Dimension			Basic Load Ratings		Speed Ratings		Mass	Designations
d	D	B	Dynamic	Static	Ref. Speed	Limiting Speed		
mm			C	C <sub>0</sub>	r/min		kg	CT
9	24	7	3,9	1,66	70000	43000	0,014	609 Z
9	26	8	4,75	1,96	60000	38000	0,02	629
9	26	8	4,75	1,96	60000	30000	0,02	629 2Z
9	26	8	4,75	1,96	60000	38000	0,02	629 Z
10	19	5	1,38	0,585	80000	48000	0,0055	61800
10	19	5	1,38	0,585	-	22000	0,0055	61800 2RS
10	19	5	1,38	0,585	80000	38000	0,0055	61800 2Z
10	22	6	2,08	0,85	75000	45000	0,01	61900
10	22	6	2,08	0,85	-	20000	0,01	61900 2RS
10	22	6	2,08	0,85	75000	36000	0,01	61900 2Z
10	26	8	4,75	1,96	67000	40000	0,019	6000
10	26	8	4,75	1,96	67000	34000	0,019	6000 2Z
10	26	8	4,75	1,96	67000	40000	0,019	6000 Z
10	26	12	4,62	1,96	-	19000	0,025	63000 2RS
10	28	8	4,62	1,96	63000	40000	0,022	16100
10	28	8	4,62	1,96	63000	32000	0,022	16100 2Z
10	30	9	5,4	2,36	56000	34000	0,032	6200
10	30	9	5,4	2,36	56000	28000	0,032	6200 2Z
10	30	9	5,4	2,36	56000	34000	0,032	6200 Z
10	30	14	5,07	2,36	-	17000	0,04	62200 2RS
10	35	11	8,52	3,4	50000	32000	0,053	6300
10	35	11	8,52	3,4	50000	26000	0,053	6300 2Z
10	35	11	8,52	3,4	50000	32000	0,053	6300 Z
10	35	17	8,06	3,4	-	15000	0,06	62300 2RS
12	21	5	1,43	0,67	70000	43000	0,0063	61801
12	21	5	1,43	0,67	-	20000	0,0063	61801 2RS
12	21	5	1,43	0,67	70000	36000	0,0063	61801 2Z
12	24	6	2,25	0,98	67000	40000	0,011	61901
12	24	6	2,25	0,98	-	19000	0,011	61901 2RS
12	24	6	2,25	0,98	67000	32000	0,011	61901 2Z
12	28	8	5,4	2,36	60000	38000	0,022	6001

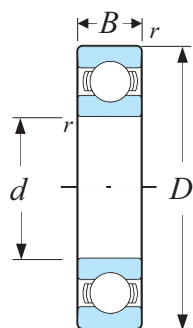

## DEEP GROOVE BALL BEARINGS Single Row

Table 4  
Bore Diameter 12mm - 15mm

Principal Dimension			Basic Load Ratings		Speed Ratings		Mass	Designations
d	D	B	Dynamic	Static	Ref. Speed	Limiting Speed		
mm			C	C <sub>0</sub>	r/min		kg	CT
12	28	8	5,4	2,36	60000	30000	0,022	6001 2Z
12	28	8	5,4	2,36	60000	38000	0,022	6001 Z
12	28	12	5,07	2,36	-	17000	0,029	63001 2RS
12	30	8	5,07	2,36	56000	34000	0,023	16101
12	30	8	5,07	2,36	-	16000	0,023	16101 2RS
12	30	8	5,07	2,36	56000	28000	0,023	16101 2Z
12	32	10	7,28	3,1	50000	32000	0,037	6201
12	32	10	7,28	3,1	50000	26000	0,037	6201 2Z
12	32	10	7,28	3,1	50000	32000	0,037	6201 Z
12	32	14	6,89	3,1	-	15000	0,045	62201 2RS
12	37	12	10,1	4,15	45000	28000	0,06	6301
12	37	12	10,1	4,15	45000	22000	0,06	6301 2Z
12	37	12	10,1	4,15	45000	28000	0,06	6301 Z
12	37	17	9,75	4,15	-	14000	0,07	62301 2RS
15	24	5	1,56	0,8	60000	38000	0,0074	61802
15	24	5	1,56	0,8	-	17000	0,0074	61802 2RS
15	24	5	1,56	0,8	60000	30000	0,0074	61802 2Z
15	28	7	4,36	2,24	56000	34000	0,016	61902
15	28	7	4,36	2,24	-	16000	0,016	61902 2RS
15	28	7	4,36	2,24	56000	28000	0,016	61902 2Z
15	32	8	5,85	2,85	50000	32000	0,025	16002
15	32	8	5,85	2,85	50000	26000	0,025	16002 2Z
15	32	8	5,85	2,85	50000	32000	0,025	16002 Z
15	32	9	5,85	2,85	50000	32000	0,03	6002
15	32	9	5,85	2,85	50000	26000	0,03	6002 2Z
15	32	9	5,85	2,85	50000	32000	0,03	6002 Z
15	32	13	5,59	2,85	-	14000	0,039	63002 2RS
15	35	11	8,06	3,75	43000	28000	0,045	6202
15	35	11	8,06	3,75	43000	22000	0,045	6202 2Z
15	35	11	8,06	3,75	43000	28000	0,045	6202 Z
15	35	14	7,8	3,75	-	13000	0,054	62202 2RS



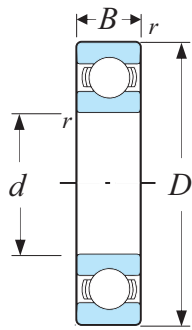

## DEEP GROOVE BALL BEARINGS

### Single Row

Table 5  
Bore Diameter 15mm - 20mm

Principal Dimension			Basic Load Ratings		Speed Ratings		Mass	Designations
d	D	B	Dynamic	Static	Ref. Speed	Limiting Speed		
mm			C	C <sub>0</sub>	r/min		kg	CT
15	42	13	11,9	5,4	38000	24000	0,082	6302
15	42	13	11,9	5,4	38000	19000	0,082	6302 2Z
15	42	13	11,9	5,4	38000	24000	0,082	6302 Z
15	42	17	11,4	5,4	-	12000	0,11	62302 2RS
17	26	5	1,68	0,93	56000	34000	0,0082	61803
17	26	5	1,68	0,93	-	16000	0,0082	61803 2RS
17	26	5	1,68	0,93	56000	28000	0,0082	61803 2Z
17	30	7	4,62	2,55	50000	32000	0,018	61903
17	30	7	4,62	2,55	-	14000	0,018	61903 2RS
17	30	7	4,62	2,55	50000	26000	0,018	61903 2Z
17	35	8	6,37	3,25	45000	28000	0,032	16003
17	35	8	6,37	3,25	45000	22000	0,032	16003 2Z
17	35	10	6,37	3,25	45000	28000	0,039	6003
17	35	10	6,37	3,25	45000	22000	0,039	6003 2Z
17	35	10	6,37	3,25	45000	28000	0,039	6003 Z
17	35	14	6,05	3,25	-	13000	0,052	63003 2RS
17	40	9	9,56	4,75	38000	24000	0,048	98203
17	40	12	9,95	4,75	38000	24000	0,065	6203
17	40	12	9,95	4,75	38000	19000	0,065	6203 2Z
17	40	12	9,95	4,75	38000	24000	0,065	6203 Z
17	40	16	9,56	4,75	-	12000	0,083	62203 2RS
17	47	14	14,3	6,55	34000	22000	0,12	6303
17	47	14	14,3	6,55	34000	17000	0,12	6303 2Z
17	47	14	14,3	6,55	34000	22000	0,12	6303 Z
17	47	19	13,5	6,55	-	11000	0,15	62303 2RS
17	62	17	22,9	10,8	28000	18000	0,27	6403
20	32	7	4,03	2,32	45000	28000	0,018	61804
20	32	7	4,03	2,32	-	13000	0,018	61804 2RS
20	37	9	6,37	3,65	43000	26000	0,038	61904
20	37	9	6,37	3,65	-	12000	0,038	61904 2RS
20	42	8	7,28	4,05	38000	24000	0,05	16004
20	42	12	9,95	5	38000	24000	0,069	6004

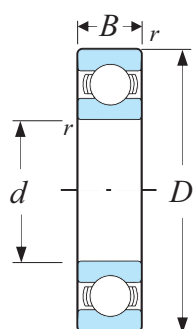

## DEEP GROOVE BALL BEARINGS Single Row

Table 6  
Bore Diameter 20mm - 25mm

Principal Dimension			Basic Load Ratings		Speed Ratings		Mass	Designations
d	D	B	Dynamic	Static	Ref. Speed	Limiting Speed		
mm			C	C <sub>0</sub>	r/min		kg	CT
20	42	12	9,95	5	38000	19000	0,069	6004 2Z
20	42	12	9,95	5	38000	24000	0,069	6004 Z
20	42	16	9,36	5	-	11000	0,086	63004 2RS
20	47	14	13,5	6,55	32000	20000	0,11	6204
20	47	14	13,5	6,55	32000	17000	0,11	6204 2Z
20	47	14	13,5	6,55	32000	20000	0,11	6204 Z
20	47	18	12,7	6,55	-	10000	0,13	62204 2RS
20	52	15	16,8	7,8	30000	19000	0,14	6304
20	52	15	16,8	7,8	30000	15000	0,14	6304 2Z
20	52	15	16,8	7,8	30000	19000	0,14	6304 Z
20	52	21	15,9	7,8	-	9500	0,2	62304 2RS
20	72	19	30,7	15	24000	15000	0,4	6404
22	50	14	14	7,65	30000	19000	0,12	62/22
22	50	14	14	7,65	-	9000	0,12	62/22 2RS
22	56	16	18,6	9,3	28000	18000	0,18	63/22
25	37	7	4,36	2,6	38000	24000	0,022	61805
25	37	7	4,36	2,6	-	11000	0,022	61805 2RS
25	42	9	7,02	4,3	36000	22000	0,045	61905
25	42	9	7,02	4,3	-	10000	0,045	61905 2RS
25	47	8	8,06	4,75	32000	20000	0,06	16005
25	47	12	11,9	6,55	32000	20000	0,08	6005
25	47	12	11,9	6,55	32000	16000	0,08	6005 2Z
25	47	12	11,9	6,55	32000	20000	0,08	6005 Z
25	47	16	11,2	6,55	-	9500	0,1	63005 2RS
25	52	15	14,8	7,8	28000	18000	0,13	6205
25	52	15	14,8	7,8	28000	14000	0,13	6205 2Z
25	52	15	14,8	7,8	28000	18000	0,13	6205 Z
25	52	18	14	7,8	-	8500	0,15	62205 2RS
25	62	17	23,4	11,6	24000	16000	0,23	6305
25	62	17	23,4	11,6	-	7500	0,23	6305 2RS

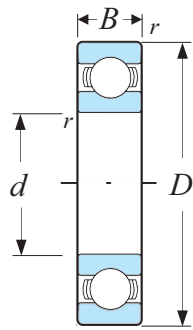

## DEEP GROOVE BALL BEARINGS

### Single Row

 Table 7  
 Bore Diameter 25mm - 35mm

Principal Dimension			Basic Load Ratings		Speed Ratings		Mass	Designations
d	D	B	Dynamic Static		Ref. Speed	Limiting Speed	kg	CT
mm			C	C <sub>0</sub>	r/min			
25	62	17	23,4	11,6	24000	13000	0,23	6305 2Z
25	62	17	23,4	11,6	-	7500	0,23	6305 RS
25	62	17	23,4	11,6	24000	16000	0,23	6305 RZ
25	62	17	23,4	11,6	24000	16000	0,23	6305 Z
25	62	24	22,5	11,6	-	7500	0,32	62305 2RS
25	80	21	35,8	19,3	20000	13000	0,53	6405
28	58	16	16,8	9,5	26000	16000	0,18	62/28
28	68	18	25,1	13,7	22000	14000	0,29	63/28
30	42	7	4,49	2,9	32000	20000	0,027	61806
30	42	7	4,49	2,9	-	9500	0,027	61806 2RS
30	47	9	7,28	4,55	30000	19000	0,051	61906
30	47	9	7,28	4,55	-	8500	0,051	61906 2RS
30	55	9	11,9	7,35	28000	17000	0,085	16006
30	55	13	13,8	8,3	28000	17000	0,12	6006
30	55	13	13,8	8,3	-	8000	0,12	6006 2RS
30	55	13	13,8	8,3	28000	14000	0,12	6006 2Z
30	55	13	13,8	8,3	-	8000	0,12	6006 RS
30	55	13	13,8	8,3	28000	17000	0,12	6006 RZ
30	55	13	13,8	8,3	28000	17000	0,12	6006 Z
30	55	19	13,3	8,3	-	8000	0,16	63006 2RS
30	62	16	20,3	11,2	24000	15000	0,2	6206
30	62	16	20,3	11,2	-	7500	0,2	6206 2RS
30	62	16	20,3	11,2	24000	12000	0,2	6206 2Z
30	62	16	20,3	11,2	-	7500	0,2	6206 RS
30	62	16	20,3	11,2	24000	15000	0,2	6206 RZ
30	62	16	20,3	11,2	24000	15000	0,2	6206 Z
30	62	20	19,5	11,2	-	7500	0,24	62206 2RS
30	72	19	29,6	16	20000	13000	0,35	6306
30	72	19	29,6	16	-	6300	0,35	6306 2RS
30	72	19	29,6	16	20000	11000	0,35	6306 2Z
30	72	19	29,6	16	-	6300	0,35	6306 RS
30	72	19	29,6	16	20000	13000	0,35	6306 RZ
30	72	19	29,6	16	20000	13000	0,35	6306 Z
30	72	27	28,1	16	-	6300	0,48	62306 2RS
30	90	23	43,6	23,6	18000	11000	0,74	6406
35	47	7	4,75	3,2	28000	18000	0,03	61807
35	47	7	4,75	3,2	-	8000	0,03	61807 2RS
35	55	10	9,56	6,8	26000	16000	0,08	61907
35	55	10	9,56	6,8	-	7500	0,08	61907 2RS
35	62	9	13	8,15	24000	15000	0,11	16007
35	62	14	16,8	10,2	24000	15000	0,16	6007
35	62	14	16,8	10,2	-	7000	0,16	6007 2RS
35	62	14	16,8	10,2	24000	12000	0,16	6007 2Z
35	62	14	16,8	10,2	-	7000	0,16	6007 RS
35	62	14	16,8	10,2	24000	15000	0,16	6007 RZ
35	62	14	16,8	10,2	24000	15000	0,16	6007 Z
35	62	20	15,9	10,2	-	7000	0,21	63007 2RS
35	72	17	27	15,3	20000	13000	0,29	6207
35	72	17	27	15,3	-	6300	0,29	6207 2RS
35	72	17	27	15,3	20000	10000	0,29	6207 2Z

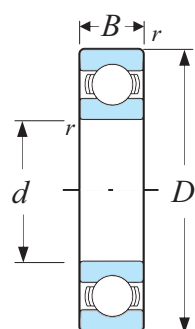

## DEEP GROOVE BALL BEARINGS

### Single Row

Table 8  
Bore Diameter 35mm - 45mm

Principal Dimension			Basic Load Ratings		Speed Ratings		Mass	Designations
d	D	B	Dynamic	Static	Ref. Speed	Limiting Speed	kg	CT
mm			C	C <sub>0</sub>	r/min			
35	72	17	27	15,3	-	6300	0,29	6207 RS
35	72	17	27	15,3	20000	13000	0,29	6207 Z
35	72	23	25,5	15,3	-	6300	0,37	62207 2RS
35	80	21	35,1	19	19000	12000	0,46	6307
35	80	21	35,1	19	-	6000	0,46	6307 2RS
35	80	21	35,1	19	19000	9500	0,46	6307 2Z
35	80	21	35,1	19	-	6000	0,46	6307 RS
35	80	21	35,1	19	19000	12000	0,46	6307 Z
35	80	31	33,2	19	-	6000	0,66	62307 2RS
35	100	25	55,3	31	16000	10000	0,95	6407
40	52	7	4,94	3,45	26000	16000	0,034	61808
40	52	7	4,94	3,45	-	7500	0,034	61808 2RS
40	62	12	13,8	10	24000	14000	0,12	61908
40	62	12	13,8	10	-	6700	0,12	61908 2RS
40	68	9	13,8	9,15	22000	14000	0,13	16008
40	68	15	17,8	11,6	22000	14000	0,19	6008
40	68	15	17,8	11,6	-	6300	0,19	6008 2RS
40	68	15	17,8	11,6	22000	11000	0,19	6008 2Z
40	68	15	17,8	11,6	-	6300	0,19	6008 RS
40	68	15	17,8	11,6	22000	14000	0,19	6008 RZ
40	68	15	17,8	11,6	22000	14000	0,19	6008 Z
40	68	21	16,8	11,6	-	6300	0,26	63008 2RS
40	80	18	32,5	19	18000	11000	0,37	6208
40	80	18	32,5	19	-	5600	0,37	6208 2RS
40	80	18	32,5	19	18000	9000	0,37	6208 2Z
40	80	18	32,5	19	-	5600	0,37	6208 RS
40	80	18	32,5	19	18000	11000	0,37	6208 RZ
40	80	18	32,5	19	18000	11000	0,37	6208 Z
40	80	23	30,7	19	-	5600	0,44	62208 2RS
40	90	23	42,3	24	17000	11000	0,63	6308
40	90	23	42,3	24	-	5000	0,63	6308 2RS
40	90	23	42,3	24	17000	8500	0,63	6308 2Z
40	90	23	42,3	24	-	5000	0,63	6308 RS
40	90	23	42,3	24	17000	11000	0,63	6308 RZ
40	90	23	42,3	24	17000	11000	0,63	6308 Z
40	90	33	41	24	-	5000	0,89	62308 2RS
40	110	27	63,7	36,5	14000	9000	1,25	6408
45	58	7	6,63	6,1	22000	14000	0,04	61809
45	58	7	6,63	6,1	-	6700	0,04	61809 2RS
45	68	12	14	10,8	20000	13000	0,14	61909
45	68	12	14	10,8	-	6000	0,14	61909 2RS
45	75	10	16,5	10,8	20000	12000	0,17	16009
45	75	16	22,1	14,6	20000	12000	0,25	6009
45	75	16	22,1	14,6	-	5600	0,25	6009 2RS
45	75	16	22,1	14,6	20000	10000	0,25	6009 2Z
45	75	16	22,1	14,6	-	5600	0,25	6009 RS
45	75	16	22,1	14,6	20000	12000	0,25	6009 Z
45	75	23	20,8	14,6	-	5600	0,34	63009 2RS
45	85	19	35,1	21,6	17000	11000	0,41	6209
45	85	19	35,1	21,6	-	5000	0,41	6209 2RS

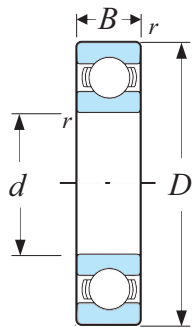

## DEEP GROOVE BALL BEARINGS

### Single Row

Table 9  
Bore Diameter 45mm - 55mm

Principal Dimension			Basic Load Ratings		Speed Ratings		Mass	Designations
d	D	B	C	C <sub>0</sub>	Ref. Speed	Limiting Speed		
mm			kN		r/min		kg	CT
45	85	19	35,1	21,6	17000	8500	0,41	6209 2Z
45	85	19	35,1	21,6	-	5000	0,41	6209 RS
45	85	19	35,1	21,6	17000	11000	0,41	6209 Z
45	85	23	33,2	21,6	-	5000	0,48	62209 2RS
45	100	25	55,3	31,5	15000	9500	0,83	6309
45	100	25	55,3	31,5	-	4500	0,83	6309 2RS
45	100	25	55,3	31,5	15000	7500	0,83	6309 2Z
45	100	25	55,3	31,5	-	4500	0,83	6309 RS
45	100	25	55,3	31,5	15000	9500	0,83	6309 Z
45	100	36	52,7	31,5	-	4500	1,15	62309 2RS
45	120	29	76,1	45	13000	8500	1,55	6409
50	65	7	6,76	6,8	20000	13000	0,052	61810
50	65	7	6,76	6,8	-	6000	0,052	61810 2RS
50	72	12	14,6	11,8	19000	12000	0,14	61910
50	72	12	14,6	11,8	-	5600	0,14	61910 2RS
50	80	10	16,8	11,4	18000	11000	0,18	16010
50	80	16	22,9	16	18000	11000	0,26	6010
50	80	16	22,9	16	-	5000	0,26	6010 2RS
50	80	16	22,9	16	18000	9000	0,26	6010 2Z
50	80	16	22,9	16	-	5000	0,26	6010 RS
50	80	16	22,9	16	18000	11000	0,26	6010 RZ
50	80	16	22,9	16	18000	11000	0,26	6010 Z
50	80	23	21,6	16	-	5000	0,37	63010 2RS
50	90	20	37,1	23,2	15000	10000	0,46	6210
50	90	20	37,1	23,2	-	4800	0,46	6210 2RS
50	90	20	37,1	23,2	15000	8000	0,46	6210 2Z
50	90	20	37,1	23,2	-	4800	0,46	6210 RS
50	90	20	37,1	23,2	15000	10000	0,46	6210 RZ
50	90	20	37,1	23,2	15000	10000	0,46	6210 Z
50	90	23	35,1	23,2	-	4800	0,52	62210 2RS
50	110	27	65	38	13000	8500	1,05	6310
50	110	27	65	38	-	4300	1,05	6310 2RS
50	110	27	65	38	13000	6700	1,05	6310 2Z
50	110	27	65	38	-	4300	1,05	6310 RS
50	110	27	65	38	13000	8500	1,05	6310 Z
50	110	40	61,8	38	-	4300	1,55	62310 2RS
50	130	31	87,1	52	12000	7500	1,9	6410
55	72	9	9,04	8,8	19000	12000	0,083	61811
55	72	9	9,04	8,8	-	5300	0,083	61811 2RS
55	80	13	16,5	14	17000	11000	0,19	61911
55	80	13	16,5	14	-	5000	0,19	61911 2RS
55	90	11	20,3	14	16000	10000	0,26	16011
55	90	18	29,6	21,2	16000	10000	0,39	6011
55	90	18	29,6	21,2	-	4500	0,39	6011 2RS
55	90	18	29,6	21,2	16000	8000	0,39	6011 2Z
55	90	18	29,6	21,2	-	4500	0,39	6011 RS
55	90	18	29,6	21,2	16000	10000	0,39	6011 Z
55	100	21	46,2	29	14000	9000	0,61	6211
55	100	21	46,2	29	-	4300	0,61	6211 2RS
55	100	21	46,2	29	14000	7000	0,61	6211 2Z

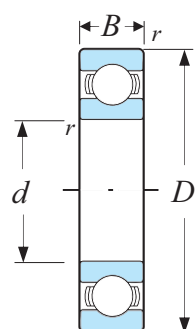

## DEEP GROOVE BALL BEARINGS

### Single Row

Table 10  
Bore Diameter 55mm - 65mm

Principal Dimension			Basic Load Ratings		Speed Ratings		Mass	Designations
d	D	B	Dynamic Static		Ref. Speed	Limiting Speed	kg	CT
mm			C	C <sub>0</sub>	r/min			
55	100	21	46,2	29	-	4300	0,61	6211 RS
55	100	21	46,2	29	14000	9000	0,61	6211 Z
55	100	25	43,6	29	-	4300	0,7	62211 2RS
55	120	29	74,1	45	12000	8000	1,35	6311
55	120	29	74,1	45	-	3800	1,35	6311 2RS
55	120	29	74,1	45	12000	6300	1,35	6311 2Z
55	120	29	74,1	45	-	3800	1,35	6311 RS
55	120	29	74,1	45	12000	8000	1,35	6311 Z
55	120	43	71,5	45	-	3800	1,95	62311 2RS
55	140	33	99,5	62	11000	7000	2,3	6411
60	78	10	11,9	11,4	17000	11000	0,11	61812
60	78	10	11,9	11,4	-	4800	0,11	61812 2RS
60	85	13	16,5	14,3	16000	10000	0,2	61912
60	85	13	16,5	14,3	-	4500	0,2	61912 2RS
60	95	11	20,8	15	15000	9500	0,28	16012
60	95	18	30,7	23,2	15000	9500	0,42	6012
60	95	18	30,7	23,2	-	4300	0,42	6012 2RS
60	95	18	30,7	23,2	15000	7500	0,42	6012 2Z
60	95	18	30,7	23,2	-	4300	0,42	6012 RS
60	95	18	30,7	23,2	15000	9500	0,42	6012 RZ
60	95	18	30,7	23,2	15000	9500	0,42	6012 Z
60	110	22	55,3	36	13000	8000	0,78	6212
60	110	22	55,3	36	-	4000	0,78	6212 2RS
60	110	22	55,3	36	13000	6300	0,78	6212 2Z
60	110	22	55,3	36	-	4000	0,78	6212 RS
60	110	22	55,3	36	13000	8000	0,78	6212 Z
60	110	28	52,7	36	-	4000	0,97	62212 2RS
60	130	31	85,2	52	11000	7000	1,7	6312
60	130	31	85,2	52	-	3400	1,7	6312 2RS
60	130	31	85,2	52	11000	5600	1,7	6312 2Z
60	130	31	85,2	52	-	3400	1,7	6312 RS
60	130	31	85,2	52	11000	7000	1,7	6312 Z
60	130	46	81,9	52	-	3400	2,5	62312 2RS
60	150	35	108	69,5	10000	6300	2,75	6412
65	85	10	12,4	12,7	16000	10000	0,13	61813
65	85	10	12,4	12,7	-	4500	0,13	61813 2RS
65	90	13	17,4	16	15000	9500	0,22	61913
65	90	13	17,4	16	-	4300	0,22	61913 2RS
65	100	11	22,5	16,6	14000	9000	0,3	16013
65	100	18	31,9	25	14000	9000	0,44	6013
65	100	18	31,9	25	-	4000	0,44	6013 2RS
65	100	18	31,9	25	14000	7000	0,44	6013 2Z
65	100	18	31,9	25	-	4000	0,44	6013 RS
65	100	18	31,9	25	14000	9000	0,44	6013 Z
65	120	23	58,5	40,5	12000	7500	0,99	6213
65	120	23	58,5	40,5	-	3600	0,99	6213 2RS
65	120	23	58,5	40,5	12000	6000	0,99	6213 2Z
65	120	23	58,5	40,5	-	3600	0,99	6213 RS
65	120	23	58,5	40,5	12000	7500	0,99	6213 Z
65	120	31	55,9	40,5	-	3600	1,25	62213 2RS

## DEEP GROOVE BALL BEARINGS

### Single Row

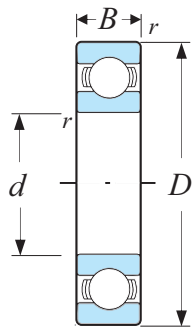
 Table 11  
 Bore Diameter 65mm - 75mm

Principal Dimension			Basic Load Ratings		Speed Ratings		Mass	Designations
d	D	B	Dynamic Static		Ref. Speed	Limiting Speed		
mm			C	C <sub>0</sub>			r/min	kg
65	140	33	97,5	60	10000	6700	2,1	6313
65	140	33	97,5	60	-	3200	2,1	6313 2RS
65	140	33	97,5	60	10000	5300	2,1	6313 2Z
65	140	33	97,5	60	-	3200	2,1	6313 RS
65	140	33	97,5	60	10000	6700	2,1	6313 Z
65	140	48	92,3	60	-	3200	3	62313 2RS
65	160	37	119	78	9500	6000	3,3	6413
70	90	10	12,4	13,2	15000	9000	0,14	61814
70	90	10	12,4	13,2	-	4300	0,14	61814 2RS
70	100	16	23,8	21,2	14000	8500	0,35	61914
70	100	16	23,8	21,2	-	4000	0,35	61914 2RS
70	110	13	29,1	25	13000	8000	0,43	16014
70	110	20	39,7	31	13000	8000	0,6	6014
70	110	20	39,7	31	-	3600	0,6	6014 2RS
70	110	20	39,7	31	13000	6300	0,6	6014 2Z
70	110	20	39,7	31	-	3600	0,6	6014 RS
70	110	20	39,7	31	13000	8000	0,6	6014 Z
70	125	24	63,7	45	11000	7000	1,05	6214
70	125	24	63,7	45	-	3400	1,1	6214 2RS
70	125	24	63,7	45	11000	5600	1,1	6214 2Z
70	125	24	63,7	45	-	3400	1,1	6214 RS
70	125	24	63,7	45	11000	7000	1,1	6214 Z
70	125	31	60,5	45	-	3400	1,3	62214 2RS
70	150	35	111	68	9500	6300	2,5	6314
70	150	35	111	68	-	3000	2,5	6314 2RS
70	150	35	111	68	9500	5000	2,5	6314 2Z
70	150	35	111	68	-	3000	2,5	6314 RS
70	150	35	111	68	9500	6300	2,5	6314 Z
70	150	51	104	68	-	3000	3,55	62314 2RS
70	180	42	143	104	8500	5300	4,85	6414
75	95	10	12,7	14,3	14000	8500	0,15	61815
75	95	10	12,7	14,3	-	4000	0,15	61815 2RS
75	105	16	24,2	19,3	13000	8000	0,37	61915
75	105	16	24,2	19,3	-	3600	0,37	61915 2RS
75	110	12	28,6	27	13000	8000	0,38	16115
75	115	13	30,2	27	12000	7500	0,46	16015
75	115	20	41,6	33,5	12000	7500	0,64	6015
75	115	20	41,6	33,5	-	3400	0,64	6015 2RS
75	115	20	41,6	33,5	12000	6000	0,64	6015 2Z
75	115	20	41,6	33,5	-	3400	0,64	6015 RS
75	115	20	41,6	33,5	12000	7500	0,64	6015 RZ
75	115	20	41,6	33,5	12000	7500	0,64	6015 Z
75	130	25	68,9	49	10000	6700	1,2	6215
75	130	25	68,9	49	-	3200	1,2	6215 2RS
75	130	25	68,9	49	10000	5300	1,2	6215 2Z
75	130	25	68,9	49	-	3200	1,2	6215 RS
75	130	25	68,9	49	10000	6700	1,2	6215 Z
75	160	37	119	76,5	9000	5600	3	6315
75	160	37	119	76,5	-	2800	3	6315 2RS
75	160	37	119	76,5	9000	4500	3	6315 2Z



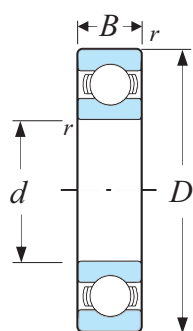

## DEEP GROOVE BALL BEARINGS Single Row

Table 12  
Bore Diameter 75mm - 90mm

Principal Dimension			Basic Load Ratings		Speed Ratings		Mass	Designations
d	D	B	Dynamic Static		Ref. Speed	Limiting Speed	kg	CT
mm			C	C <sub>0</sub>	r/min			
75	160	37	119	76,5	-	2800	3	6315 RS
75	160	37	119	76,5	9000	5600	3	6315 Z
75	190	45	153	114	8000	5000	6,8	6415
80	100	10	13	15	13000	8000	0,15	61816
80	100	10	13	15	-	3600	0,15	61816 2RS
80	110	16	25,1	20,4	12000	7500	0,4	61916
80	110	16	25,1	20,4	-	3400	0,4	61916 2RS
80	125	14	35,1	31,5	11000	7000	0,6	16016
80	125	22	49,4	40	11000	7000	0,85	6016
80	125	22	49,4	40	-	3200	0,85	6016 2RS
80	125	22	49,4	40	11000	5600	0,85	6016 2Z
80	125	22	49,4	40	-	3200	0,85	6016 RS
80	125	22	49,4	40	11000	7000	0,85	6016 Z
80	140	26	72,8	55	9500	6000	1,4	6216
80	140	26	72,8	55	-	3000	1,4	6216 2RS
80	140	26	72,8	55	9500	4800	1,4	6216 2Z
80	140	26	72,8	55	-	3000	1,4	6216 RS
80	140	26	72,8	55	9500	6000	1,4	6216 Z
80	170	39	130	86,5	8500	5300	3,6	6316
80	170	39	130	86,5	-	2600	3,6	6316 2RS
80	170	39	130	86,5	8500	4300	3,6	6316 2Z
80	170	39	130	86,5	-	2600	3,6	6316 RS
80	170	39	130	86,5	8500	5300	3,6	6316 Z
80	200	48	163	125	7500	4800	8	6416
85	110	13	19,5	20,8	12000	7500	0,27	61817
85	110	13	19,5	20,8	-	3400	0,27	61817 2RS
85	120	18	31,9	30	11000	7000	0,55	61917
85	130	14	35,8	33,5	11000	6700	0,63	16017
85	130	22	52	43	11000	6700	0,89	6017
85	130	22	52	43	-	3000	0,89	6017 2RS
85	130	22	52	43	11000	5300	0,89	6017 2Z
85	130	22	52	43	-	3000	0,89	6017 RS
85	130	22	52	43	11000	6700	0,89	6017 Z
85	150	28	87,1	64	9000	5600	1,8	6217
85	150	28	87,1	64	-	2800	1,8	6217 2RS
85	150	28	87,1	64	9000	4500	1,8	6217 2Z
85	150	28	87,1	64	-	2800	1,8	6217 RS
85	150	28	87,1	64	9000	5600	1,8	6217 Z
85	180	41	140	96,5	8000	5000	4,25	6317
85	180	41	140	96,5	-	2400	4,25	6317 2RS
85	180	41	140	96,5	8000	4000	4,25	6317 2Z
85	180	41	140	96,5	-	2400	4,25	6317 RS
85	180	41	140	96,5	8000	5000	4,25	6317 Z
85	210	52	174	137	7000	4500	9,5	6417
90	115	13	19,5	22	11000	7000	0,28	61818
90	115	13	19,5	22	-	3200	0,28	61818 2RS
90	125	18	33,2	31,5	11000	6700	0,59	61918
90	140	16	43,6	39	10000	6300	0,85	16018
90	140	24	60,5	50	10000	6300	1,15	6018
90	140	24	60,5	50	-	2800	1,15	6018 2RS

## DEEP GROOVE BALL BEARINGS Single Row

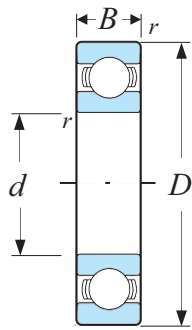
 Table 13  
Bore Diameter 90mm - 100mm

Principal Dimension			Basic Load Ratings		Speed Ratings		Mass	Designations
d	D	B	Dynamic Static		Ref. Speed	Limiting Speed	kg	CT
mm			C	C <sub>0</sub>	r/min			
90	140	24	60,5	50	10000	5000	1,15	6018 2Z
90	140	24	60,5	50	-	2800	1,15	6018 RS
90	140	24	60,5	50	10000	6300	1,15	6018 Z
90	160	30	101	73,5	8500	5300	2,15	6218
90	160	30	101	73,5	-	2600	2,15	6218 2RS
90	160	30	101	73,5	8500	4300	2,15	6218 2Z
90	160	30	101	73,5	-	2600	2,15	6218 RS
90	160	30	101	73,5	8500	5300	2,15	6218 Z
90	190	43	151	108	7500	4800	4,9	6318
90	190	43	151	108	-	2400	4,9	6318 2RS
90	190	43	151	108	7500	3800	4,9	6318 2Z
90	190	43	151	108	-	2400	4,9	6318 RS
90	190	43	151	108	7500	4800	4,9	6318 Z
90	225	54	186	150	6700	4300	11,5	6418
95	120	13	19,9	22,8	11000	6700	0,3	61819
95	120	13	19,9	22,8	-	3000	0,3	61819 2RS
95	130	18	33,8	33,5	10000	6300	0,61	61919
95	130	18	33,8	33,5	-	3000	0,61	61919 2RS
95	145	16	44,8	41,5	9500	6000	0,89	6019
95	145	24	63,7	54	9500	6000	1,2	6019
95	145	24	63,7	54	-	2800	1,2	6019 2RS
95	145	24	63,7	54	9500	4800	1,2	6019 2Z
95	145	24	63,7	54	-	2800	1,2	6019 RS
95	145	24	63,7	54	9500	6000	1,2	6019 Z
95	170	32	114	81,5	8000	5000	2,6	6219
95	170	32	114	81,5	-	2400	2,6	6219 2RS
95	170	32	114	81,5	8000	4000	2,6	6219 2Z
95	170	32	114	81,5	-	2400	2,6	6219 RS
95	170	32	114	81,5	8000	5000	2,6	6219 Z
95	200	45	159	118	7000	4500	5,65	6319
95	200	45	159	118	-	2200	5,65	6319 2RS
95	200	45	159	118	7000	3600	5,65	6319 2Z
95	200	45	159	118	-	2200	5,65	6319 RS
95	200	45	159	118	7000	4500	5,65	6319 Z
100	125	13	19,9	24	10000	6300	0,31	61820
100	125	13	19,9	24	-	3000	0,31	61820 2RS
100	140	20	42,3	41	9500	6000	0,83	61920
100	150	16	46,2	44	9500	5600	0,91	6020
100	150	24	63,7	54	9500	5600	1,25	6020
100	150	24	63,7	54	-	2600	1,25	6020 2RS
100	150	24	63,7	54	9500	4500	1,25	6020 2Z
100	150	24	63,7	54	-	2600	1,25	6020 RS
100	150	24	63,7	54	9500	5600	1,25	6020 Z
100	180	34	127	93	7500	4800	3,15	6220
100	180	34	127	93	-	2400	3,15	6220 2RS
100	180	34	127	93	7500	3800	3,15	6220 2Z
100	180	34	127	93	-	2400	3,15	6220 RS
100	180	34	127	93	7500	4800	3,15	6220 Z
100	215	47	174	140	6700	4300	7	6320
100	215	47	174	140	6700	3400	7	6320 2Z

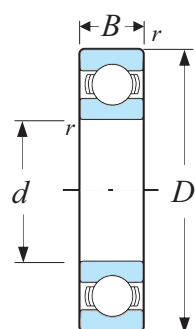

## DEEP GROOVE BALL BEARINGS Single Row

Table 14  
Bore Diameter 100mm - 130mm

Principal Dimension			Basic Load Ratings		Speed Ratings		Mass	Designations
d	D	B	Dynamic Static		Ref. Speed	Limiting Speed	kg	CT
mm			C	C <sub>0</sub>	r/min			
100	215	47	174	140	6700	4300	7	6320 Z
105	130	13	20,8	19,6	10000	6300	0,32	61821
105	130	13	20,8	19,6	-	2800	0,32	61821 2RS
105	145	20	44,2	44	9500	5600	0,87	61921
105	160	18	54	51	8500	5300	1,2	16021
105	160	26	76,1	65,5	8500	5300	1,6	6021
105	160	26	76,1	65,5	-	2400	1,6	6021 2RS
105	160	26	76,1	65,5	8500	4300	1,6	6021 2Z
105	160	26	76,1	65,5	-	2400	1,6	6021 RS
105	160	26	76,1	65,5	8500	5300	1,6	6021 Z
105	190	36	140	104	7000	4500	3,7	6221
105	190	36	140	104	-	2200	3,7	6221 2RS
105	190	36	140	104	7000	3600	3,7	6221 2Z
105	190	36	140	104	-	2200	3,7	6221 RS
105	190	36	140	104	7000	4500	3,7	6221 Z
105	225	49	182	153	6300	4000	8,25	6321
105	225	49	182	153	6300	3200	8,25	6321 2Z
105	225	49	182	153	6300	4000	8,25	6321 Z
110	140	16	28,1	26	9500	5600	0,6	61822
110	140	16	28,1	26	-	2600	0,6	61822 2RS
110	150	20	43,6	45	9000	5600	0,9	61922
110	170	19	60,2	57	8000	5000	1,45	16022
110	170	28	85,2	73,5	8000	5000	1,95	6022
110	170	28	85,2	73,5	-	2400	1,95	6022 2RS
110	170	28	85,2	73,5	8000	4000	1,95	6022 2Z
110	170	28	85,2	73,5	-	2400	1,95	6022 RS
110	170	28	85,2	73,5	8000	5000	1,95	6022 Z
110	200	38	151	118	6700	4300	4,35	6222
110	200	38	151	118	6700	3400	4,35	6222 2Z
110	200	38	151	118	6700	4300	4,35	6222 Z
110	240	50	203	180	6000	3800	9,55	6322
120	150	16	29,1	28	8500	5300	0,65	61824
120	150	16	29,1	28	-	2400	0,65	61824 2RS
120	165	22	55,3	57	8000	5000	1,2	61924
120	180	19	63,7	64	7500	4800	1,6	16024
120	180	28	88,4	80	7500	4800	2,05	6024
120	180	28	88,4	80	-	2200	2,05	6024 2RS
120	180	28	88,4	80	7500	3800	2,05	6024 2Z
120	180	28	88,4	80	-	2200	2,05	6024 RS
120	180	28	88,4	80	7500	4800	2,05	6024 Z
120	215	40	146	118	6300	4000	5,15	6224
120	215	40	146	118	6300	3200	5,15	6224 2Z
120	215	40	146	118	6300	4000	5,15	6224 Z
120	260	55	208	186	5600	3400	12,5	6324
130	165	18	37,7	43	8000	4800	0,93	61826
130	165	18	37,7	43	-	2200	0,93	61826 2RS
130	180	24	65	67	7500	4500	1,85	61926
130	200	22	83,2	81,5	7000	4300	2,35	16026
130	200	33	112	100	7000	4300	3,15	6026
130	200	33	112	100	-	2000	3,15	6026 2RS

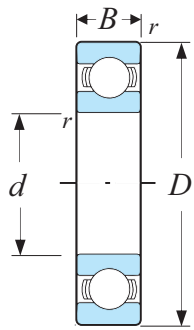

## DEEP GROOVE BALL BEARINGS

### Single Row

Table 15  
Bore Diameter 130mm - 150mm

Principal Dimension			Basic Load Ratings		Speed Ratings		Mass	Designations
d	D	B	Dynamic	Static	Ref. Speed	Limiting Speed		
mm			C	C <sub>0</sub>	r/min		kg	CT
			kN					
130	200	33	112	100	7000	3400	3,15	6026 2Z
130	200	33	112	100	-	2000	3,15	6026 RS
130	200	33	112	100	7000	4300	3,15	6026 Z
130	230	40	156	132	5600	3600	5,8	6226
130	230	40	156	132	5600	3000	5,8	6226 2Z
130	230	40	156	132	5600	3600	5,8	6226 Z
140	175	18	39	46,5	7500	4500	0,99	61828
140	175	18	39	46,5	-	2000	0,99	61828 2RS
140	210	33	111	108	6700	4000	3,35	6028
140	210	33	111	108	-	1800	3,35	6028 2RS
140	210	33	111	108	6700	3200	3,35	6028 2Z
140	210	33	111	108	-	1800	3,35	6028 RS
140	210	33	111	108	6700	4000	3,35	6028 Z
140	250	42	165	150	5300	3400	7,45	6228
150	190	20	48,8	61	6700	4300	1,4	61830
150	225	24	92,2	98	6000	3800	3,15	16030
150	225	35	125	125	6000	3800	4,8	6030
150	225	35	125	125	-	1700	4,8	6030 2RS
150	225	35	125	125	6000	3000	4,8	6030 2Z
150	225	35	125	125	-	1700	4,8	6030 RS
150	225	35	125	125	6000	3800	4,8	6030 Z
150	270	45	174	166	5000	3200	9,4	6230

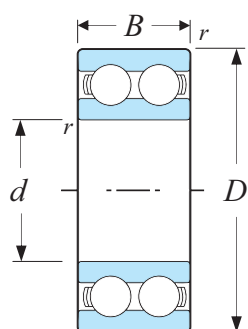

## DEEP GROOVE BALL BEARINGS

### Double Row

Table 16  
Bore Diameter 10mm - 100mm

Principal Dimension			Basic Load Ratings		Speed Ratings		Mass	Designations
d	D	B	Dynamic	Static	Ref. Speed	Limiting Speed		
mm			C	C <sub>0</sub>	r/min		kg	CT
10	30	14	9,23	5,2	40000	22000	0,049	4200
12	32	14	10,6	6,2	36000	20000	0,053	4201
12	37	17	13	7,8	34000	18000	0,092	4301
15	35	14	11,9	7,5	32000	17000	0,059	4202
15	42	17	14,8	9,5	28000	15000	0,12	4302
17	40	16	14,8	9,5	28000	15000	0,09	4203
17	47	19	19,5	13,2	24000	13000	0,16	4303
20	47	18	17,8	12,5	24000	13000	0,14	4204
20	52	21	23,4	16	22000	12000	0,21	4304
25	52	18	19	14,6	20000	11000	0,16	4205
25	62	24	31,9	22,4	18000	10000	0,34	4305
30	62	20	26	20,8	17000	9500	0,26	4206
30	72	27	41	30	16000	8500	0,5	4306
35	72	23	35,1	28,5	15000	8000	0,4	4207
35	80	31	50,7	38	14000	7500	0,69	4307
40	80	23	37,1	32,5	13000	7000	0,5	4208
40	90	33	55,9	45	12000	6700	0,95	4308
45	85	23	39	36	12000	6700	0,54	4209
45	100	36	68,9	56	11000	6000	1,25	4309
50	90	23	41	40	11000	6000	0,58	4210
50	110	40	81,9	69,5	10000	5300	1,7	4310
55	100	25	44,9	44	10000	5600	0,8	4211
55	120	43	97,5	83	9000	5000	2,15	4311
60	110	28	57,2	55	9500	5300	1,1	4212
60	130	46	112	98	8500	4500	2,65	4312
65	120	31	67,6	67	8500	4800	1,45	4213
65	140	48	121	106	8000	4300	3,25	4313
70	125	31	70,2	73,5	8000	4300	1,5	4214
70	150	51	138	125	7000	3800	3,95	4314
75	130	31	72,8	80	7500	4000	1,6	4215
75	160	55	156	143	6700	3600	4,8	4315
80	140	33	80,6	90	7000	3800	2	4216
85	150	36	93,6	102	7000	3600	2,55	4217
90	160	40	112	122	6300	3400	3,2	4218
100	180	46	140	156	5600	3000	4,7	4220

## ANGULAR CONTACT BALL BEARINGS

The raceway between the inner and outer ring of an angular contact ball bearing has certain offset angle in the direction of the bearing axis. It attributes that it is designed to carry combined loads. The combined loads are the simultaneously acting radial and axial loads. The offset angle between the raceway of inner and outer rings creates a contact angle, the greater contact angle creates greater axial loads carrying capacity. The contact angle ( $\alpha$ ) is defined as the angle between the ball and the raceways at the radial plane. The angle of ball and raceways draw a line which perpendicular to the bearing axis, where the load is transmitted from one raceway to another along the line. Angular contact ball bearings are available in few different configurations, i.e. single row, double row, and four point contact ball bearings.

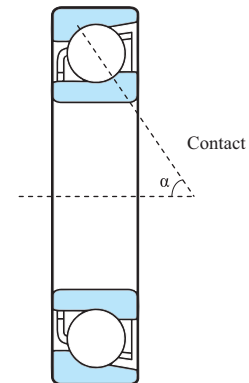

### Single Row Angular Contact Ball Bearing

Single row angular contact ball bearings are design to accommodate acting axial loads in one direction only. An acting force in axial direction will be produced when the bearing is under radial loads, and this axial acting force must be balanced by a counter force. Due to this, single row angular contact ball bearings are normally fitted or paired against another bearing. The most common contact angle is a  $40^\circ$ , others larger contact angle are available such as  $25^\circ$  and  $30^\circ$ .

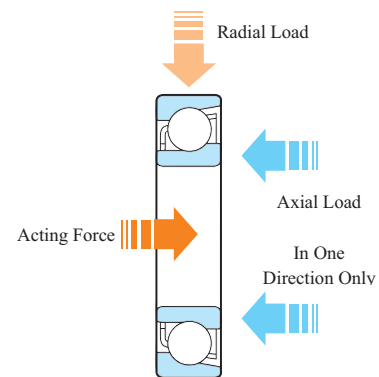

### Double Row Angular Contact Ball Bearings

Double row angular contact ball bearings are basically a combination or back to back mounting of 2 pieces of single row angular contact ball bearings. This combination of bearings, double row angular contact ball bearings can accommodate radial loads, and axial loads acting in both directions.

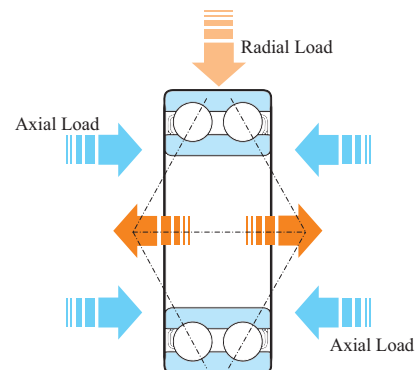

### Four Point Contact Ball Bearings

Four point contact ball bearings have their inner rings split in to 2 pieces with a contact angle of normally  $35^\circ$ . Its' split inner rings enable a large number of balls to be integrated in the bearing and creating higher load carrying capacity. This design has overcome the shortage of single row angular contact bearings; they support axial loads acting in both directions. Another advantage of four point contact ball bearings is it takes up considerably less axial space than double row angular contact ball bearings.

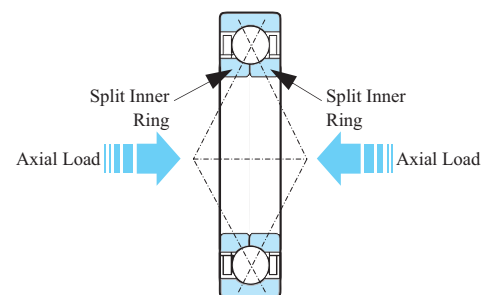

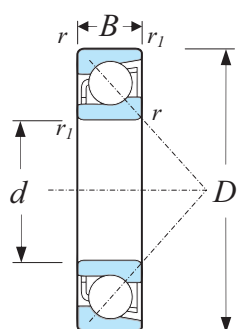

## ANGULAR CONTACT BALL BEARINGS Single Row

Table 17  
Bore Diameter 10mm - 25mm

Principal Dimension			Basic Load Ratings		Speed Ratings		Mass	Designations
d	D	B	Dynamic	Static	Ref. Speed	Limiting Speed		
mm			C	C <sub>0</sub>	r/min		kg	CT
10	30	9	7,02	3,35	30000	30000	0,03	7200 BT
12	32	10	7,61	3,8	26000	26000	0,036	7201 BT
12	37	12	10,6	5	24000	24000	0,063	7301 BT
15	35	11	8,84	4,8	24000	24000	0,045	7202 BT
15	42	13	13	6,7	20000	20000	0,081	7302 BT
17	40	12	11	5,85	22000	22000	0,07	7203 BM
17	40	12	11	5,85	22000	22000	0,064	7203 BT
17	40	12	11,1	6,1	20000	20000	0,064	7203 BM
17	47	14	15,9	8,3	19000	19000	0,11	7303 BT
20	47	14	13,3	7,65	18000	19000	0,11	7204 BM
20	47	14	14,3	8,15	19000	19000	0,11	7204 BT
20	47	14	14	8,3	18000	18000	0,11	7204 BW
20	52	15	19	10	18000	18000	0,15	7304 BM
20	52	15	19	10	18000	18000	0,14	7304 BT
20	52	15	19	10,4	16000	16000	0,15	7304 BW
20	52	15	19	10,4	16000	16000	0,15	7304 BM
25	52	15	15,6	10	17000	17000	0,14	7205 BM
25	52	15	15,6	10	17000	17000	0,13	7205 BT
25	52	15	15,6	10,2	15000	15000	0,13	7205 BW
25	62	17	26,5	15,3	15000	15000	0,24	7305 BM
25	62	17	26,5	15,3	15000	15000	0,23	7305 BT
25	62	17	26	15,6	14000	14000	0,24	7305 BW
25	80	21	39,7	23,6	11000	11000	0,61	7405 BM



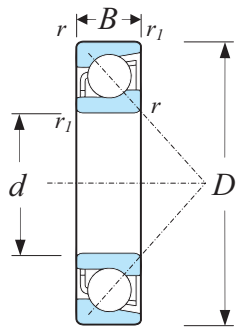

## ANGULAR CONTACT BALL BEARINGS

### Single Row

Table 18  
Bore Diameter 25mm - 40mm

Principal Dimension			Basic Load Ratings		Speed Ratings		Mass	Designations
d	D	B	Dynamic Static		Ref. Speed	Limiting Speed		
mm			C	C <sub>0</sub>	r/min		kg	CT
30	62	16	24	15,6	14000	14000	0,21	7206 BM
30	62	16	24	15,6	14000	14000	0,19	7206 BT
30	62	16	23,8	15,6	13000	13000	0,21	7206 BW
30	72	19	35,5	21,2	13000	13000	0,37	7306 BM
30	72	19	35,5	21,2	13000	13000	0,33	7306 BT
30	72	19	34,5	21,2	12000	12000	0,37	7306 BW
30	90	23	47,5	29	10000	10000	0,85	7406 BM
35	72	17	31	20,8	12000	12000	0,3	7207 BM
35	72	17	31	20,8	12000	12000	0,28	7207 BT
35	72	17	30,7	20,8	11000	11000	0,3	7207 BW
35	80	21	41,5	26,5	11000	11000	0,49	7307 BM
35	80	21	41,5	26,5	11000	11000	0,45	7307 BT
35	80	21	39	24,5	10000	10000	0,49	7307 BW
35	100	25	60,5	38	8500	9000	1,1	7407 BM
40	80	18	36,4	26	10000	10000	0,38	7208 BW
40	80	18	36,5	26	11000	11000	0,39	7208 BM
40	80	18	36,5	26	11000	11000	0,37	7208 BT

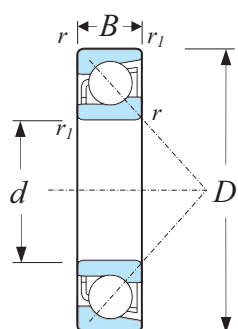

## ANGULAR CONTACT BALL BEARINGS

### Single Row

Table 19  
Bore Diameter 40mm - 50mm

Principal Dimension			Basic Load Ratings		Speed Ratings		Mass	Designations
d	D	B	Dynamic Static		Ref. Speed	Limiting Speed		
mm			C	C <sub>0</sub>	r/min		kg	CT
40	90	23	49,4	33,5	9000	9000	0,66	7308 BW
40	90	23	50	32,5	10000	10000	0,68	7308 BM
40	90	23	50	32,5	10000	10000	0,61	7308 BT
40	110	27	70,2	45	8000	8000	1,4	7408 BM
45	85	19	37,7	28	9000	9000	0,43	7209 BW
45	85	19	38	28,5	10000	10000	0,44	7209 BM
45	85	19	38	28,5	10000	10000	0,42	7209 BT
45	100	25	60,5	41,5	8000	8000	0,86	7309 BW
45	100	25	61	40,5	9000	9000	0,9	7309 BM
45	100	25	61	40,5	9000	9000	0,82	7309 BT
45	120	29	85,2	55	7000	7500	1,8	7409 BM
50	90	20	39	30,5	8500	8500	0,47	7210 BW
50	90	20	40	31	9000	9000	0,51	7210 BM
50	90	20	40	31	9000	9000	0,47	7210 BT
50	110	27	74,1	51	7500	7500	1,13	7310 BW
50	110	27	75	51	8000	8000	1,16	7310 BM
50	110	27	75	51	8000	8000	1,04	7310 BT

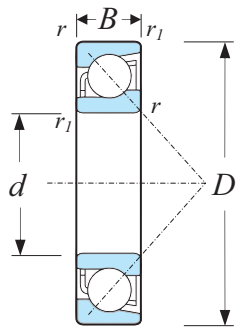

## ANGULAR CONTACT BALL BEARINGS

### Single Row

Table 20  
Bore Diameter 50mm - 60mm

Principal Dimension			Basic Load Ratings		Speed Ratings		Mass	Designations
d	D	B	Dynamic Static		Ref. Speed	Limiting Speed		
mm			C	C <sub>0</sub>	r/min		kg	CT
50	130	31	95,6	64	6300	6700	2,25	7410 BM
50	130	31	95,6	64	6300	6700	2,25	7410 BM
55	100	21	48,8	38	7500	7500	0,62	7211 BW
55	100	21	49	40	8000	8000	0,66	7211 BM
55	100	21	49	40	8000	8000	0,62	7211 BT
55	120	29	85,2	60	6700	6700	1,48	7311 BW
55	120	29	85	60	7000	7000	1,49	7311 BM
55	120	29	85	60	7000	7000	1,34	7311 BT
55	140	33	111	76,5	6000	6300	2,75	7411 BM
60	110	22	57,2	45,5	7000	7000	0,83	7212 BW
60	110	22	61	50	7500	7500	0,85	7212 BM
60	110	22	61	50	7500	7500	0,78	7212 BT
60	130	31	95,6	69,5	6000	6000	1,8	7312 BW
60	130	31	104	76,5	6700	6700	1,88	7312 BM
60	130	31	104	76,5	6700	6700	1,71	7312 BT

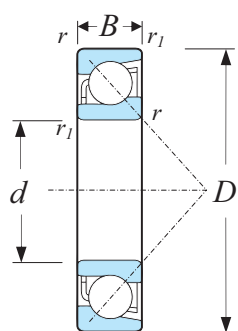

## ANGULAR CONTACT BALL BEARINGS Single Row

Table 21  
Bore Diameter 60mm - 70mm

Principal Dimension			Basic Load Ratings		Speed Ratings		Mass	Designations
d	D	B	Dynamic Static		Ref. Speed	Limiting Speed		
mm			C	C <sub>0</sub>	r/min		kg	CT
60	150	35	119	86,5	5600	5600	3,3	7412 BM
65	120	23	66,3	54	6300	6300	1	7213 BW
65	120	23	69,5	57	6700	6700	1,1	7213 BM
65	120	23	69,5	57	6700	6700	1	7213 BT
65	140	33	108	80	5600	5600	2,35	7313 BW
65	140	33	108	80	5600	5600	2,2	7313 BW
65	140	33	116	86,5	6300	6300	2,1	7313 BT
65	160	37	130	96,5	5000	5300	3,85	7413 BM
70	125	24	71,5	60	6000	6000	1,1	7214 BW
70	125	24	72	60	6300	6300	1,18	7214 BM
70	125	24	75	64	6300	6300	1,1	7214 BT
70	150	35	119	90	5300	5300	2,7	7314 BW
70	150	35	127	98	5600	5600	2,83	7314 BM
70	150	35	127	98	5600	5600	2,55	7314 BT

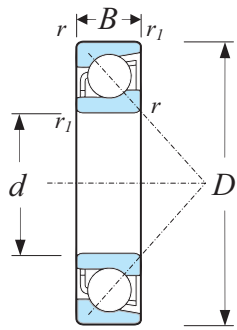

## ANGULAR CONTACT BALL BEARINGS

### Single Row

Table 22  
Bore Diameter 70mm - 85mm

Principal Dimension			Basic Load Ratings		Speed Ratings		Mass	Designations
d	D	B	Dynamic	Static	Ref. Speed	Limiting Speed		
mm			C	C <sub>0</sub>	r/min		kg	CT
70	180	42	159	127	4500	4800	5	7414 BM
75	130	25	72,8	64	5600	5600	1,26	7215 BW
75	130	25	73,5	65,5	6300	6300	1,29	7215 BM
75	130	25	73,5	65,5	6300	6300	1,18	7215 BT
75	160	37	133	106	5000	5000	3,2	7315 BW
75	160	37	132	104	5300	5300	3,26	7315 BM
75	160	37	132	104	5300	5300	3,06	7315 BT
75	190	45	168	140	4300	4500	6,85	7415 BM
80	140	26	83,2	73,5	5300	5300	1,58	7216 BW
80	140	26	85	75	5600	5600	1,59	7216 BM
80	140	26	85	75	5600	5600	1,43	7216 BT
80	170	39	143	118	4500	4500	3,85	7316 BW
80	170	39	143	118	5000	5000	4,03	7316 BM
80	170	39	143	118	5000	5000	3,64	7316 BT
80	200	48	178	153	4000	4300	8	7416 BM
85	150	28	95,6	83	5000	5000	1,9	7217 BW
85	150	28	95,6	83	5000	5300	1,99	7217 BM

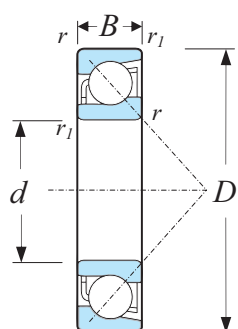

## ANGULAR CONTACT BALL BEARINGS Single Row

Table 23  
Bore Diameter 85mm - 95mm

Principal Dimension			Basic Load Ratings		Speed Ratings		Mass	Designations
d	D	B	Dynamic Static		Ref. Speed	Limiting Speed		
mm			C	C <sub>0</sub>	r/min		kg	CT
85	150	28	102	90	5300	5300	1,83	7217 BT
85	180	41	146	122	4300	4300	4,75	7317 BW
85	180	41	156	132	4800	4800	4,74	7317 BM
85	180	41	156	132	4800	4800	4,26	7317 BT
90	160	30	108	96,5	4500	4500	2,34	7218 BW
90	160	30	108	96,5	4500	4800	2,41	7218 BM
90	160	30	116	104	4800	4800	2,12	7218 BT
90	190	43	165	146	4000	4000	5,22	7318 BW
90	190	43	166	146	4500	4500	5,53	7318 BM
90	190	43	166	146	4500	4500	4,98	7318 BT
90	225	54	216	200	3600	3800	11,5	7418 BM
95	170	32	129	118	4800	4800	2,95	7219 BM
95	170	32	129	118	4800	4800	2,68	7219 BT
95	170	32	124	108	4300	4300	2,82	7219 BW
95	200	45	180	163	4300	4300	6,41	7319 BM
95	200	45	180	163	4300	4300	5,77	7319 BT
95	200	45	178	163	3800	3800	6,17	7319 BW

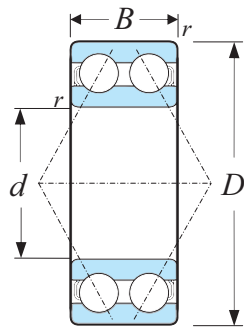

## ANGULAR CONTACT BALL BEARINGS

### Double Row

Table 24  
Bore Diameter 10mm - 25mm

Principal Dimension			Basic Load Ratings		Speed Ratings		Mass	Designations
d	D	B	Dynamic Static		Ref. Speed	Limiting Speed		
mm			C	C <sub>0</sub>	r/min		kg	CT
10	30	14	7,61	4,3	-	17000	0,051	3200 2RS
10	30	14	7,61	4,3	22000	24000	0,051	3200 2Z
10	30	14	7,61	4,3	22000	24000	0,051	3200 B
10	30	14,3	7,61	4,3	-	17000	0,051	5200 2RS
10	30	14,3	7,61	4,3	22000	24000	0,051	5200 2Z
10	30	14,3	7,61	4,3	22000	24000	0,051	5200 B
12	32	15,9	10,1	5,6	-	15000	0,058	3201 2RS
12	32	15,9	10,1	5,6	20000	22000	0,058	3201 2Z
12	32	15,9	10,1	5,6	20000	22000	0,058	3201 B
12	32	15,9	10,1	5,6	-	15000	0,058	5201 2RS
12	32	15,9	10,1	5,6	20000	22000	0,058	5201 2Z
12	32	15,9	10,1	5,6	20000	22000	0,058	5201 B
15	35	15,9	11,2	6,8	-	14000	0,066	3202 2RS
15	35	15,9	11,2	6,8	17000	18000	0,066	3202 2Z
15	35	15,9	11,2	6,8	17000	18000	0,066	3202 B
15	35	15,9	11,2	6,8	-	14000	0,066	5202 2RS
15	35	15,9	11,2	6,8	17000	18000	0,066	5202 2Z
15	35	15,9	11,2	6,8	17000	18000	0,066	5202 B
15	42	19	15,1	9,3	-	12000	0,13	3302 2RS
15	42	19	15,1	9,3	15000	16000	0,13	3302 2Z
15	42	19	15,1	9,3	15000	16000	0,13	3302 B
17	40	17,5	14,3	8,8	-	12000	0,096	3203 2RS
17	40	17,5	14,3	8,8	15000	16000	0,1	3203 2Z
17	40	17,5	14,3	8,8	15000	16000	0,095	3203 B
17	40	17,5	14,3	8,8	-	12000	0,096	5203 2RS
17	40	17,5	14,3	8,8	15000	16000	0,1	5203 2Z
17	40	17,5	14,3	8,8	15000	16000	0,095	5203 B
17	47	22,2	21,6	12,7	-	11000	0,18	3303 2RS
17	47	22,2	21,6	12,7	14000	14000	0,18	3303 2Z
17	47	22,2	21,6	12,7	14000	14000	0,18	3303 B
20	47	20,6	20	12	14000	14000	0,16	3204
20	47	20,6	20	12	-	10000	0,14	3204 2RS
20	47	20,6	20	12	14000	14000	0,16	3204 2Z
20	47	20,6	20	12	14000	14000	0,15	3204 B
20	47	20,6	20	12	14000	14000	0,16	5204
20	47	20,6	20	12	-	10000	0,14	5204 2RS
20	47	20,6	20	12	14000	14000	0,15	5204 2Z
20	52	22,2	23,6	14,6	13000	13000	0,2	3304
20	52	22,2	23,6	14,6	-	9000	0,21	3304 2RS
20	52	22,2	23,6	14,6	13000	13000	0,22	3304 2Z
20	52	22,2	23,6	14,6	13000	13000	0,22	3304 B
20	52	22,2	23,6	14,6	13000	13000	0,2	5304
20	52	22,2	23,6	14,6	-	9000	0,21	5304 2RS
20	52	22,2	23,6	14,6	13000	13000	0,21	5304 2Z
25	52	20,6	21,6	14,3	12000	12000	0,19	3205
25	52	20,6	21,6	14,3	-	8500	0,18	3205 2RS

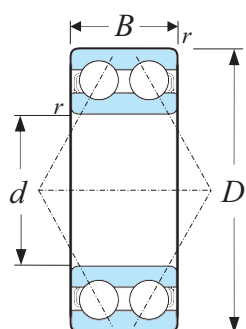

## ANGULAR CONTACT BALL BEARINGS

### Double Row

Table 25  
Bore Diameter 25mm - 35mm

Principal Dimension			Basic Load Ratings		Speed Ratings		Mass	Designations
d	D	B	Dynamic	Static	Ref. Speed	Limiting Speed		
mm			C	C <sub>0</sub>	r/min		kg	CT
25	52	20,6	21,6	14,3	12000	12000	0,18	3205 2Z
25	52	20,6	21,6	14,3	12000	12000	0,18	3205 B
25	52	20,6	21,6	14,3	12000	12000	0,19	5205
25	52	20,6	21,6	14,3	-	8500	0,18	5205 2RS
25	52	20,6	21,6	14,3	12000	12000	0,18	5205 2Z
25	52	20,6	22,9	21,2	11000	12000	0,25	5205
25	62	25,4	32	20,4	11000	11000	0,31	3305
25	62	25,4	32	20,4	-	7500	0,35	3305 2RS
25	62	25,4	32	20,4	11000	11000	0,35	3305 2Z
25	62	25,4	32	20,4	11000	11000	0,35	3305 B
25	62	25,4	32	20,4	11000	11000	0,31	5305
25	62	25,4	32	20,4	-	7500	0,35	5305 2RS
25	62	25,4	32	20,4	11000	11000	0,35	5305 2Z
30	62	23,8	30	20,4	10000	10000	0,29	3206
30	62	23,8	30	20,4	-	7500	0,27	3206 2RS
30	62	23,8	30	20,4	10000	10000	0,29	3206 2Z
30	62	23,8	30	20,4	10000	10000	0,29	3206 B
30	62	23,8	30	20,4	10000	10000	0,29	5206
30	62	23,8	30	20,4	-	7500	0,27	5206 2RS
30	62	23,8	30	20,4	10000	10000	0,27	5206 2Z
30	62	23,8	30,3	28	9500	10000	0,35	5206
30	62	23,8	30,3	28	-	7500	0,35	5206 2RS
30	62	23,8	30,3	28	9500	10000	0,35	5206 2Z
30	72	30,2	41,5	27,5	9000	9000	0,59	3306
30	72	30,2	41,5	27,5	-	6300	0,52	3306 2RS
30	72	30,2	41,5	27,5	9000	9000	0,52	3306 2Z
30	72	30,2	41,5	27,5	9000	9000	0,53	3306 B
30	72	30,2	41,5	27,5	9000	9000	0,59	5306
30	72	30,2	41,5	27,5	-	6300	0,53	5306 2RS
30	72	30,2	41,5	27,5	9000	9000	0,52	5306 2Z
35	72	27	40	28	9000	9000	0,4	3207
35	72	27	40	28	-	6300	0,44	3207 2RS
35	72	27	40	28	9000	9000	0,44	3207 2Z
35	72	27	40	28	9000	9000	0,44	3207 B



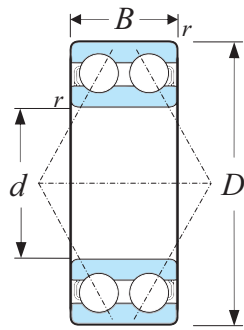

## ANGULAR CONTACT BALL BEARINGS

### Double Row

Table 26  
Bore Diameter 35mm - 45mm

Principal Dimension			Basic Load Ratings		Speed Ratings		Mass	Designations
d	D	B	Dynamic Static		Ref. Speed	Limiting Speed		
mm			C	C <sub>0</sub>	r/min		kg	CT
35	72	27	40	28	9000	9000	0,4	5207
35	72	27	40	28	-	6300	0,44	5207 2RS
35	72	27	40	28	9000	9000	0,44	5207 2Z
35	80	34,9	52	35,5	8500	8500	0,71	3307
35	80	34,9	52	35,5	-	6000	0,73	3307 2RS
35	80	34,9	52	35,5	8500	8500	0,73	3307 2Z
35	80	34,9	52	35,5	8500	8500	0,71	3307 B
35	80	34,9	52	35,5	8500	8500	0,71	5307
35	80	34,9	52	35,5	-	6000	0,73	5307 2RS
35	80	34,9	52	35,5	8500	8500	0,73	5307 2Z
40	80	30,2	47,5	34	8000	8000	0,58	3208
40	80	30,2	47,5	34	-	5600	0,57	3208 2RS
40	80	30,2	47,5	34	8000	8000	0,57	3208 2Z
40	80	30,2	47,5	34	8000	8000	0,58	3208 B
40	80	30,2	47,5	34	8000	8000	0,58	5208
40	80	30,2	47,5	34	-	5600	0,57	5208 2RS
40	80	30,2	47,5	34	8000	8000	0,57	5208 2Z
40	90	36,5	64	44	7500	7500	1,05	3308
40	90	36,5	64	44	-	5000	0,93	3308 2RS
40	90	36,5	64	44	7500	7500	0,93	3308 2Z
40	90	36,5	64	44	7500	7500	1,05	3308 B
40	90	36,5	68,9	64	6700	7000	1,05	3308
40	90	36,5	64	44	7500	7500	1,05	5308
40	90	36,5	64	44	-	5000	0,93	5308 2RS
40	90	36,5	64	44	7500	7500	0,93	5308 2Z
40	110	49,2	88,4	60	5600	6000	2,3	5408
45	85	30,2	51	39	7500	7500	0,64	3209
45	85	30,2	51	39	-	5300	0,63	3209 2RS
45	85	30,2	51	39	7500	7500	0,63	3209 2Z

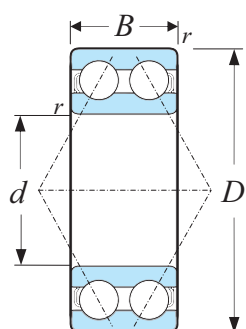

## ANGULAR CONTACT BALL BEARINGS

### Double Row

Table 27  
Bore Diameter 45mm - 55mm

Principal Dimension			Basic Load Ratings		Speed Ratings		Mass	Designations
d	D	B	Dynamic Static		Ref. Speed	Limiting Speed		
mm			C	C <sub>0</sub>	r/min		kg	CT
45	85	30,2	51	39	7500	7500	0,63	3209 B
45	85	30,2	51	39	7500	7500	0,64	5209
45	85	30,2	51	39	-	5300	0,63	5209 2RS
45	85	30,2	51	39	7500	7500	0,63	5209 2Z
45	100	39,7	75	53	6700	6700	1,4	3309
45	100	39,7	75	53	-	4800	1,4	3309 2RS
45	100	39,7	75	53	6700	6700	1,4	3309 2Z
45	100	39,7	75	53	6700	6700	1,4	3309 B
45	100	39,7	75	53	-	4800	1,4	5309 2RS
45	100	39,7	75	53	6700	6700	1,4	5309 2Z
45	100	39,7	80,9	80	6000	6300	1,5	5309
45	120	54	112	82	5300	5600	3	5409
50	90	30,2	51	39	7000	7000	0,66	3210
50	90	30,2	51	39	-	4800	0,65	3210 2RS
50	90	30,2	51	39	7000	7000	0,65	3210 2Z
50	90	30,2	51	39	7000	7000	0,66	3210 B
50	90	30,2	51	39	7000	7000	0,66	5210
50	90	30,2	51	39	-	4800	0,65	5210 2RS
50	90	30,2	51	39	7000	7000	0,65	5210 2Z
50	110	44,4	90	64	6000	6000	1,95	3310
50	110	44,4	90	64	-	4300	1,95	3310 2RS
50	110	44,4	90	64	6000	6000	1,95	3310 2Z
50	110	44,4	90	64	6000	6000	1,95	3310 B
50	110	44,4	90	64	-	4300	1,95	5310 2RS
50	110	44,4	90	64	6000	6000	1,95	5310 2Z
50	110	44,4	95,2	95	5300	5600	2	5310
50	130	58,7	143	104	4800	5000	3,7	5410
55	100	33,3	60	47,5	6300	6300	1,05	3211
55	100	33,3	60	47,5	-	4500	1,05	3211 2RS
55	100	33,3	60	47,5	6300	6300	1,05	3211 2Z
55	100	33,3	60	47,5	6300	6300	1,05	3211 B
55	100	33,3	60	47,5	6300	6300	1,05	5211
55	100	33,3	60	47,5	-	4500	1,05	5211 2RS
55	100	33,3	60	47,5	6300	6300	1,05	5211 2Z

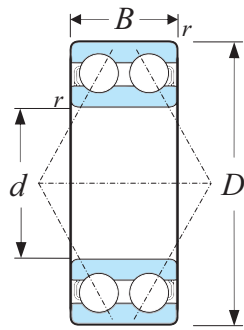

## ANGULAR CONTACT BALL BEARINGS

### Double Row

Table 28  
Bore Diameter 55mm - 70mm

Principal Dimension			Basic Load Ratings		Speed Ratings		Mass	Designations
d	D	B	Dynamic Static		Ref. Speed	Limiting Speed		
mm			C	C <sub>0</sub>	r/min		kg	CT
55	120	49,2	112	81,5	5300	5300	2,55	3311
55	120	49,2	112	81,5	-	3800	2,55	3311 2RS
55	120	49,2	112	81,5	5300	5300	2,55	3311 2Z
55	120	49,2	112	81,5	5300	5300	2,55	3311 B
55	120	49,2	119	122	5000	5300	2,65	5311
55	120	49,2	119	122	5000	5300	2,65	5311 2Z
55	140	63,5	146	108	4300	4500	4,7	5411
60	110	36,5	73,5	58,5	5600	5600	1,4	3212
60	110	36,5	73,5	58,5	-	4000	1,4	3212 2RS
60	110	36,5	73,5	58,5	5600	5600	1,4	3212 2Z
60	110	36,5	73,5	58,5	5600	5600	1,4	3212 B
60	110	36,5	73,5	58,5	5600	5600	1,4	5212
60	110	36,5	73,5	58,5	-	4000	1,4	5212 2RS
60	110	36,5	73,5	58,5	5600	5600	1,4	5212 2Z
60	130	54	127	95	5000	5000	3,25	3312
60	130	54	127	95	5000	5000	3,25	3312 2Z
60	130	54	127	95	5000	5000	3,25	5312
60	130	54	127	95	5000	5000	3,25	5312 2Z
60	150	66,7	159	122	4000	4300	5,7	5412
65	120	38,1	80,6	73,5	4500	4800	1,75	3213
65	120	38,1	80,6	73,5	-	3600	1,75	3213 2RS
65	120	38,1	80,6	73,5	4500	4800	1,75	3213 2Z
65	120	38,1	80,6	73,5	4500	4800	1,75	5213
65	120	38,1	80,6	73,5	-	3600	1,75	5213 2RS
65	120	38,1	80,6	73,5	4500	4800	1,75	5213 2Z
65	140	58,7	146	110	4500	4500	4,1	3313
65	140	58,7	146	110	4500	4500	4,1	3313 2Z
65	140	58,7	138	122	4300	4500	4	3313
65	140	58,7	146	110	4500	4500	4,1	5313
65	140	58,7	146	110	4500	4500	4,1	5313 2Z
65	160	71,4	195	163	3800	4000	6,75	5413
70	125	39,7	88,4	80	4300	4500	1,9	3214
70	125	39,7	88,4	80	4300	4500	1,9	3214 2Z
70	125	39,7	88,4	80	4300	4500	1,9	5214
70	125	39,7	88,4	80	4300	4500	1,9	5214 2Z

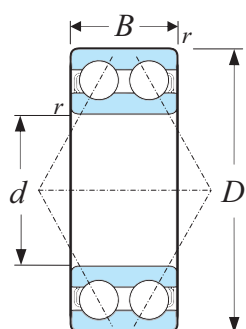

## ANGULAR CONTACT BALL BEARINGS

### Double Row

Table 29  
Bore Diameter 70mm - 110mm

Principal Dimension			Basic Load Ratings		Speed Ratings		Mass	Designations
d	D	B	Dynamic Static		Ref. Speed	Limiting Speed		
mm			C	C <sub>0</sub>	r/min		kg	CT
70	150	63,5	163	125	4300	4300	5,05	3314
70	150	63,5	163	125	4300	4300	5,05	3314 2Z
70	150	63,5	163	125	4300	4300	5,05	5314
70	150	63,5	163	125	4300	4300	5,05	5314 2Z
70	150	63,5	172	186	4000	4300	5	5314
70	180	79,4	199	170	3400	3600	9,9	5414
75	130	41,3	95,6	88	4300	4500	2,1	3215
75	130	41,3	95,6	88	4300	4500	2,1	3215 2Z
75	130	41,3	95,6	88	4300	4500	2,1	5215
75	130	41,3	95,6	88	-	3200	2,1	5215 2RS
75	130	41,3	95,6	88	4300	4500	2,1	5215 2Z
75	130	41,3	108	137	4300	4500	2,5	5215 2Z
75	160	68,3	176	140	4000	4000	5,55	3315
75	160	68,3	176	140	4000	4000	5,6	3315 2Z
75	160	68,3	187	208	3600	3800	6,35	5315
80	140	44,4	106	95	4000	4300	2,65	3216
80	140	44,4	106	95	4000	4300	2,65	5216
80	140	44,4	106	95	-	3000	2,65	5216 2RS
80	140	44,4	128	160	4000	4000	3	5216 2Z
80	170	68,3	182	156	3400	3600	6,8	3316
80	170	68,3	190	196	3400	3600	7,55	3316 M
80	170	68,3	182	156	3400	3600	6,8	5316
85	150	49,2	124	110	3600	3800	3,4	3217
85	150	49,2	124	110	3600	3800	3,4	5217
85	150	49,2	124	110	3600	3800	3,4	5217 2Z
85	180	73	195	176	3200	3400	8,3	3317
85	180	73	195	176	3200	3400	8,3	5317
90	160	52,4	130	120	3400	3600	4,15	3218
90	160	52,4	130	120	3400	3600	4,15	5218 2Z
90	160	52,4	151	193	3400	3600	4,55	5218
90	190	73	195	180	3000	3200	9,25	3318
90	190	73	225	250	3000	3200	10	3318 M
90	190	73	195	180	3000	3200	9,25	5318
95	170	55,6	159	146	3200	3400	5	3219
95	170	55,6	159	146	3200	3400	5	5219
95	200	77,8	225	216	2800	3000	11	3319
95	200	77,8	242	275	2800	3000	12	3319 M
100	180	60,3	178	166	3000	3200	6,1	3220
100	180	60,3	178	166	3000	3200	6,1	5220
100	215	82,6	255	255	2600	2800	13,5	3320
100	215	82,6	260	305	2600	2800	15	3320 M
110	200	69,8	212	212	2800	2800	8,8	3222
110	200	69,8	212	212	2800	2800	8,8	5222
110	240	92,1	291	305	2400	2600	19	3322
110	240	92,1	307	375	2400	2600	21	3322 M

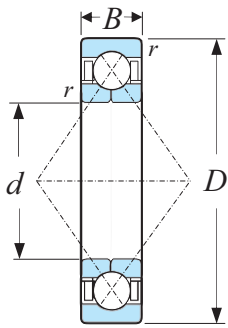

## ANGULAR CONTACT BALL BEARINGS

### Four Point Contact Bearings

Table 30  
Bore Diameter 15mm - 75mm

Principal Dimension			Basic Load Ratings		Speed Ratings		Mass	Designations
d	D	B	Dynamic Static		Ref. Speed	Limiting Speed		
mm			C	C <sub>0</sub>	r/min		kg	CT
15	35	11	12,7	8,3	22000	36000	0,062	QJ202 M
17	40	12	15,9	10,6	19000	30000	0,082	QJ203 M
17	47	14	23,4	15	17000	28000	0,14	QJ303 M
20	52	15	32	21,6	18000	24000	0,18	QJ304 M
20	52	15	32	21,6	18000	24000	0,18	QJ304 M
20	52	15	32	21,6	20000	24000	0,16	QJ304 T
25	52	15	27	21,2	16000	22000	0,16	QJ205 M
25	52	15	27	21,2	16000	22000	0,16	QJ205 M
25	62	17	39	28	12000	20000	0,29	QJ305 M
25	62	17	39	28	12000	20000	0,29	QJ305 M
30	62	16	37,5	30,5	14000	19000	0,24	QJ206 M
30	62	16	37,5	30,5	14000	19000	0,24	QJ206 M
30	72	19	53	41,5	12000	17000	0,42	QJ306 M
30	72	19	53	41,5	12000	17000	0,42	QJ306 M
30	72	19	53	41,5	14000	17000	0,37	QJ306 T
35	72	17	49	41,5	12000	17000	0,36	QJ207 M
35	80	21	64	51	11000	15000	0,57	QJ307 M
35	80	21	64	51	11000	15000	0,57	QJ307 M
35	80	21	64	51	13000	15000	0,48	QJ307 T
40	80	18	56	49	11000	15000	0,45	QJ208 M
40	80	18	56	49	11000	15000	0,45	QJ208 M
40	90	23	78	64	10000	14000	0,78	QJ308 M
40	90	23	78	64	10000	14000	0,78	QJ308 M
45	85	19	63	56	10000	14000	0,52	QJ209 M
45	100	25	100	83	9000	12000	1,05	QJ309 M
45	100	25	100	83	9000	12000	1,05	QJ309 M
45	100	25	100	83	10000	12000	0,9	QJ309 T
50	90	20	65,5	61	9000	13000	0,59	QJ210 M
50	110	27	118	100	8000	11000	1,35	QJ310 M
50	110	27	118	100	9000	11000	1,35	QJ310 T
55	100	21	85	83	8000	11000	0,77	QJ211 M
55	100	21	85	83	8000	11000	0,77	QJ211 M
55	120	29	137	118	7000	10000	1,75	QJ311 M
55	120	29	137	118	7000	10000	1,75	QJ311 M
60	110	22	96,5	93	7500	10000	0,99	QJ212 M
60	110	22	96,5	93	7500	10000	0,99	QJ212 M
60	110	22	96,5	93	8500	10000	0,89	QJ212 T
60	130	31	156	137	6700	9000	2,15	QJ312 M
60	130	31	156	137	6700	9000	2,15	QJ312 M
65	120	23	110	112	6700	9500	1,2	QJ213 M
65	120	23	110	112	6700	9500	1,2	QJ213 M
65	140	33	176	156	6300	8500	2,7	QJ313 M
70	125	24	120	122	6300	9000	1,3	QJ214 M
70	125	24	120	122	6300	9000	1,3	QJ214 M
70	125	24	120	122	7500	9000	1,19	QJ214 T
70	150	35	200	180	5600	8000	3,15	QJ314 M
70	150	35	200	180	5600	8000	3,15	QJ314 M
70	150	35	200	180	6700	8000	2,78	QJ314 T
75	130	25	125	132	6300	8500	1,45	QJ215 M
75	130	25	125	132	6300	8500	1,45	QJ215 M

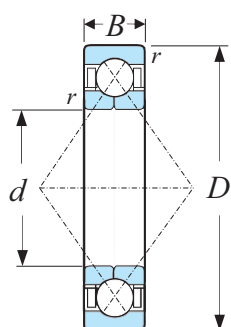

## ANGULAR CONTACT BALL BEARINGS

### Four Point Contact Bearings

Table 31  
Bore Diameter 75mm - 200mm

Principal Dimension			Basic Load Ratings		Speed Ratings		Mass	Designations
d	D	B	Dynamic	Static	Ref. Speed	Limiting Speed		
mm			C	C <sub>0</sub>	r/min		kg	CT
75	130	25	125	132	7000	8500	1,27	QJ215 T
75	160	37	216	200	5300	7500	3,9	QJ315 M
80	140	26	146	156	5600	8000	1,85	QJ216 M
80	140	26	146	156	5600	8000	1,85	QJ216 M
80	170	39	232	228	5000	7000	4,6	QJ316 M
85	130	22	85,2	102	5000	8000	1,1	QJ1017 M
85	150	28	156	173	5300	7500	2,25	QJ217 M
85	150	28	156	173	5300	7500	2,25	QJ217 M
85	180	41	250	255	4800	6700	5,45	QJ317 M
90	160	30	186	200	5000	7000	2,75	QJ218 M
90	190	43	285	305	4500	6300	6,45	QJ318 M
95	170	32	212	232	4800	6700	3,35	QJ219 M
95	200	45	305	340	4300	6000	7,45	QJ319 M
100	180	34	236	265	4500	6300	4,05	QJ220 M
100	215	47	345	400	4000	5600	9,3	QJ320 M
105	160	26	124	156	4000	6700	2	QJ1021 M
110	170	28	146	186	3800	6300	2,5	QJ1022 M
110	200	38	280	325	4000	5600	5,6	QJ222 M
110	240	50	390	480	3600	4800	12,5	QJ322 M
120	215	40	300	365	3600	5000	6,95	QJ224 M
120	260	55	415	530	3200	4500	16	QJ324 M
130	230	40	310	400	3400	4800	7,75	QJ226 M
130	280	58	455	610	3000	4000	19,5	QJ326 M
140	250	42	345	475	3200	4300	9,85	QJ228 M
140	300	62	500	695	2800	3800	24	QJ328 M
150	225	35	216	305	2800	4500	5,25	QJ1030 M
150	270	45	400	570	3000	4000	12,5	QJ230 M
150	320	65	530	765	2600	3600	29	QJ330 M
160	240	38	247	355	2600	4300	6,45	QJ1032 M
160	290	48	450	670	2800	3800	15,5	QJ232 M
160	340	68	570	880	2400	3400	34,5	QJ332 M
170	310	52	455	720	2600	3400	19,5	QJ234 M
170	360	72	655	1040	2200	3200	41,5	QJ334 M
180	320	52	475	765	2400	3400	20,5	QJ236 M
180	380	75	680	1020	2200	3000	47,5	QJ336 M
190	290	46	338	510	2200	3400	11,5	QJ1038 M
190	340	55	488	780	1900	3200	23,3	QJ238 M
190	400	78	702	1160	1700	2800	49	QJ338 M
200	310	51	390	620	2000	3200	15	QJ1040 M
200	360	58	540	915	1800	3000	28,5	QJ240 M
200	360	70	520	865	1800	3000	32,5	QJ1240 M

### SELF-ALIGNING BALL BEARINGS

The outer ring of self-aligning ball bearing has s sphere raceways, the balls and the cage are allowed to have certain angle of deflect around the bearing center. This enabled the bearings to have self-aligning capability, and insensitive to misalignment of mounting shaft. Self-aligning ball bearings are mostly suitable for application where there is expected deflection or misalignment of shaft. Among all rolling bearings, self-aligning ball bearing has the lowest friction factor, which enables it to run cooler even at high speeds. However, self-aligning ball bearings do not accommodate any axial loads.

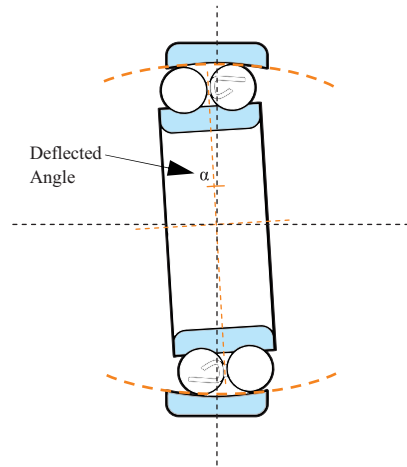
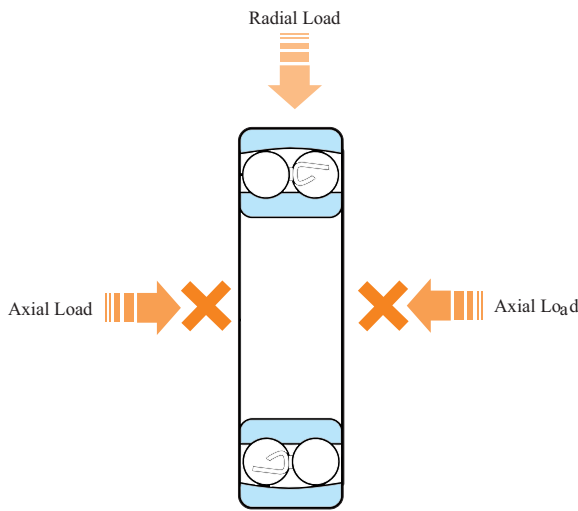
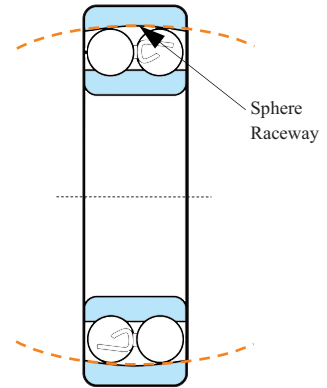

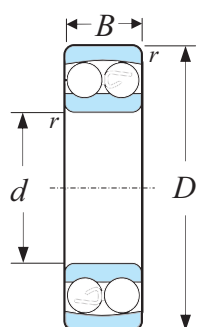

## SELF-ALIGNING BALL BEARINGS

Cylindrical & Tapered Bore

Table 32  
Bore Diameter 10mm - 30mm

Principal Dimension			Basic Load Ratings		Speed Ratings		Mass	Designations
d	D	B	Dynamic Static		Ref. Speed	Limiting Speed		
mm			C	C <sub>0</sub>	r/min		kg	CT
10	30	9	5,53	1,18	56000	36000	0,034	1200 TN
10	30	14	5,53	1,18	-	17000	0,048	2200 2RSTN
10	30	14	8,06	1,73	50000	34000	0,047	2200 TN
12	32	10	6,24	1,43	50000	32000	0,04	1201 TN
12	32	14	6,24	1,43	-	16000	0,053	2201 2RSTN
12	32	14	8,52	1,9	45000	30000	0,053	2201 TN
12	37	12	9,36	2,16	40000	28000	0,072	1301 M
12	37	12	9,36	2,16	40000	28000	0,067	1301 TN
12	37	17	11,7	2,7	38000	28000	0,095	2301
15	35	11	7,41	1,76	45000	28000	0,049	1202 TN
15	35	14	7,41	1,76	-	14000	0,058	2202 2RSTN
15	35	14	8,71	2,04	38000	26000	0,06	2202 TN
15	42	13	10,8	2,6	34000	24000	0,094	1302 TN
15	42	17	11,9	2,9	32000	24000	0,12	2302
15	42	17	10,8	2,6	-	12000	0,11	2302 2RSTN
17	40	12	8,84	2,2	38000	24000	0,073	1203 TN
17	40	16	8,84	2,2	-	12000	0,089	2203 2RSTN
17	40	16	10,6	2,55	34000	24000	0,088	2203 TN
17	47	14	12,7	3,4	28000	20000	0,13	1303 M
17	47	14	12,7	3,4	28000	20000	0,12	1303 TN
17	47	19	14,6	3,55	30000	22000	0,16	2303
17	47	19	12,7	3,4	-	11000	0,16	2303 2RSTN
17	47	19	14,6	3,55	30000	22000	0,18	2303 M
20	47	14	12,7	3,4	32000	20000	0,12	1204 TN
20	47	14	12,7	3,4	32000	20000	0,12	1204 TN
20	47	18	12,7	3,4	-	10000	0,14	2204 2RSTN
20	47	18	16,8	4,15	28000	20000	0,14	2204 TN
20	47	40	12,7	3,4	-	9000	0,18	11204 TN
20	52	15	14,3	4	26000	18000	0,16	1304 TN
20	52	21	14,3	4	-	9000	0,21	2304 2RSTN
20	52	21	18,2	4,75	26000	19000	0,23	2304 M
20	52	21	18,2	4,75	26000	19000	0,22	2304 TN
25	52	15	14,3	4	28000	18000	0,14	1205 TN
25	52	18	14,3	4	-	9000	0,16	2205 2RSTN
25	52	18	16,8	4,4	26000	18000	0,16	2205 TN
25	52	44	14,3	4	-	8000	0,22	11205 TN
25	62	17	19	5,4	22000	15000	0,26	1305 TN
25	62	24	19	5,4	-	7500	0,34	2305 2RSTN
25	62	24	27	7,1	22000	16000	0,34	2305 TN
25	62	24	24,2	6,55	22000	16000	0,36	2305 M
30	62	16	15,6	4,65	24000	15000	0,22	1206 TN
30	62	16	15,6	4,65	24000	15000	0,24	1206 M
30	62	16	15,6	4,65	24000	15000	0,22	1206 TN
30	62	20	15,6	4,65	-	7500	0,26	2206 2RSTN



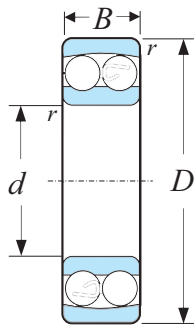

## SELF-ALIGNING BALL BEARINGS

### Cylindrical & Tapered Bore

Table 33  
Bore Diameter 30mm - 50mm

Principal Dimension			Basic Load Ratings		Speed Ratings		Mass	Designations
d	D	B	Dynamic	Static	Ref. Speed	Limiting Speed		
mm			C	C <sub>0</sub>	r/min		kg	Local
30	62	20	23,8	6,7	22000	15000	0,26	2206 TN
30	72	19	22,5	6,8	19000	13000	0,39	1306 TN
30	72	27	31,2	8,8	18000	13000	0,5	2306
30	72	27	22,5	6,8	-	6700	0,51	2306 2RSTN
30	72	27	31,2	8,8	18000	13000	0,5	2306 K
30	72	27	31,2	8,8	18000	13000	0,55	2306 M
35	72	17	19	6	20000	13000	0,32	1207 TN
35	72	23	19	6	-	6300	0,41	2207 2RSTN
35	72	23	30,7	8,8	18000	12000	0,4	2207 TN
35	80	21	26,5	8,5	16000	11000	0,51	1307 TN
35	80	31	26,5	8,5	-	5600	0,7	2307 2RSTN
35	80	31	39,7	11,2	16000	12000	0,68	2307 TN
35	80	31	39,7	11,2	16000	12000	0,75	2307 M
35	80	31	39,7	11,2	16000	12000	0,68	2307 TN
35	80	31	39,7	11,2	16000	12000	0,75	2307 EKTN
40	80	18	19,9	6,95	18000	11000	0,42	1208 TN
40	80	23	19,9	6,95	-	5600	0,5	2208 2RSTN
40	80	23	31,9	10	16000	11000	0,51	2208 TN
40	90	23	33,8	11,2	14000	9500	0,68	1308 TN
40	90	23	33,8	11,2	14000	9500	0,72	1308 M
40	90	23	33,8	11,2	14000	9500	0,68	1308 TN
40	90	33	33,8	11,2	-	5000	0,96	2308 2RSTN
40	90	33	54	16	14000	10000	0,9	2308 TN
40	90	33	54	16	14000	10000	0,99	2308 M
45	85	19	22,9	7,8	17000	11000	0,47	1209 TN
45	85	23	22,9	7,8	-	5300	0,53	2209 2RSTN
45	85	23	32,5	10,6	15000	10000	0,55	2209 TN
45	100	25	39	13,4	12000	8500	0,96	1309 TN
45	100	25	39	13,4	12000	8500	0,96	1309 TN
45	100	36	39	13,4	-	4500	1,3	2309 2RSTN
45	100	36	63,7	19,3	13000	9000	1,15	2309 TN
45	100	36	63,7	19,3	13000	9000	1,3	2309 M
45	100	36	63,7	19,3	13000	9000	1,25	2309 TN
50	90	20	26,5	9,15	16000	10000	0,53	1210 TN
50	90	23	22,9	8,15	-	4800	0,57	2210 2RSTN
50	90	23	33,8	11,2	14000	9500	0,6	2210 TN

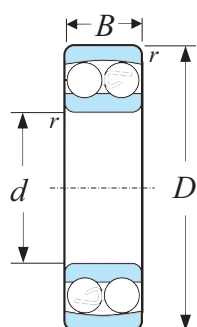

## SELF-ALIGNING BALL BEARINGS

### Cylindrical & Tapered Bore

Table 34  
Bore Diameter 50mm - 75mm

Principal Dimension			Basic Load Ratings		Speed Ratings		Mass	Designations
d	D	B	Dynamic	Static	Ref. Speed	Limiting Speed		
mm			C	C <sub>0</sub>	r/min		kg	Local
50	90	23	33,8	11,2	14000	9500	0,6	2210 TN
50	110	27	43,6	14	12000	8000	1,2	1310 TN
50	110	40	63,7	20	14000	9500	1,65	2310
50	110	40	43,6	14	-	4000	1,65	2310 2RSTN
50	110	40	63,7	20	14000	9500	1,55	2310 K
50	110	40	63,7	20	14000	9500	1,8	2310 M
55	100	21	27,6	10,6	14000	9000	0,71	1211 TN
55	100	25	27,6	10,6	-	4300	0,79	2211 2RSTN
55	100	25	39	13,4	12000	8500	0,81	2211 TN
55	120	29	50,7	18	11000	7500	1,6	1311 TN
55	120	43	76,1	24	11000	7500	2,1	2311
55	120	43	76,1	24	11000	7500	2	2311 K
55	120	43	76,1	24	11000	7500	2,3	2311 M
60	110	22	31,2	12,2	12000	8500	0,9	1212 TN
60	110	28	31,2	12,2	-	3800	1,05	2212 2RSTN
60	110	28	48,8	17	11000	8000	1,05	2212 TN
60	130	31	58,5	22	9000	6300	1,95	1312 TN
60	130	46	87,1	28,5	9500	7000	2,6	2312
60	130	46	87,1	28,5	9500	7000	2,5	2312 K
60	130	46	87,1	28,5	9500	7000	2,9	2312 M
60	150	42	125	41,5	9000	6300	3,95	1412 M
65	120	23	35,1	14	10000	7000	1,1	1213 TN
65	120	31	35,1	14	-	3600	1,4	2213 2RSTN
65	120	31	57,2	20	10000	7000	1,4	2213 TN
65	140	33	65	25,5	8500	6000	2,45	1313 TN
65	140	48	95,6	32,5	9000	6300	3,25	2313
65	140	48	95,6	32,5	9000	6300	3,1	2313 K
65	140	48	95,6	32,5	9000	6300	3,6	2313 M
70	125	24	35,8	14,6	11000	7000	1,25	1214 TN
70	125	31	44,2	17	10000	6700	1,5	2214
70	125	31	35,8	14,6	-	3400	1,45	2214 2RSTN
70	150	35	74,1	27,5	8500	6000	3	1314
70	150	51	111	37,5	8000	6000	3,9	2314
70	150	51	111	37,5	8000	6000	4,25	2314 M
75	130	25	39	15,6	10000	6700	1,35	1215
75	130	25	39	15,6	10000	6700	1,3	1215 K
75	130	31	58,5	22	9000	6300	1,5	2215 TN

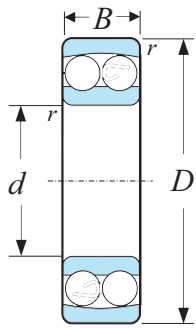

## SELF-ALIGNING BALL BEARINGS

### Cylindrical & Tapered Bore

Table 35  
Bore Diameter 75mm - 100mm

Principal Dimension			Basic Load Ratings		Speed Ratings		Mass	Designations
d	D	B	Dynamic Static		Ref. Speed	Limiting Speed	kg	Local
mm			C	C <sub>0</sub>	r/min			
75	160	37	79,3	30	8000	5600	3,55	1315
75	160	37	79,3	30	8000	5600	3,4	1315 K
75	160	37	79,3	30	8000	5600	3,95	1315 M
75	160	55	124	43	7500	5600	4,7	2315
75	160	55	124	43	7500	5600	4,45	2315 K
75	160	55	124	43	7500	5600	5,05	2315 EKTN
75	160	55	124	43	7500	5600	5,3	2315 M
80	140	26	39,7	17	9500	6000	1,65	1216
80	140	26	39,7	17	9500	6000	1,6	1216 K
80	140	33	65	25,5	8500	6000	1,9	2216 TN
80	170	39	88,4	33,5	7500	5300	4,2	1316
80	170	39	88,4	33,5	7500	5300	4,05	1316 K
80	170	58	135	49	7000	5300	6,1	2316
80	170	58	135	49	7000	5300	5,9	2316 K
80	170	58	135	49	7000	5300	6,05	2316 EKTN
80	170	58	135	49	7000	5300	6,25	2316 M
85	150	28	48,8	20,8	9000	5600	2,05	1217
85	150	28	48,8	20,8	9000	5600	2	1217 K
85	150	36	58,5	23,6	8000	5600	2,5	2217
85	150	36	58,5	23,6	8000	5600	2,4	2217 K
85	180	41	97,5	38	7000	4800	5	1317
85	180	41	97,5	38	7000	4800	4,9	1317 K
85	180	60	140	51	6700	4800	6,8	2317 EKTN
85	180	60	140	51	6700	4800	7,05	2317 M
90	160	30	57,2	23,6	8500	5300	2,5	1218
90	160	30	57,2	23,6	8500	5300	2,4	1218 K
90	160	40	70,2	28,5	7500	5300	3,4	2218
90	160	40	70,2	28,5	7500	5300	3,2	2218 K
90	190	43	117	44	6700	4500	5,8	1318
90	190	43	117	44	6700	4500	5,6	1318 K
90	190	64	153	57	6300	4500	8,2	2318 EKTN
90	190	64	153	57	6300	4500	8,45	2318 M
95	170	32	63,7	27	8000	5000	3,1	1219
95	170	32	63,7	27	8000	5000	3	1219 K
95	170	43	83,2	34,5	7000	5000	3,9	2219 EKTN
95	170	43	83,2	34,5	7000	5000	4,1	2219 M
95	200	45	133	51	6300	4300	6,7	1319
95	200	45	133	51	6300	4300	6,5	1319 K
95	200	67	165	64	6000	4500	9,8	2319 M
100	180	34	68,9	30	7500	4800	3,7	1220
100	180	34	68,9	30	7500	4800	3,6	1220 K
100	180	46	97,5	40,5	6700	4800	5,5	2220
100	180	46	97,5	40,5	6700	4800	4,8	2220 EKTN
100	180	46	97,5	40,5	6700	4800	5	2220 M
100	215	47	143	57	6000	4000	8,3	1320
100	215	47	143	57	6000	4000	8,05	1320 K
100	215	73	190	80	5600	4000	12	2320 EKTN
100	215	73	190	80	5600	4000	12,5	2320 M

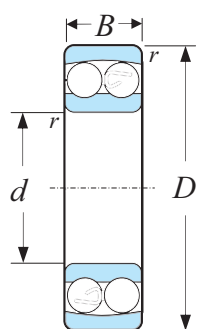

## SELF-ALIGNING BALL BEARINGS

Cylindrical & Tapered Bore

Table 36  
Bore Diameter 110mm - 150mm

Principal Dimension			Basic Load Ratings		Speed Ratings		Mass	Designations
d	D	B	Dynamic	Static	Ref. Speed	Limiting Speed		
mm			C	C <sub>0</sub>	r/min		kg	Local
110	200	38	88,4	39	6700	4300	5,15	1222
110	200	38	88,4	39	6700	4300	5	1222 K
110	200	53	124	52	6000	4300	6,5	2222
110	200	53	124	52	6000	4300	6,8	2222 EKTN
110	200	53	124	52	6000	4300	7,1	2222 M
110	240	50	163	72	5300	3600	11,5	1322 EKTN
110	240	50	163	72	5300	3600	12	1322 M
120	215	42	119	53	6300	4000	6,5	1224 EKTN
120	215	42	119	53	6300	4000	6,75	1224 M
130	230	46	127	58,5	5600	3600	8,3	1226 M

### SPHERICAL ROLLER BEARINGS

Spherical roller bearings are designed to be robust in carrying heavy loads, and intrinsically self-aligning, with its' barrel rollers that roll and align themselves freely at the sphere outer ring raceway. However, they must not subject to any axial loads. These bearings are double row, consisting of solid outer ring with a concave or sphere raceway, solid inner rings, and two rows of barrel rollers in the cage. Spherical roller bearings are available in both cylindrical and tapered bores. Its' main advantage over the self-aligning ball bearings is its' greater load carrying capacity.

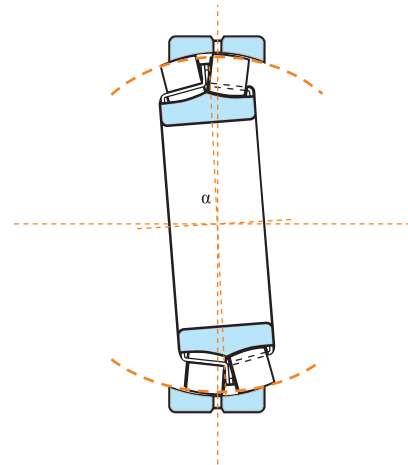
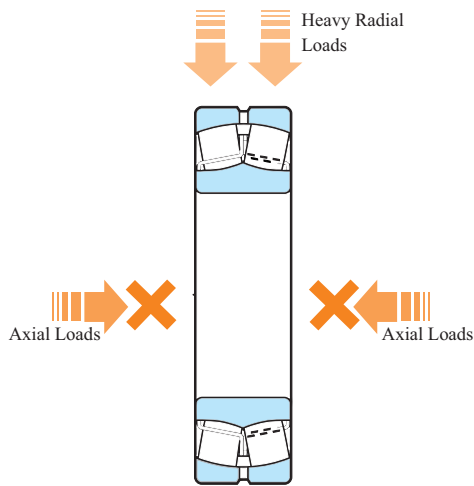
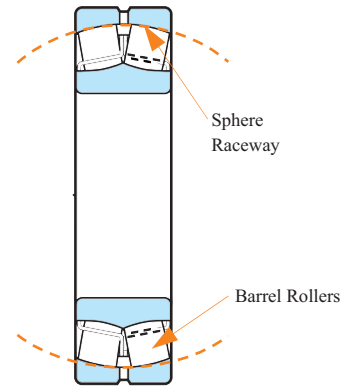

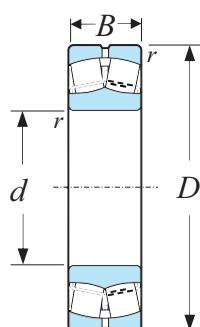

## SPHERICAL ROLLER BEARINGS

### Cylindrical & Tapered Bore

Table 37  
Bore Diameter 20mm - 65mm

Principal Dimension			Basic Load Ratings		Speed Ratings		Mass	Designations
d	D	B	Dynamic	Static	Ref. Speed	Limiting Speed		
mm			C	C <sub>0</sub>	r/min		kg	CT
25	52	18	49	44	13000	17000	0,26	22205 E
25	52	18	49	44	13000	17000	0,26	22205 EK
25	62	17	41,4	41,5	8500	12000	0,28	21305 CC
30	62	20	64	60	10000	14000	0,29	22206 E
30	62	20	64	60	10000	14000	0,28	22206 EK
30	72	19	55,2	61	7500	10000	0,41	21306 CC
30	72	19	55,2	61	7500	10000	0,4	21306 CCK
35	72	23	86,5	85	9000	12000	0,45	22207 E
35	72	23	86,5	85	9000	12000	0,44	22207 EK
35	80	21	65,6	72	6700	9500	0,55	21307 CC
35	80	21	65,6	72	6700	9500	0,54	21307 CCK
40	80	23	96,5	90	8000	11000	0,53	22208 E
40	80	23	96,5	90	8000	11000	0,52	22208 EK
40	90	23	104	108	7000	9500	0,75	21308 E
40	90	23	104	108	7000	9500	0,74	21308 EK
40	90	33	150	140	6000	8000	1,05	22308 E
40	90	33	150	140	6000	8000	1,05	22308 EK
45	85	23	102	98	7500	10000	0,58	22209 E
45	85	23	102	98	7500	10000	0,57	22209 EK
45	100	25	125	127	6300	8500	0,99	21309 E
45	100	25	125	127	6300	8500	0,98	21309 EK
45	100	36	183	183	5300	7000	1,4	22309 E
45	100	36	183	183	5300	7000	1,35	22309 EK
50	90	23	104	108	7000	9500	0,63	22210 E
50	90	23	104	108	7000	9500	0,62	22210 EK
50	110	27	156	166	5600	7500	1,35	21310 E
50	110	27	156	166	5600	7500	1,35	21310 EK
50	110	40	220	224	4800	6300	1,9	22310 E
50	110	40	220	224	4800	6300	1,85	22310 EK
55	100	25	125	127	6300	8500	0,84	22211 E
55	100	25	125	127	6300	8500	0,82	22211 EK
55	120	29	156	166	5600	7500	1,7	21311 E
55	120	29	156	166	5600	7500	1,7	21311 EK
55	120	43	270	280	4300	5600	2,45	22311 E
55	120	43	270	280	4300	5600	2,4	22311 EK
60	110	28	156	166	5600	7500	1,15	22212 E
60	110	28	156	166	5600	7500	1,15	22212 EK
60	130	31	212	240	4800	6300	2,1	21312 E
60	130	31	212	240	4800	6300	2,05	21312 EK
60	130	46	310	335	4000	5300	3,1	22312 E
60	130	46	310	335	4000	5300	3,05	22312 EK
65	100	35	132	173	4300	6300	0,95	24013 CC

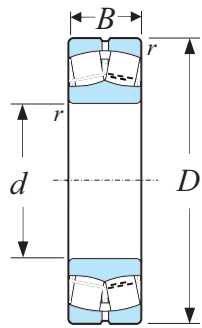

## SPHERICAL ROLLER BEARINGS

### Cylindrical & Tapered Bore

Table 38  
Bore Diameter 65mm - 90mm

Principal Dimension			Basic Load Ratings		Speed Ratings		Mass	Designations
d	D	B	Dynamic	Static	Ref. Speed	Limiting Speed		
mm			C	C <sub>0</sub>	r/min		kg	CT
65	100	35	132	173	4300	6300	0,93	24013 CCK30
65	120	31	193	216	5000	7000	1,55	22213 E
65	120	31	193	216	5000	7000	1,5	22213 EK
65	140	33	236	270	4300	6000	2,55	21313 E
65	140	33	236	270	4300	6000	2,5	21313 EK
65	140	48	340	360	3800	5000	3,75	22313 E
65	140	48	340	360	3800	5000	3,65	22313 EK
70	125	31	208	228	5000	6700	1,55	22214 E
70	125	31	208	228	5000	6700	1,5	22214 EK
70	150	35	285	325	4000	5600	3,1	21314 E
70	150	35	285	325	4000	5600	3,05	21314 EK
70	150	51	400	430	3400	4500	4,55	22314 E
70	150	51	400	430	3400	4500	4,45	22314 EK
75	115	40	173	232	3800	5300	1,55	24015 CC
75	115	40	173	232	3800	5300	1,55	24015 CCK30
75	130	31	212	240	4800	6300	1,7	22215 E
75	130	31	212	240	4800	6300	1,65	22215 EK
75	160	37	285	325	4000	5600	3,75	21315 E
75	160	37	285	325	4000	5600	3,7	21315 EK
75	160	55	440	475	3200	4300	5,55	22315 E
75	160	55	440	475	3200	4300	5,45	22315 EK
80	140	33	236	270	4300	6000	2,1	22216 E
80	140	33	236	270	4300	6000	2,05	22216 EK
80	170	39	325	375	3800	5300	4,45	21316 E
80	170	39	325	375	3800	5300	4,4	21316 EK
80	170	58	490	540	3000	4000	6,6	22316 E
80	170	58	490	540	3000	4000	6,45	22316 EK
85	150	36	285	325	4000	5600	2,65	22217 E
85	150	36	285	325	4000	5600	2,6	22217 EK
85	180	41	325	375	3800	5300	5,2	21317 E
85	180	41	325	375	3800	5300	5,15	21317 EK
85	180	60	550	620	2800	3800	7,65	22317 E
85	180	60	550	620	2800	3800	7,5	22317 EK
90	160	40	325	375	3800	5300	3,4	22218 E
90	160	40	325	375	3800	5300	3,35	22218 EK
90	160	52,4	355	440	2800	3800	4,65	23218 CC
90	160	52,4	355	440	2800	3800	4,5	23218 CCK

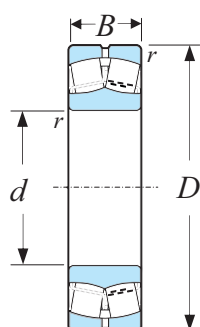

## SPHERICAL ROLLER BEARINGS

Cylindrical & Tapered Bore

Table 39  
Bore Diameter 90mm - 110mm

Principal Dimension			Basic Load Ratings		Speed Ratings		Mass	Designations
d	D	B	Dynamic	Static	Ref. Speed	Limiting Speed		
mm			C	C <sub>0</sub>	r/min		kg	CT
90	190	43	380	450	3600	4800	6,1	21318 E
90	190	43	380	450	3600	4800	6	21318 EK
90	190	64	610	695	2600	3600	9,05	22318 E
90	190	64	610	695	2600	3600	8,85	22318 EK
95	170	43	380	450	3600	4800	4,15	22219 E
95	170	43	380	450	3600	4800	4,05	22219 EK
95	200	45	425	490	3400	4500	7,05	21319 E
95	200	45	425	490	3400	4500	6,95	21319 EK
95	200	67	670	765	2600	3400	10,5	22319 E
95	200	67	670	765	2600	3400	10,5	22319 EK
100	150	50	285	415	2800	4000	3,15	24020 CC
100	165	52	365	490	3000	4000	4,55	23120 CC
100	165	52	365	490	3000	4000	4,4	23120 CCK
100	165	65	455	640	2400	3200	5,65	24120 CC
100	165	65	455	640	2400	3200	5,55	24120 CCK30
100	180	46	425	490	3400	4500	4,9	22220 E
100	180	46	425	490	3400	4500	4,8	22220 EK
100	180	60,3	475	600	2400	3400	6,85	23220 CC
100	180	60,3	475	600	2400	3400	6,65	23220 CCK
100	215	47	425	490	3400	4500	8,6	21320 E
100	215	47	425	490	3400	4500	8,5	21320 EK
100	215	73	815	950	2400	3000	13,5	22320 E
100	215	73	815	950	2400	3000	13	22320 EK
110	170	45	310	440	3400	4300	3,8	23022 CC
110	170	45	310	440	3400	4300	3,7	23022 CCK
110	170	60	415	620	2400	3600	5	24022 CC
110	170	60	415	620	2400	3600	4,9	24022 CCK30
110	180	56	430	585	2800	3600	5,75	23122 CC
110	180	56	430	585	2800	3600	5,55	23122 CCK
110	180	69	520	750	2200	3000	7,1	24122 CC
110	180	69	520	750	2200	3000	7	24122 CCK30
110	200	53	560	640	3000	4000	7	22222 E
110	200	53	560	640	3000	4000	6,85	22222 EK
110	200	69,8	600	765	2200	3200	9,85	23222 CC
110	200	69,8	600	765	2200	3200	9,55	23222 CCK
110	240	80	950	1120	2000	2800	18,4	22322 E



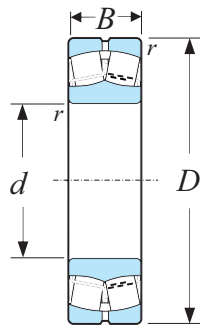

## SPHERICAL ROLLER BEARINGS

### Cylindrical & Tapered Bore

Table 40  
Bore Diameter 110mm - 140mm

Principal Dimension			Basic Load Ratings		Speed Ratings		Mass	Designations
d	D	B	Dynamic	Static	Ref. Speed	Limiting Speed		
mm			C	C <sub>0</sub>	r/min		kg	CT
110	240	80	950	1120	2000	2800	18	22322 EK
120	180	46	355	510	3200	4000	4,2	23024 CC
120	180	46	355	510	3200	4000	4,05	23024 CCK
120	180	60	430	670	2400	3400	5,45	24024 CC
120	180	60	430	670	2400	3400	5,35	24024 CCK30
120	200	62	510	695	2600	3400	8	23124 CC
120	200	62	510	695	2600	3400	7,75	23124 CCK
120	200	80	655	950	1900	2600	10,3	24124 CC
120	200	80	655	950	1900	2600	10	24124 CCK30
120	215	58	630	765	2800	3800	8,7	22224 E
120	215	58	630	765	2800	3800	8,5	22224 EK
120	215	76	695	930	2000	2800	12	23224 CC
120	215	76	695	930	2000	2800	11,5	23224 CCK
120	260	86	965	1120	2000	2600	23	22324 CC
120	260	86	965	1120	2000	2600	22,5	22324 CCK
130	200	52	430	610	2800	3600	6	23026 CC
130	200	52	430	610	2800	3600	5,8	23026 CCK
130	200	69	540	815	2000	3000	8,05	24026 CC
130	200	69	540	815	2000	3000	7,9	24026 CCK30
130	210	64	560	780	2400	3200	8,8	23126 CC
130	210	64	560	780	2400	3200	8,5	23126 CCK
130	210	80	680	1000	1800	2400	11	24126 CC
130	210	80	680	1000	1800	2400	11	24126 CCK30
130	230	64	735	930	2600	3600	11	22226 E
130	230	64	735	930	2600	3600	10,7	22226 EK
130	230	80	780	1060	1900	2600	14,5	23226 CC
130	230	80	780	1060	1900	2600	14	23226 CCK
130	280	93	1120	1320	1800	2400	29	22326 CC
130	280	93	1120	1320	1800	2400	28,5	22326 CCK
140	210	53	465	680	2600	3400	6,55	23028 CC
140	210	53	465	680	2600	3400	6,35	23028 CCK

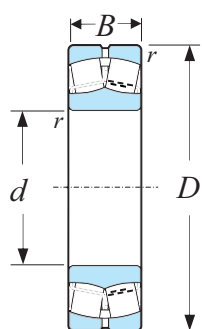

## SPHERICAL ROLLER BEARINGS

Cylindrical & Tapered Bore

Table 41  
Bore Diameter 140mm - 150mm

Principal Dimension			Basic Load Ratings		Speed Ratings		Mass	Designations
d	D	B	Dynamic	Static	Ref. Speed	Limiting Speed		
mm			C	C <sub>0</sub>	r/min		kg	CT
140	210	69	570	900	2000	2800	8,55	24028 CC
140	210	69	570	900	2000	2800	8,4	24028 CCK30
140	225	68	630	900	2200	2800	10,5	23128 CC
140	225	68	630	900	2200	2800	10	23128 CCK
140	225	85	765	1160	1700	2400	13,5	24128 CC
140	225	85	765	1160	1700	2400	13,5	24128 CCK30
140	250	68	710	900	2400	3200	14	22228 CC
140	250	68	710	900	2400	3200	13,5	22228 CCK
140	250	88	915	1250	1700	2400	19	23228 CC
140	250	88	915	1250	1700	2400	18,5	23228 CCK
140	300	102	1290	1560	1700	2200	36,5	22328 CC
140	300	102	1290	1560	1700	2200	36	22328 CCK
150	225	56	510	750	2400	3200	7,95	23030 CC
150	225	56	510	750	2400	3200	7,7	23030 CCK
150	225	75	655	1040	1800	2600	10,5	24030 CC
150	225	75	655	1040	1800	2600	10,5	24030 CCK30
150	250	80	830	1200	2000	2600	16	23130 CC
150	250	80	830	1200	2000	2600	15,5	23130 CCK
150	250	100	1020	1530	1500	2200	20	24130 CC
150	250	100	1020	1530	1500	2200	19,5	24130 CCK30
150	270	73	850	1080	2200	3000	18	22230 CC
150	270	73	850	1080	2200	3000	17,5	22230 CCK
150	270	96	1080	1460	1600	2200	24,5	23230 CC
150	270	96	1080	1460	1600	2200	24	23230 CCK
150	320	108	1460	1760	1600	2000	43,5	22330 CC
150	320	108	1460	1760	1600	2000	42,5	22330 CCK

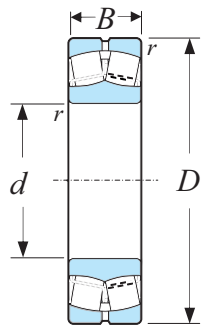

## SPHERICAL ROLLER BEARINGS

### Cylindrical & Tapered Bore

Table 42  
Bore Diameter 140mm - 160mm

Principal Dimension			Basic Load Ratings		Speed Ratings		Mass	Designations
d	D	B	Dynamic	Static	Ref. Speed	Limiting Speed		
mm			C	C <sub>0</sub>	r/min		kg	CT
140	210	69	570	900	2000	2800	8,55	24028 CC
140	210	69	570	900	2000	2800	8,4	24028 CCK30
140	225	68	630	900	2200	2800	10,5	23128 CC
140	225	68	630	900	2200	2800	10	23128 CCK
140	225	85	765	1160	1700	2400	13,5	24128 CC
140	225	85	765	1160	1700	2400	13,5	24128 CCK30
140	250	68	710	900	2400	3200	14	22228 CC
140	250	68	710	900	2400	3200	13,5	22228 CCK
140	250	88	915	1250	1700	2400	19	23228 CC
140	250	88	915	1250	1700	2400	18,5	23228 CCK
140	300	102	1290	1560	1700	2200	36,5	22328 CC
140	300	102	1290	1560	1700	2200	36	22328 CCK
150	225	56	510	750	2400	3200	7,95	23030 CC
150	225	56	510	750	2400	3200	7,7	23030 CCK
150	225	75	655	1040	1800	2600	10,5	24030 CC
150	225	75	655	1040	1800	2600	10,5	24030 CCK30
150	250	80	830	1200	2000	2600	16	23130 CC
150	250	80	830	1200	2000	2600	15,5	23130 CCK
150	250	100	1020	1530	1500	2200	20	24130 CC
150	250	100	1020	1530	1500	2200	19,5	24130 CCK30
150	270	73	850	1080	2200	3000	18	22230 CC
150	270	73	850	1080	2200	3000	17,5	22230 CCK
150	270	96	1080	1460	1600	2200	24,5	23230 CC
150	270	96	1080	1460	1600	2200	24	23230 CCK
150	320	108	1460	1760	1600	2000	43,5	22330 CC
150	320	108	1460	1760	1600	2000	42,5	22330 CCK
160	240	60	585	880	2400	3000	9,7	23032 CC
160	240	60	585	880	2400	3000	9,4	23032 CCK

## THRUST BALL BEARINGS

Thrust ball bearings are a combination of shaft locating washer, housing locating washer, and ball and cage thrust assemblies. Thrust ball bearings are designed to specifically carry axial loads, but must not be subjected to any radial loads. They are available in single direction and double directions.

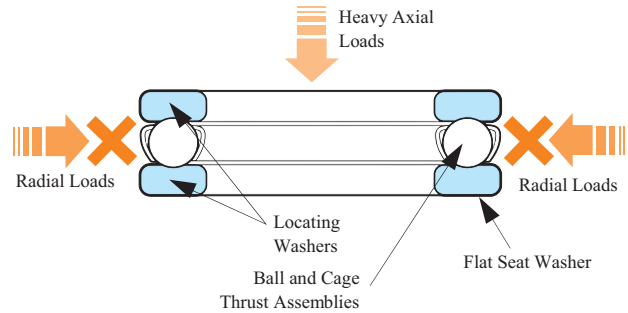

### Single Direction Thrust Ball Bearings

Single direction thrust ball bearings consist of one shaft washer, one housing washer, and one set of roller and cage assemblies. It is designed to be separable, the washer and the ball and cage assemblies can be mounted separately, so that the mounting can be done easily. Some smaller sizes of the bearings are available with options of flat washer or spherical housing washer. Spherical seat washer can be applied together with spherical housing washer in order to compensate shaft deflection or misalignment.

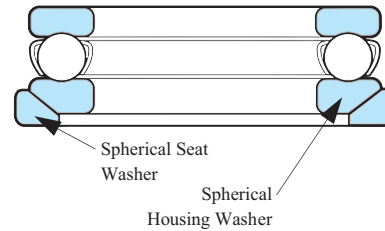

### Double Directions Thrust Ball Bearings

Double direction thrust ball bearings consist of one shaft washer, two housing washer and two sets of ball and cage assemblies. Similarly to single direction bearings, the bearings are separable and mounting can be done easily. Again, some smaller sizes of the bearings are available with options of flat washer or spherical housing washer. Spherical seat washer can be applied together with spherical housing washer in order to compensate shaft deflection or misalignment. Double direction thrust ball bearings have capability to carry axial loads acting in both directions. But they must not be subject to any radial loads.

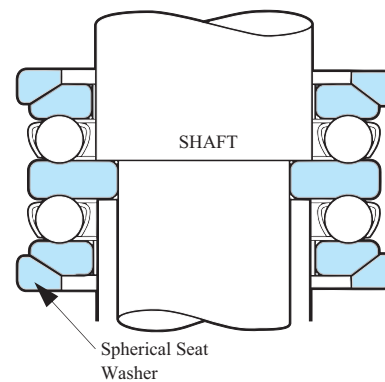
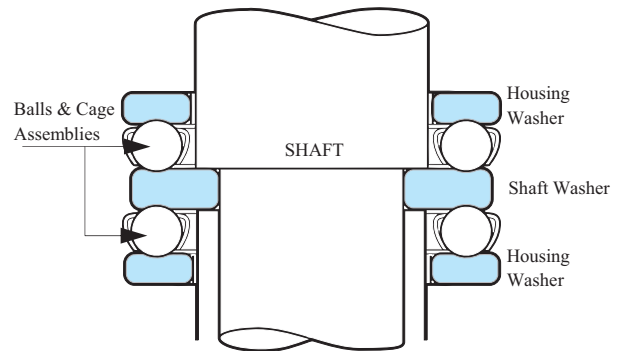

## THRUST BALL BEARINGS

### Single Direction

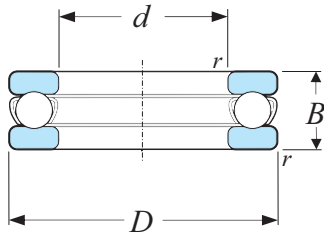
 Table 43  
 Bore Diameter 10mm - 70mm

Principal Dimension			Basic Load Ratings		Speed Ratings		Mass	Designations
d	D	B	Dynamic	Static	Ref. Speed	Limiting Speed		
mm			C	C <sub>0</sub>	r/min		kg	CT
10	24	9	9,95	15,3	9500	13000	0,02	51100
10	26	11	12,7	18,6	8000	11000	0,03	51200
12	26	9	10,4	16,6	9000	13000	0,022	51101
12	28	11	13,3	20,8	8000	11000	0,034	51201
15	28	9	10,6	18,3	8500	12000	0,024	51102
15	32	12	16,5	27	7000	10000	0,045	51202
17	30	9	11,4	21,2	8500	12000	0,026	51103
17	35	12	17,2	30	6700	9500	0,053	51203
20	35	10	15,1	29	7500	10000	0,039	51104
20	40	14	22,5	40,5	6000	8000	0,082	51204
25	42	11	18,2	39	6300	9000	0,06	51105
25	47	15	27,6	55	5300	7500	0,11	51205
25	52	18	34,5	60	4500	6300	0,12	51305
25	60	24	55,3	96,5	3600	5000	0,34	51405
30	47	11	19	43	6000	8500	0,069	51106
30	52	16	25,5	51	4800	6700	0,13	51206
30	60	21	37,7	71	3800	5300	0,26	51306
30	70	28	72,8	137	3000	4300	0,52	51406
35	52	12	19,9	51	5600	7500	0,08	51107
35	62	18	35,1	73,5	4000	5600	0,22	51207
35	68	24	49,4	96,5	3200	4500	0,39	51307
35	80	32	87,1	170	2600	3800	0,74	51407
40	60	13	26	63	5000	7000	0,12	51108
40	68	19	46,8	106	3800	5300	0,27	51208
40	78	26	61,8	122	3000	4300	0,53	51308
40	90	36	112	224	2400	3400	1,1	51408
45	65	14	26,5	69,5	4500	6300	0,15	51109
45	73	20	39	86,5	3600	5000	0,32	51209
45	85	28	76,1	153	2800	4000	0,66	51309
45	100	39	130	265	2200	3000	1,42	51409
50	70	14	27	75	4300	6300	0,16	51110
50	78	22	49,4	116	3400	4500	0,37	51210
50	95	31	88,4	190	2600	3600	0,94	51310
50	110	43	159	340	2000	2800	2	51410
55	78	16	30,7	85	3800	5300	0,24	51111
55	90	25	61,8	146	2800	4000	0,59	51211
55	105	35	104	224	2200	3200	1,3	51311
55	120	48	178	390	1800	2400	2,55	51411
60	85	17	41,6	122	3600	5000	0,3	51112
60	95	26	62,4	150	2800	3800	0,65	51212
60	110	35	101	224	2200	3000	1,35	51312
60	130	51	199	430	1600	2200	3,1	51412 MP
65	90	18	37,7	108	3400	4800	0,33	51113
65	100	27	63,7	163	2600	3600	0,78	51213
65	115	36	106	240	2000	3000	1,5	51313
65	140	56	216	490	1500	2200	4	51413 MP
70	95	18	40,3	120	3400	4500	0,35	51114
70	105	27	65	173	2600	3600	0,79	51214
70	125	40	135	320	1900	2600	2	51314
70	150	60	234	550	1400	2000	5	51414 MP

## THRUST BALL BEARINGS Single Direction

Table 44  
Bore Diameter 75mm - 180mm

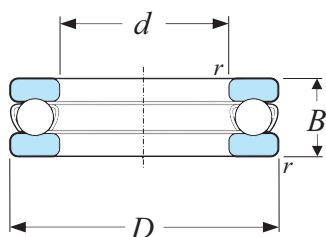

Principal Dimension			Basic Load Ratings		Speed Ratings		Mass	Designations
d	D	B	Dynamic	Static	Ref. Speed	Limiting Speed		
mm			C	C <sub>0</sub>	r/min		kg	CT
75	100	19	44,2	146	3200	4300	0,4	51115
75	110	27	67,6	183	2400	3400	0,83	51215
75	135	44	163	390	1700	2400	2,6	51315
75	160	65	251	610	1300	1800	6,75	51415 MP
80	105	19	44,9	153	3000	4300	0,42	51116
80	115	28	76,1	208	2400	3400	0,91	51216
80	140	44	159	390	1700	2400	2,7	51316
80	170	68	270	670	1200	1700	7,95	51416 MP
85	110	19	46,2	163	3000	4300	0,44	51117
85	125	31	97,5	275	2200	3000	1,2	51217
85	150	49	190	465	1600	2200	3,55	51317
85	180	72	286	750	1200	1600	9,45	51417 MP
90	120	22	59,2	208	2600	3800	0,65	51118
90	135	35	119	325	2000	2800	1,7	51218
90	155	50	195	500	1500	2200	3,8	51318
90	190	77	307	815	1100	1500	11	51418 MP
100	135	25	85,2	290	2400	3200	0,97	51120
100	135	25	79,3	260	2400	3200	0,97	51120 MP
100	150	38	124	345	1800	2400	2,2	51220
100	170	55	229	610	1400	1900	4,95	51320
100	210	85	371	1060	950	1400	15	51420 MP
110	145	25	87,1	315	2200	3200	1,05	51122
110	160	38	130	390	1700	2400	2,4	51222
110	190	63	281	815	1200	1700	7,85	51322 MP
110	230	95	410	1220	900	1300	20	51422 MP
120	155	25	88,4	335	2200	3000	1,15	51124
120	170	39	140	440	1600	2200	2,65	51224
120	210	70	325	980	1100	1500	11	51324 MP
120	250	102	520	1730	800	1100	29,5	51424 MP
130	170	30	111	425	1900	2600	1,85	51126
130	190	45	186	585	1400	2000	4	51226
130	225	75	358	1140	1000	2400	13	51326 MP
130	270	110	520	1730	750	1000	32	51426 MP
140	180	31	111	440	1800	2600	2,05	51128
140	200	46	190	620	1400	1900	4,35	51228
140	240	80	397	1320	950	1300	15,5	51328 MP
140	280	112	520	1730	700	1000	34,5	51428 MP
150	190	31	111	440	1700	2400	2,2	51130 MP
150	215	50	238	800	1300	1800	6,1	51230 MP
150	250	80	410	1400	900	1300	16,5	51330 MP
150	300	120	559	1960	670	950	42,5	51430 MP
160	200	31	112	465	1700	2400	2,35	51132 MP
160	225	51	242	850	1200	1700	6,55	51232 MP
160	270	87	449	1660	850	1200	21	51332 MP
170	215	34	133	540	1600	2200	3,3	51134 MP
170	240	55	286	1020	1100	1800	8,15	51234 MP
170	280	87	468	1760	800	1100	22	51334 MP
180	225	34	135	570	1500	2200	3,5	51136 MP
180	250	56	296	1080	1100	1500	8,6	51236 MP
180	300	95	520	2000	750	1100	28,5	51336 MP

## THRUST BALL BEARINGS

### Single Direction

Table 45  
Bore Diameter 190mm - 220mm

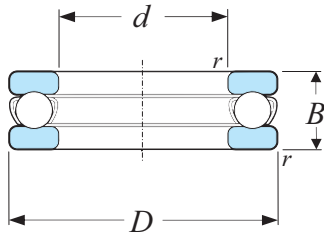

Principal Dimension			Basic Load Ratings		Speed Ratings		Mass	Designations
d	D	B	Dynamic	Static	Ref. Speed	Limiting Speed		
mm			C	C <sub>0</sub>	r/min		kg	CT
190	240	37	172	710	1400	2000	4,05	51138 MP
190	270	62	332	1270	1000	1400	12	51238 MP
190	320	105	592	2400	700	950	36,5	51338 MP
200	250	37	168	710	1400	1900	4,25	51140 MP
200	280	62	338	1320	1000	1400	12	51240 MP
200	340	110	624	2600	630	900	44,5	51340 MP
220	270	37	178	800	1300	1900	4,6	51144 MP
220	300	63	351	1460	950	1300	13	51244 MP

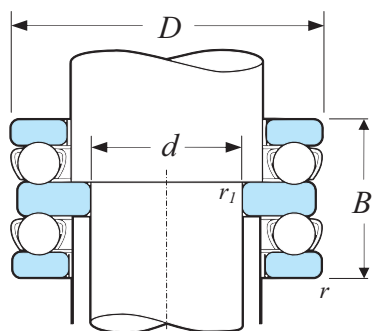

## THRUST BALL BEARINGS Double Direction

Table 46  
Bore Diameter 10mm - 150mm

Principal Dimension			Basic Load Ratings		Speed Ratings		Mass	Designations
d	D	B	Dynamic	Static	Ref. Speed	Limiting Speed		
mm			C	C <sub>0</sub>	r/min		kg	CT
10	32	22	16,5	27	7000	10000	0,084	52202
15	40	26	22,5	40,5	6000	8000	0,15	52204
20	47	28	27,6	55	5300	7500	0,22	52205
20	52	34	34,5	60	4500	6300	0,33	52305
20	70	52	72,8	137	3000	4300	1	52406
25	52	29	25,5	51	4800	6700	0,25	52206
25	60	38	37,7	71	3800	5300	0,45	52306
25	80	59	87,1	170	2600	3800	1,37	52407
30	62	34	35,1	73,5	4000	5600	0,41	52207
30	68	36	46,8	106	3800	5300	0,55	52208
30	68	44	49,4	96,5	3200	4500	0,68	52307
30	78	49	61,8	122	3000	4300	1,05	52308
30	90	65	112	224	2400	3400	2,05	52408
35	73	37	39	86,5	3600	5000	0,6	52209
35	85	52	76,1	153	2800	4000	1,24	52309
35	100	72	130	265	2200	3000	2,7	52409
40	78	39	49,4	116	3400	4500	0,67	52210
40	95	58	88,4	190	2600	3600	1,75	52310
45	90	45	61,8	146	2800	4000	1,1	52211
45	105	64	104	224	2200	3200	2,4	52311
45	120	87	178	390	1800	2400	4,7	52411
50	95	46	62,4	150	2800	3800	1,16	52212
50	110	64	101	224	2200	3000	2,55	52312
50	130	93	199	430	1600	2200	6,35	52412 M
55	100	47	63,7	163	2600	3600	1,35	52213
55	105	47	65	173	2600	3600	1,5	52214
55	115	65	106	240	2000	3000	2,75	52313
55	125	72	135	320	1900	2600	3,65	52314
55	150	107	234	550	1400	2000	9,7	52414 M
60	110	47	67,6	183	2400	3400	1,55	52215
60	135	79	163	390	1700	2400	4,8	52315
65	115	48	76,1	208	2400	3400	1,7	52216
65	140	79	159	390	1700	2400	4,94	52316
70	125	55	97,5	275	2200	3000	2,4	52217
75	135	62	119	325	2000	2800	3,2	52218
85	150	67	124	345	1800	2400	4,2	52220
85	170	97	229	610	1400	1900	8,95	52320
95	160	67	130	390	1700	2400	4,65	52222
100	170	68	140	440	1600	2200	5,25	52224
110	190	80	186	585	1400	2000	8	52226
120	200	81	190	620	1400	1900	8,65	52228
130	215	89	238	800	1300	1800	11,5	52230 M
140	225	90	242	850	1200	1700	12	52232 M
150	240	97	286	1020	1100	1800	15	52234 M
150	250	98	296	1080	1100	1500	16	52236 M



## THRUST SPHERICAL ROLLER BEARINGS

Thrust spherical roller bearings are most suitable for applications of radial loads and simultaneously acting axial loads. The loads of the bearings are transmitted from raceway to another at a certain angle to the bearing axis. Self-aligning capability is the most important feature and characteristic of thrust spherical roller bearings, the bearings are insensitive to misalignment or deflection of shaft relatively to the bearing center. Thrust spherical roller bearings are designed with large numbers of asymmetrical or barrel rollers, and specially designed raceway with an optimized conformity, so that they are mostly used to support very heavy axial loads under a considerably high speed operations.

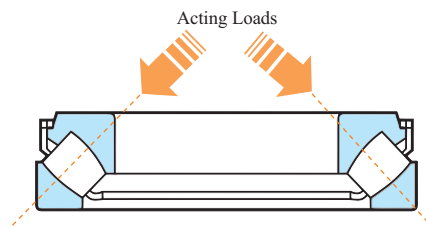
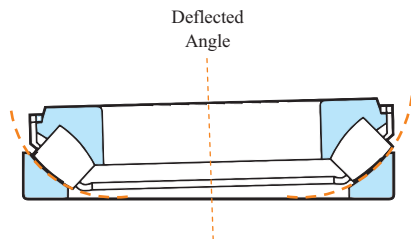
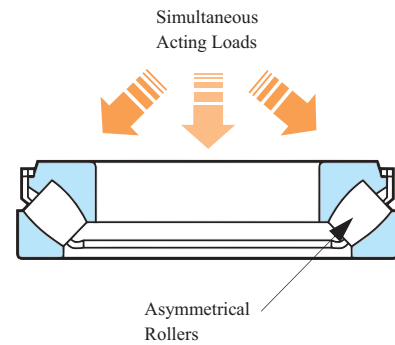

## THRUST SPHERICAL ROLLER BEARINGS

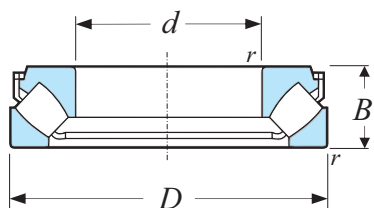

Table 47  
Bore Diameter 60mm - 220mm

Principal Dimension			Basic Load Ratings		Speed Ratings		Mass	Designations
d	D	B	Dynamic	Static	Ref. Speed	Limiting Speed		
mm			C	C <sub>0</sub>	r/min		kg	CT
60	130	42	390	915	2800	5000	2,6	29412
65	140	45	455	1080	2600	4800	3,2	29413
70	150	48	520	1250	2400	4300	3,9	29414
75	160	51	600	1430	2400	4000	4,7	29415
80	170	54	670	1630	2200	3800	5,6	29416
85	150	39	380	1060	2400	4000	2,75	29317
85	180	58	735	1800	2000	3600	6,75	29417
90	155	39	400	1080	2400	4000	2,85	29318
90	190	60	815	2000	1900	3400	7,75	29418
100	170	42	465	1290	2200	3600	3,65	29320
100	210	67	980	2500	1700	3000	10,5	29420
110	190	48	610	1730	1900	3200	5,3	29322
110	230	73	1180	3000	1600	2800	13,5	29422
120	210	54	765	2120	1700	2800	7,35	29324
120	250	78	1370	3450	1500	2600	17,5	29424
130	225	58	865	2500	1600	2600	9	29326
130	270	85	1560	4050	1300	2400	22	29426
140	240	60	980	2850	1500	2600	10,5	29328
140	280	85	1630	4300	1300	2400	23	29428
150	215	39	408	1600	1800	2800	4,3	29230
150	250	60	1000	2850	1500	2400	11	29330
150	300	90	1860	5100	1200	2200	28	29430
160	270	67	1180	3450	1300	2200	14,5	29332
160	320	95	2080	5600	1100	2000	33,5	29432
170	280	67	1200	3550	1300	2200	15	29334
170	340	103	2360	6550	1100	1900	44,5	29434
180	250	42	495	2040	1600	2600	5,8	29236 E
180	300	73	1430	4300	1200	2000	19,5	29336
180	360	109	2600	7350	1000	1800	52,5	29436
190	320	78	1630	4750	1100	1900	23,5	29338
190	380	115	2850	8000	950	1700	60,5	29438
200	280	48	656	2650	1400	2200	9,3	29240 E
200	340	85	1860	5500	1000	1700	29,5	29340
200	400	122	3200	9000	850	1600	72	29440
220	300	48	690	3000	1300	2200	10	29244 E
220	360	85	2000	6300	1000	1700	33,5	29344
220	420	122	3350	9650	850	1500	75	29444

## CYLINDRICAL ROLLER BEARINGS

Cylindrical roller bearings are available in many designs, such as single row cylindrical roller bearing with cage, and full complement type (without cage) of cylindrical roller bearings. Bearings with cage are designed to accommodate heavy loads and high speed operations, whereas the full complement type of bearings are mostly suitable where there is very heavy loads at moderate speed operations.

### Single Row Cylindrical Roller Bearings

The rings of single row cylindrical roller bearings are flanged on one of the rings that guide the rollers during operation. These are sometimes called the "open" flanges. The rollers' end surfaces are particularly treated to have better lubrication, lower friction, and lower operating temperature, when they roll by the "open" flanges. Its' separable design of rings the roller and cage assemblies facilitating a better and easier mounting and dismounting job.

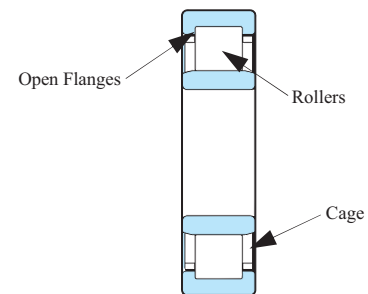

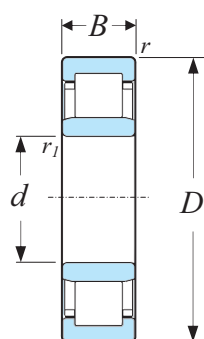

## CYLINDRICAL ROLLER BEARINGS Single Row

Table 48  
Bore Diameter 15mm - 25mm

Principal Dimension			Basic Load Ratings		Speed Ratings		Mass	Designations
d	D	B	Dynamic Static		Ref. Speed	Limiting Speed		
mm			C	C <sub>0</sub>	r/min		kg	CT
			kN					
15	35	11	12,5	10,2	22000	26000	0,049	NJ 202 T
15	35	11	12,5	10,2	22000	26000	0,047	NU 202 T
15	35	11	12,5	10,2	22000	34000	0,047	NU 202 T
17	40	12	17,2	14,3	19000	22000	0,066	N 203 T
17	40	12	17,2	14,3	19000	34000	0,07	NJ 203 M
17	40	12	17,2	14,3	19000	22000	0,07	NJ 203 T
17	40	12	17,2	14,3	19000	34000	0,068	NU 203 M
17	40	12	17,2	14,3	19000	22000	0,068	NU 203 T
17	40	12	17,2	14,3	19000	22000	0,073	NUP 203 T
17	40	16	23,8	21,6	19000	22000	0,095	NJ 2203 T
17	40	16	23,8	21,6	19000	22000	0,092	NU 2203 T
17	40	16	23,8	21,6	19000	22000	0,097	NUP 2203 T
17	47	14	24,6	20,4	15000	20000	0,12	N 303 T
17	47	14	24,6	20,4	15000	20000	0,12	NJ 303 T
17	47	14	24,6	20,4	15000	20000	0,12	NU 303 T
20	47	14	25,1	22	16000	19000	0,11	N 204 T
20	47	14	25,1	22	16000	19000	0,12	NF 204 T
20	47	14	25,1	22	16000	30000	0,11	NJ 204 M
20	47	14	25,1	22	16000	19000	0,11	NJ 204 T
20	47	14	25,1	22	16000	30000	0,11	NU 204 M
20	47	14	25,1	22	16000	19000	0,11	NU 204 T
20	47	14	25,1	22	16000	24000	0,11	NU 204 T
20	47	14	25,1	22	16000	30000	0,12	NUP 204 M
20	47	14	25,1	22	16000	19000	0,12	NUP 204 T
20	47	18	29,7	27,5	16000	19000	0,14	NJ 2204 T
20	47	18	29,7	27,5	16000	19000	0,14	NU 2204 T
20	52	15	35,5	26	15000	18000	0,15	N 304 T
20	52	15	35,5	26	15000	18000	0,17	NJ 304 T
20	52	15	35,5	26	15000	18000	0,17	NU 304 T
20	52	15	35,5	26	15000	18000	0,16	NUP 304 T
20	52	21	47,5	38	15000	18000	0,22	NJ 2304 T
20	52	21	47,5	38	15000	18000	0,21	NU 2304 T
20	52	21	47,5	38	15000	18000	0,22	NUP 2304 T
25	47	12	14,2	13,2	18000	18000	0,084	NU 1005
25	52	15	28,6	27	14000	16000	0,13	N 205 T
25	52	15	28,6	27	14000	16000	0,15	NJ 205 W
25	52	15	28,6	27	14000	26000	0,15	NJ 205 M
25	52	15	28,6	27	14000	16000	0,15	NJ 205 T
25	52	15	28,6	27	14000	16000	0,14	NU 205 W
25	52	15	28,6	27	14000	26000	0,14	NU 205 M
25	52	15	28,6	27	14000	16000	0,14	NU 205 T
25	52	15	28,6	27	14000	16000	0,14	NUP 205 M
25	52	15	28,6	27	14000	16000	0,14	NUP 205 T
25	52	18	34,1	34	14000	16000	0,18	NJ 2205 T
25	52	18	34,1	34	14000	26000	0,17	NU 2205 M
25	52	18	34,1	34	14000	16000	0,17	NU 2205 T
25	52	18	34,1	34	14000	16000	0,17	NUP 2205 T
25	62	17	46,5	36,5	12000	15000	0,24	N 305 T

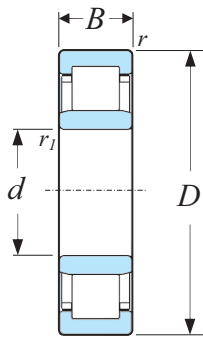

## CYLINDRICAL ROLLER BEARINGS

### Single Row

Table 49  
Bore Diameter 25mm - 30mm

Principal Dimension			Basic Load Ratings		Speed Ratings		Mass	Designations
d	D	B	Dynamic Static		Ref. Speed	Limiting Speed		
mm			C	C <sub>0</sub>	r/min		kg	CT
25	62	17	46,5	36,5	12000	15000	0,29	NJ 305 W
25	62	17	46,5	36,5	12000	22000	0,29	NJ 305 M
25	62	17	46,5	36,5	12000	15000	0,29	NJ 305 T
25	62	17	46,5	36,5	12000	15000	0,28	NU 305 W
25	62	17	46,5	36,5	12000	22000	0,28	NU 305 M
25	62	17	46,5	36,5	12000	15000	0,28	NU 305 T
25	62	17	46,5	36,5	12000	15000	0,25	NUP 305 W
25	62	17	46,5	36,5	12000	22000	0,25	NUP 305 M
25	62	17	46,5	36,5	12000	15000	0,25	NUP 305 T
25	62	24	64	55	12000	15000	0,42	NJ 2305 M
25	62	24	64	55	12000	15000	0,39	NJ 2305 T
25	62	24	64	55	12000	15000	0,38	NU 2305 W
25	62	24	64	55	12000	22000	0,41	NU 2305 M
25	62	24	64	55	12000	15000	0,38	NU 2305 T
25	62	24	64	55	12000	22000	0,41	NUP 2305 M
25	62	24	64	55	12000	15000	0,38	NUP 2305 T
30	55	13	17,9	17,3	15000	15000	0,12	NU 1006
30	62	16	44	36,5	13000	14000	0,2	N 206 M
30	62	16	44	36,5	13000	14000	0,2	N 206 T
30	62	16	44	36,5	13000	14000	0,24	NJ 206 W
30	62	16	44	36,5	13000	22000	0,24	NJ 206 M
30	62	16	44	36,5	13000	14000	0,24	NJ 206 T
30	62	16	44	36,5	13000	14000	0,23	NU 206 W
30	62	16	44	36,5	13000	22000	0,23	NU 206 M
30	62	16	44	36,5	13000	14000	0,23	NU 206 T
30	62	16	44	36,5	13000	22000	0,22	NUP 206 M
30	62	16	44	36,5	13000	14000	0,22	NUP 206 T
30	62	20	55	49	13000	14000	0,27	NJ 2206 W
30	62	20	55	49	13000	14000	0,27	NJ 2206 T
30	62	20	55	49	13000	14000	0,26	NU 2206 W
30	62	20	55	49	13000	22000	0,29	NU 2206 M
30	62	20	55	49	13000	14000	0,26	NU 2206 T
30	62	20	55	49	13000	14000	0,27	NUP 2206 T
30	72	19	58,5	48	11000	12000	0,36	N 306 T
30	72	19	58,5	48	11000	12000	0,41	NJ 306 W
30	72	19	58,5	48	11000	12000	0,41	NJ 306 M
30	72	19	58,5	48	11000	19000	0,41	NJ 306 M
30	72	19	58,5	48	11000	12000	0,41	NJ 306 T
30	72	19	58,5	48	11000	12000	0,4	NU 306 W
30	72	19	58,5	48	11000	12000	0,44	NU 306 M
30	72	19	58,5	48	11000	19000	0,44	NU 306 M
30	72	19	58,5	48	11000	12000	0,4	NU 306 T
30	72	19	58,5	48	11000	12000	0,38	NUP 306 W
30	72	19	58,5	48	11000	12000	0,38	NUP 306 M
30	72	19	58,5	48	11000	19000	0,38	NUP 306 M
30	72	19	58,5	48	11000	12000	0,38	NUP 306 M
30	72	19	58,5	48	11000	12000	0,38	NUP 306 T
30	72	27	83	75	11000	19000	0,58	NJ 2306 M
30	72	27	83	75	11000	12000	0,54	NJ 2306 T

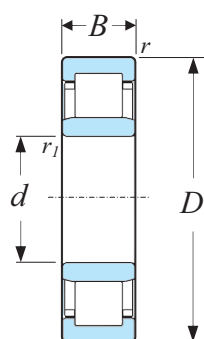

## CYLINDRICAL ROLLER BEARINGS Single Row

Table 50  
Bore Diameter 30mm - 35mm

Principal Dimension			Basic Load Ratings		Speed Ratings		Mass	Designations
d	D	B	Dynamic Static		Ref. Speed	Limiting Speed		
mm			C	C <sub>0</sub>	r/min		kg	CT
			kN					
30	72	27	83	75	11000	19000	0,57	NU 2306 M
30	72	27	83	75	11000	12000	0,53	NU 2306 T
30	72	27	83	75	11000	19000	0,55	NUP 2306 M
30	72	27	83	75	11000	12000	0,55	NUP 2306 T
30	90	23	60,5	53	9000	11000	0,77	NJ 406
30	90	23	60,5	53	9000	14000	0,83	NJ 406 M
30	90	23	60,5	53	9000	11000	0,75	NU 406
30	90	23	60,5	53	9000	14000	0,81	NU 406 M
35	62	14	35,8	38	12000	20000	0,16	NU 1007 M
35	62	14	35,8	38	12000	13000	0,16	NU 1007 T
35	72	17	56	48	11000	12000	0,33	N 207 M
35	72	17	56	48	11000	12000	0,3	N 207 T
35	72	17	56	48	11000	12000	0,32	NJ 207 W
35	72	17	56	48	11000	12000	0,34	NJ 207 M
35	72	17	56	48	11000	18000	0,34	NJ 207 M
35	72	17	56	48	11000	12000	0,31	NJ 207 T
35	72	17	56	48	11000	12000	0,31	NU 207 W
35	72	17	56	48	11000	12000	0,33	NU 207 M
35	72	17	56	48	11000	12000	0,3	NU 207 T
35	72	17	56	48	11000	12000	0,33	NUP 207 W
35	72	17	56	48	11000	12000	0,36	NUP 207 M
35	72	17	56	48	11000	12000	0,32	NUP 207 T
35	72	23	69,5	63	11000	12000	0,4	N 2207 M
35	72	23	69,5	63	11000	12000	0,41	NJ 2207 W
35	72	23	69,5	63	11000	12000	0,41	NJ 2207 M
35	72	23	69,5	63	11000	12000	0,41	NJ 2207 T
35	72	23	69,5	63	11000	12000	0,4	NU 2207 W
35	72	23	69,5	63	11000	18000	0,4	NU 2207 M
35	72	23	69,5	63	11000	12000	0,4	NU 2207 T
35	72	23	69,5	63	11000	12000	0,42	NUP 2207 T
35	80	21	75	63	9500	11000	0,55	N 307 M
35	80	21	75	63	9500	11000	0,48	N 307 T
35	80	21	75	63	9500	11000	0,55	NJ 307 W
35	80	21	75	63	9500	11000	0,59	NJ 307 M
35	80	21	75	63	9500	17000	0,59	NJ 307 M
35	80	21	75	63	9500	11000	0,55	NJ 307 T
35	80	21	75	63	9500	17000	0,58	NU 307 W
35	80	21	75	63	9500	17000	0,58	NU 307 M
35	80	21	75	63	9500	11000	0,58	NU 307 M
35	80	21	75	63	9500	11000	0,54	NU 307 T
35	80	21	75	63	9500	11000	0,54	NU 307 T
35	80	21	75	63	9500	11000	0,51	NUP 307 W
35	80	21	75	63	9500	17000	0,57	NUP 307 M

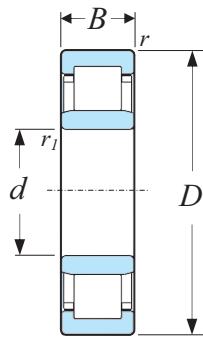

## CYLINDRICAL ROLLER BEARINGS

### Single Row

 Table 51  
 Bore Diameter 35mm - 40mm

Principal Dimension			Basic Load Ratings		Speed Ratings		Mass	Designations
d	D	B	C	C <sub>0</sub>	Ref. Speed	Limiting Speed		
mm			kN		r/min		kg	CT
35	80	21	75	63	9500	11000	0,51	NUP 307 T
35	80	31	106	98	9500	11000	0,73	NJ 2307 T
35	80	31	106	98	9500	11000	0,72	NU 2307 W
35	80	31	106	98	9500	11000	0,72	NU 2307 T
35	80	31	106	98	9500	11000	0,75	NUP 2307 T
35	100	25	76,5	69,5	8000	9500	1,05	N 407
35	100	25	76,5	69,5	8000	9500	1,05	NJ 407
35	100	25	76,5	69,5	8000	9500	1,05	NJ 407 T
35	100	25	76,5	69,5	8000	9500	1	NU 407
40	68	15	25,1	26	12000	18000	0,22	NU 1008 M
40	80	18	62	53	9500	14000	0,41	N 208 M
40	80	18	62	53	9500	11000	0,37	N 208 T
40	80	18	62	53	9500	11000	0,4	NF 208 T
40	80	18	62	53	9500	11000	0,43	NJ 208 W
40	80	18	62	53	9500	11000	0,43	NJ 208 M
40	80	18	62	53	9500	16000	0,43	NJ 208 M
40	80	18	62	53	9500	11000	0,43	NJ 208 T
40	80	18	62	53	9500	11000	0,42	NU 208 W
40	80	18	62	53	9500	11000	0,4	NU 208 M
40	80	18	62	53	9500	11000	0,42	NU 208 T
40	80	18	62	53	9500	11000	0,4	NUP 208 W
40	80	18	62	53	9500	11000	0,44	NUP 208 M
40	80	18	62	53	9500	11000	0,4	NUP 208 T
40	80	23	81,5	75	9500	11000	0,55	NJ 2208 W
40	80	23	81,5	75	9500	16000	0,58	NJ 2208 M
40	80	23	81,5	75	9500	11000	0,55	NJ 2208 T
40	80	23	81,5	75	9500	11000	0,54	NU 2208 W
40	80	23	81,5	75	9500	16000	0,58	NU 2208 M
40	80	23	81,5	75	9500	11000	0,54	NU 2208 T
40	80	23	81,5	75	9500	11000	0,56	NUP 2208 W
40	80	23	81,5	75	9500	11000	0,56	NUP 2208 T
40	90	23	93	78	8000	9500	0,64	N 308 M
40	90	23	93	78	8000	9500	0,64	N 308 T
40	90	23	93	78	8000	9500	0,68	NF 308 T
40	90	23	93	78	8000	9500	0,75	NJ 308 W
40	90	23	93	78	8000	9500	0,81	NJ 308 M
40	90	23	93	78	8000	15000	0,81	NJ 308 M
40	90	23	93	78	8000	9500	0,75	NJ 308 T
40	90	23	93	78	8000	9500	0,73	NU 308 W
40	90	23	93	78	8000	9500	0,79	NU 308 M
40	90	23	93	78	8000	9500	0,73	NU 308 T
40	90	23	93	78	8000	9500	0,68	NUP 308 M
40	90	23	93	78	8000	9500	0,68	NUP 308 T
40	90	33	129	120	8000	9500	0,96	NJ 2308 W
40	90	33	129	120	8000	15000	1,04	NJ 2308 M
40	90	33	129	120	8000	9500	0,96	NJ 2308 T

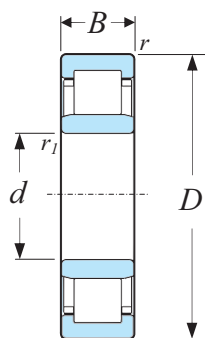

## CYLINDRICAL ROLLER BEARINGS Single Row

Table 52  
Bore Diameter 40mm - 45mm

Principal Dimension			Basic Load Ratings		Speed Ratings		Mass	Designations
d	D	B	Dynamic	Static	Ref. Speed	Limiting Speed		
mm			C	C <sub>0</sub>	r/min		kg	CT
40	90	33	129	120	8000	9500	0,94	NU 2308 W
40	90	33	129	120	8000	15000	1,02	NU 2308 M
40	90	33	129	120	8000	9500	0,94	NU 2308 T
40	90	33	129	120	8000	15000	0,98	NUP 2308 M
40	90	33	129	120	8000	9500	0,98	NUP 2308 T
40	110	27	96,8	90	7000	8500	1,35	NJ 408
40	110	27	96,8	90	7000	11000	1,45	NJ 408 M
40	110	27	96,8	90	7000	8500	1,3	NU 408
40	110	27	96,8	90	7000	11000	1,4	NU 408 M
45	75	16	44,6	52	9500	11000	0,27	NJ 1009 T
45	75	16	44,6	52	9500	11000	0,26	NU 1009 T
45	75	19	52,8	64	9000	11000	0,34	NJ 2009 T
45	85	19	69,5	64	9000	9500	0,43	N 209 M
45	85	19	69,5	64	9000	9500	0,43	N 209 T
45	85	19	69,5	64	9000	9500	0,49	NJ 209 W
45	85	19	69,5	64	9000	9500	0,49	NJ 209 M
45	85	19	69,5	64	9000	9500	0,49	NJ 209 T
45	85	19	69,5	64	9000	9500	0,48	NU 209 W
45	85	19	69,5	64	9000	9500	0,46	NU 209 M
45	85	19	69,5	64	9000	9500	0,48	NU 209 T
45	85	19	69,5	64	9000	9500	0,45	NUP 209 W
45	85	19	69,5	64	9000	9500	0,45	NUP 209 M
45	85	19	69,5	64	9000	9500	0,45	NUP 209 T
45	85	23	85	81,5	9000	9500	0,55	N 2209 W
45	85	23	85	81,5	9000	9500	0,54	NJ 2209 W
45	85	23	85	81,5	9000	9500	0,54	NJ 2209 M
45	85	23	85	81,5	9000	9500	0,54	NJ 2209 T
45	85	23	85	81,5	9000	9500	0,52	NU 2209 W
45	85	23	85	81,5	9000	9500	0,52	NU 2209 T
45	85	23	85	81,5	9000	9500	0,55	NUP 2209 T
45	100	25	112	100	7500	8500	0,88	N 309 T
45	100	25	112	100	7500	8500	1,05	NJ 309 W
45	100	25	112	100	7500	8500	1,13	NJ 309 M
45	100	25	112	100	7500	8500	1,05	NJ 309 T
45	100	25	112	100	7500	8500	1	NU 309 W
45	100	25	112	100	7500	8500	1,08	NU 309 M
45	100	25	112	100	7500	8500	1	NU 309 T
45	100	25	112	100	7500	8500	0,95	NUP 309 W
45	100	25	112	100	7500	13000	0,95	NUP 309 M
45	100	25	112	100	7500	8500	0,95	NUP 309 T



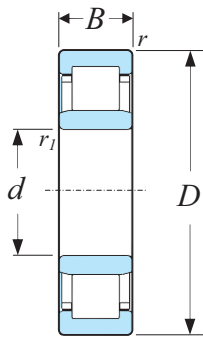

## CYLINDRICAL ROLLER BEARINGS

### Single Row

 Table 53  
 Bore Diameter 45mm - 50mm

Principal Dimension			Basic Load Ratings		Speed Ratings		Mass	Designations
d	D	B	Dynamic Static		Ref. Speed	Limiting Speed		
mm			C	C <sub>0</sub>	r/min		kg	CT
45	100	36	160	153	7500	13000	1,45	NJ 2309 M
45	100	36	160	153	7500	8500	1,35	NJ 2309 T
45	100	36	160	153	7500	13000	1,4	NU 2309 M
45	100	36	160	153	7500	8500	1,3	NU 2309 T
45	100	36	160	153	7500	13000	1,35	NUP 2309 M
45	100	36	160	153	7500	8500	1,35	NUP 2309 T
45	120	29	106	102	6700	7500	1,7	NJ 409
45	120	29	106	102	6700	10000	1,83	NJ 409 M
45	120	29	106	102	6700	7500	1,65	NU 409
50	80	16	46,8	56	9000	9500	0,35	NU 1010 T
50	80	16	30,8	34,5	10000	15000	0,31	NU 1010 M
50	90	20	73,5	69,5	8500	9000	0,48	N 210 T
50	90	20	73,5	69,5	8500	9000	0,5	NJ 210 W
50	90	20	73,5	69,5	8500	9000	0,5	NJ 210 M
50	90	20	73,5	69,5	8500	14000	0,5	NJ 210 M
50	90	20	73,5	69,5	8500	9000	0,5	NJ 210 T
50	90	20	73,5	69,5	8500	9000	0,49	NU 210 W
50	90	20	73,5	69,5	8500	9000	0,57	NU 210 M
50	90	20	73,5	69,5	8500	9000	0,49	NU 210 T
50	90	20	73,5	69,5	8500	9000	0,51	NUP 210 W
50	90	20	73,5	69,5	8500	14000	0,51	NUP 210 M
50	90	20	73,5	69,5	8500	9000	0,51	NUP 210 T
50	90	23	90	88	8500	9000	0,61	NJ 2210 W
50	90	23	90	88	8500	14000	0,62	NJ 2210 M
50	90	23	90	88	8500	9000	0,59	NJ 2210 T
50	90	23	90	88	8500	9000	0,59	NJ 2210 T
50	90	23	90	88	8500	9000	0,56	NU 2210 W
50	90	23	90	88	8500	9000	0,6	NU 2210 M
50	90	23	90	88	8500	14000	0,6	NU 2210 M
50	90	23	90	88	8500	9000	0,56	NU 2210 T
50	90	23	73,5	69,5	8500	9000	0,49	NUB 210 T
50	90	23	90	88	8500	9000	0,59	NUP 2210 W
50	90	23	90	88	8500	14000	0,63	NUP 2210 M
50	90	23	90	88	8500	9000	0,59	NUP 2210 T
50	110	27	127	112	6700	8000	1,15	N 310 M
50	110	27	127	112	6700	8000	1,15	N 310 T
50	110	27	127	112	6700	8000	1,2	NF 310 T
50	110	27	127	112	6700	8000	1,16	NJ 310 W
50	110	27	127	112	6700	8000	1,26	NJ 310 M
50	110	27	127	112	6700	8000	1,15	NJ 310 T
50	110	27	127	112	6700	8000	1,16	NU 310 W
50	110	27	127	112	6700	8000	1,24	NU 310 M
50	110	27	127	112	6700	12000	1,24	NU 310 M
50	110	27	127	112	6700	8000	1,15	NU 310 T
50	110	27	127	112	6700	8000	1,2	NUP 310 W
50	110	27	127	112	6700	8000	1,2	NUP 310 M

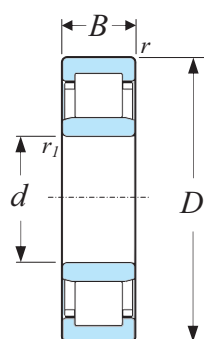

## CYLINDRICAL ROLLER BEARINGS Single Row

Table 54  
Bore Diameter 50mm - 55mm

Principal Dimension			Basic Load Ratings		Speed Ratings		Mass	Designations
d	D	B	Dynamic	Static	Ref. Speed	Limiting Speed		
mm			C	C <sub>0</sub>	r/min		kg	CT
50	110	27	127	112	6700	12000	1,2	NUP 310 M
50	110	27	127	112	6700	8000	1,2	NUP 310 T
50	110	40	186	186	6700	12000	2,05	NJ 2310 M
50	110	40	186	186	6700	8000	1,75	NJ 2310 T
50	110	40	186	186	6700	12000	2	NU 2310 M
50	110	40	186	186	6700	8000	1,7	NU 2310 T
50	110	40	186	186	6700	12000	1,8	NUP 2310 M
50	110	40	186	186	6700	8000	1,8	NUP 2310 T
50	130	31	130	127	6000	7000	2,05	NJ 410
50	130	31	130	127	6000	7000	2	NU 410
55	90	18	57,2	69,5	8000	8500	0,42	NJ 1011 T
55	90	18	57,2	69,5	8000	8500	0,4	NU 1011 T
55	100	21	96,5	95	7500	8000	0,66	N 211 M
55	100	21	96,5	95	7500	8000	0,66	N 211 T
55	100	21	96,5	95	7500	8000	0,73	NF 211 M
55	100	21	96,5	95	7500	8000	0,69	NJ 211 W
55	100	21	96,5	95	7500	8000	0,73	NJ 211 M
55	100	21	96,5	95	7500	8000	0,67	NJ 211 T
55	100	21	96,5	95	7500	8000	0,69	NU 211 W
55	100	21	96,5	95	7500	8000	0,72	NU 211 M
55	100	21	96,5	95	7500	8000	0,67	NU 211 T
55	100	21	96,5	95	7500	8000	0,69	NUP 211 W
55	100	21	96,5	95	7500	8000	0,69	NUP 211 M
55	100	21	96,5	95	7500	8000	0,69	NUP 211 T
55	100	25	114	118	7500	8000	0,81	NJ 2211 W
55	100	25	114	118	7500	8000	0,87	NJ 2211 M
55	100	25	114	118	7500	8000	0,81	NJ 2211 T
55	100	25	114	118	7500	8000	0,79	NU 2211 W
55	100	25	114	118	7500	13000	0,85	NU 2211 M
55	100	25	114	118	7500	8000	0,79	NU 2211 T
55	100	25	114	118	7500	8000	0,82	NUP 2211 W
55	100	25	114	118	7500	8000	0,82	NUP 2211 T
55	120	29	156	143	6000	7000	1,57	N 311 M
55	120	29	156	143	6000	7000	1,45	N 311 T
55	120	29	156	143	6000	7000	1,5	NJ 311 W
55	120	29	156	143	6000	7000	1,58	NJ 311 M
55	120	29	156	143	6000	7000	1,5	NJ 311 T
55	120	29	156	143	6000	7000	1,45	NU 311 W
55	120	29	156	143	6000	7000	1,57	NU 311 M
55	120	29	156	143	6000	7000	1,45	NU 311 T
55	120	29	156	143	6000	7000	1,55	NUP 311 W

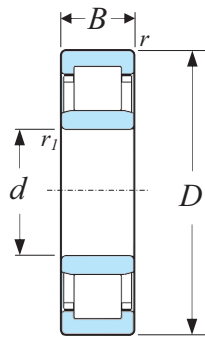

## CYLINDRICAL ROLLER BEARINGS

### Single Row

 Table 55  
 Bore Diameter 55mm - 60mm

Principal Dimension			Basic Load Ratings		Speed Ratings		Mass	Designations
d	D	B	Dynamic Static		Ref. Speed	Limiting Speed		
mm			C	C <sub>0</sub>	r/min		kg	CT
			kN					
55	120	29	156	143	6000	7000	1,55	NUP 311 M
55	120	29	156	143	6000	7000	1,55	NUP 311 T
55	120	43	232	232	6000	11000	2,48	NJ 2311 M
55	120	43	232	232	6000	7000	2,3	NJ 2311 T
55	120	43	232	232	6000	11000	2,43	NU 2311 M
55	120	43	232	232	6000	7000	2,25	NU 2311 T
55	120	43	232	232	6000	11000	2,43	NUP 2311 M
55	120	43	232	232	6000	7000	2,35	NUP 2311 T
55	140	33	142	140	5600	6300	2,55	NJ 411
55	140	33	142	140	5600	6300	2,5	NU 411
60	95	18	37,4	44	8000	13000	0,48	NU 1012 M
60	110	22	108	102	6700	7500	0,81	N 212 M
60	110	22	108	102	6700	7500	0,81	N 212 T
60	110	22	108	102	6700	7500	0,82	NJ 212 W
60	110	22	108	102	6700	7500	0,83	NJ 212 M
60	110	22	108	102	6700	7500	0,83	NJ 212 T
60	110	22	108	102	6700	7500	0,83	NU 212 W
60	110	22	108	102	6700	7500	0,87	NU 212 M
60	110	22	108	102	6700	7500	0,81	NU 212 T
60	110	22	108	102	6700	7500	0,88	NUP 212 W
60	110	22	108	102	6700	7500	0,86	NUP 212 M
60	110	22	108	102	6700	7500	0,86	NUP 212 T
60	110	28	146	153	6700	7500	1,15	NJ 2212 W
60	110	28	146	153	6700	7500	1,15	NJ 2212 M
60	110	28	146	153	6700	7500	1,15	NJ 2212 T
60	110	28	146	153	6700	7500	1,1	NU 2212 W
60	110	28	146	153	6700	7500	1,1	NU 2212 M
60	110	28	146	153	6700	7500	1,1	NU 2212 T
60	110	28	146	153	6700	7500	1,15	NUP 2212 W
60	110	28	146	153	6700	7500	1,15	NUP 2212 M
60	110	28	146	153	6700	7500	1,15	NUP 2212 T
60	130	31	173	160	5600	6700	1,8	N 312 W
60	130	31	173	160	5600	6700	1,8	N 312 M
60	130	31	173	160	5600	6700	1,8	N 312 T
60	130	31	173	160	5600	6700	1,9	NJ 312 W
60	130	31	173	160	5600	6700	2	NJ 312 M
60	130	31	173	160	5600	6700	1,9	NJ 312 T
60	130	31	173	160	5600	6700	1,8	NU 312 W
60	130	31	173	160	5600	6700	1,95	NU 312 M
60	130	31	173	160	5600	6700	1,8	NU 312 T
60	130	31	173	160	5600	6700	1,95	NUP 312 W

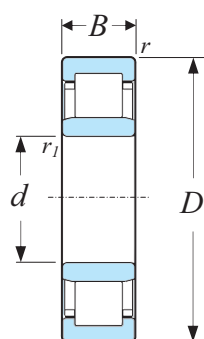

## CYLINDRICAL ROLLER BEARINGS Single Row

Table 56  
Bore Diameter 60mm - 65mm

Principal Dimension			Basic Load Ratings		Speed Ratings		Mass	Designations
d	D	B	Dynamic Static		Ref. Speed	Limiting Speed		
mm			C	C <sub>0</sub>	r/min		kg	CT
			kN					
60	130	31	173	160	5600	6700	1,95	NUP 312 M
60	130	31	173	160	5600	6700	1,95	NUP 312 T
60	130	46	260	265	5600	6700	2,8	NJ 2312 M
60	130	46	260	265	5600	6700	2,8	NJ 2312 T
60	130	46	260	265	5600	6700	3,15	NU 2312 M
60	130	46	260	265	5600	10000	3,15	NU 2312 M
60	130	46	260	265	5600	6700	2,75	NU 2312 T
60	130	46	260	265	5600	10000	2,85	NUP 2312 M
60	130	46	260	265	5600	6700	2,85	NUP 2312 T
60	150	35	168	173	5000	6000	3,1	NJ 412
60	150	35	168	173	5000	6000	3	NU 412
65	100	18	62,7	81,5	7000	7500	0,45	NU 1013 T
65	100	18	38	46,5	7500	12000	0,51	NU 1013 M
65	100	26	105	146	6300	7500	0,7	NJ 3013 T
65	120	23	122	118	6300	6700	1,05	N 213 T
65	120	23	122	118	6300	6700	1,07	NJ 213 W
65	120	23	122	118	6300	6700	1,07	NJ 213 M
65	120	23	122	118	6300	6700	1,07	NJ 213 T
65	120	23	122	118	6300	6700	1,1	NU 213 W
65	120	23	122	118	6300	6700	1,16	NU 213 M
65	120	23	122	118	6300	6700	1,05	NU 213 T
65	120	23	122	118	6300	6700	1,1	NUP 213 W
65	120	23	122	118	6300	10000	1,1	NUP 213 M
65	120	23	122	118	6300	6700	1,1	NUP 213 T
65	120	31	170	180	6300	6700	1,45	NJ 2213 W
65	120	31	170	180	6300	10000	1,45	NJ 2213 M
65	120	31	170	180	6300	6700	1,45	NJ 2213 T
65	120	31	170	180	6300	6700	1,4	NU 2213 W
65	120	31	170	180	6300	10000	1,4	NU 2213 M
65	120	31	170	180	6300	6700	1,4	NU 2213 T
65	120	31	170	180	6300	6700	1,5	NUP 2213 T
65	140	33	212	196	5300	6000	2,25	N 313 M
65	140	33	212	196	5300	6000	2,25	N 313 T
65	140	33	212	196	5300	6000	2,33	NJ 313 W
65	140	33	212	196	5300	6000	2,5	NJ 313 M
65	140	33	212	196	5300	6000	2,3	NJ 313 T
65	140	33	212	196	5300	6000	2,28	NU 313 W
65	140	33	212	196	5300	9500	2,43	NU 313 M
65	140	33	212	196	5300	6000	2,25	NU 313 T
65	140	33	212	196	5300	6000	2,35	NUP 313 W
65	140	33	212	196	5300	9500	2,35	NUP 313 M
65	140	33	212	196	5300	6000	2,35	NUP 313 T
65	140	48	285	290	5300	9500	3,6	NJ 2313 M

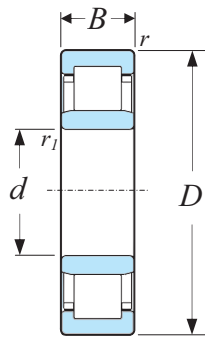

## CYLINDRICAL ROLLER BEARINGS

### Single Row

Table 57  
Bore Diameter 65mm - 70mm

Principal Dimension			Basic Load Ratings		Speed Ratings		Mass	Designations
d	D	B	Dynamic	Static	Ref. Speed	Limiting Speed		
mm			C	C <sub>0</sub>	r/min		kg	CT
			kN					
65	140	48	285	290	5300	6000	3,35	NJ 2313 T
65	140	48	285	290	5300	9500	3,4	NU 2313 M
65	140	48	285	290	5300	6000	3,3	NU 2313 T
65	140	48	285	290	5300	9500	3,45	NUP 2313 M
65	140	48	285	290	5300	6000	3,45	NUP 2313 T
65	160	37	183	190	4800	5600	3,65	NJ 413
65	160	37	183	190	4800	5600	3,95	NJ 413 M
65	160	37	183	190	4800	5600	3,6	NU 413
70	110	20	76,5	93	6300	7000	0,62	NU 1014 T
70	110	20	56,1	67,2	7000	11000	0,8	NU 1014 M
70	125	24	137	137	6000	6300	1,15	N 214 T
70	125	24	137	137	6000	6300	1,2	NJ 214 W
70	125	24	137	137	6000	6300	1,25	NJ 214 M
70	125	24	137	137	6000	6300	1,15	NJ 214 T
70	125	24	137	137	6000	6300	1,2	NU 214 W
70	125	24	137	137	6000	6300	1,25	NU 214 M
70	125	24	137	137	6000	6300	1,15	NU 214 T
70	125	24	137	137	6000	6300	1,2	NUP 214 M
70	125	24	137	137	6000	6300	1,2	NUP 214 T
70	125	31	180	193	6000	6300	1,7	NJ 2214 M
70	125	31	180	193	6000	6300	1,55	NJ 2214 T
70	125	31	180	193	6000	6300	1,55	NU 2214 W
70	125	31	180	193	6000	6300	1,55	NU 2214 M
70	125	31	180	193	6000	6300	1,5	NU 2214 T
70	125	31	180	193	6000	6300	1,75	NUP 2214 M
70	125	31	180	193	6000	6300	1,55	NUP 2214 T
70	150	35	236	228	4800	5600	2,75	N 314 M
70	150	35	236	228	4800	5600	2,75	N 314 M
70	150	35	236	228	4800	5600	2,75	N 314 T
70	150	35	236	228	4800	5600	2,8	NJ 314 W
70	150	35	236	228	4800	5600	3,05	NJ 314 M
70	150	35	236	228	4800	8500	3,05	NJ 314 M
70	150	35	236	228	4800	5600	2,8	NJ 314 T
70	150	35	236	228	4800	5600	2,75	NU 314 W
70	150	35	236	228	4800	5600	3	NU 314 M
70	150	35	236	228	4800	5600	2,75	NU 314 T
70	150	35	236	228	4800	5600	2,85	NUP 314 M
70	150	35	236	228	4800	5600	2,85	NUP 314 T
70	150	51	315	325	4800	8500	4,4	NJ 2314 M
70	150	51	315	325	4800	5600	4,05	NJ 2314 T

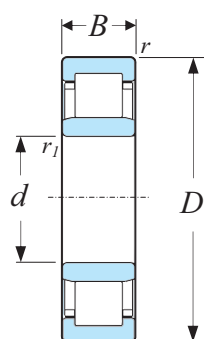

## CYLINDRICAL ROLLER BEARINGS Single Row

Table 58  
Bore Diameter 70mm - 75mm

Principal Dimension			Basic Load Ratings		Speed Ratings		Mass	Designations
d	D	B	Dynamic Static		Ref. Speed	Limiting Speed		
mm			C	C <sub>0</sub>	r/min		kg	CT
			kN					
70	150	51	315	325	4800	8500	4,35	NU 2314 M
70	150	51	315	325	4800	5600	4	NU 2314 T
70	150	51	315	325	4800	8500	4,15	NUP 2314 M
70	150	51	315	325	4800	5600	4,15	NUP 2314 T
70	180	42	229	240	4300	5000	5,2	N 414
70	180	42	229	240	4300	5000	5,35	NJ 414
70	180	42	229	240	4300	5000	5,25	NU 414
70	180	42	229	240	4300	5000	5,25	NU 414 M
75	115	20	58,3	71	6700	10000	0,74	NU 1015 M
75	130	25	150	156	5600	6000	1,25	N 215 T
75	130	25	150	156	5600	6000	1,4	NJ 215 W
75	130	25	150	156	5600	6000	1,3	NJ 215 M
75	130	25	150	156	5600	6000	1,3	NJ 215 T
75	130	25	150	156	5600	6000	1,27	NU 215 W
75	130	25	150	156	5600	6000	1,35	NU 215 M
75	130	25	150	156	5600	6000	1,25	NU 215 T
75	130	25	150	156	5600	6000	1,3	NUP 215 W
75	130	25	150	156	5600	6000	1,3	NUP 215 M
75	130	25	150	156	5600	6000	1,3	NUP 215 T
75	130	31	186	208	5600	9500	1,6	NJ 2215 W
75	130	31	186	208	5600	6000	1,6	NJ 2215 M
75	130	31	186	208	5600	6000	1,6	NJ 2215 T
75	130	31	186	208	5600	6000	1,6	NU 2215 W
75	130	31	186	208	5600	6000	1,6	NU 2215 T
75	130	31	186	208	5600	6000	1,65	NUP 2215 W
75	130	31	186	208	5600	9500	1,65	NUP 2215 M
75	130	31	186	208	5600	6000	1,65	NUP 2215 T
75	160	37	280	265	4500	5300	3,3	N 315 M
75	160	37	280	265	4500	5300	3,3	N 315 T
75	160	37	280	265	4500	5300	3,35	NJ 315 W
75	160	37	280	265	4500	5300	3,65	NJ 315 M
75	160	37	280	265	4500	5300	3,35	NJ 315 T
75	160	37	280	265	4500	5300	3,3	NU 315 W
75	160	37	280	265	4500	5300	3,6	NU 315 M
75	160	37	280	265	4500	8000	3,6	NU 315 M
75	160	37	280	265	4500	5300	3,3	NU 315 T
75	160	37	280	265	4500	5300	3,45	NUP 315 M
75	160	37	280	265	4500	5300	3,45	NUP 315 T
75	160	55	380	400	4500	8000	5,4	NJ 2315 M
75	160	55	380	400	4500	5300	5	NJ 2315 T
75	160	55	380	400	4500	5300	4,93	NU 2315 W
75	160	55	380	400	4500	8000	4,93	NU 2315 M
75	160	55	380	400	4500	5300	4,9	NU 2315 T

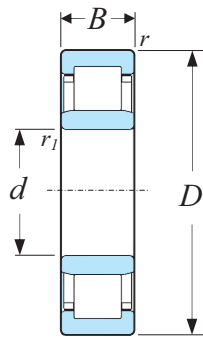

## CYLINDRICAL ROLLER BEARINGS

### Single Row

Table 59  
Bore Diameter 75mm - 80mm

Principal Dimension			Basic Load Ratings		Speed Ratings		Mass	Designations
d	D	B	Dynamic Static		Ref. Speed	Limiting Speed		
mm			C	C <sub>0</sub>	r/min		kg	CT
75	160	55	380	400	4500	8000	5,1	NUP 2315 M
75	160	55	380	400	4500	5300	5,1	NUP 2315 T
75	190	45	264	280	4000	4800	6,9	NJ 415
75	190	45	264	280	4000	4800	6,25	NU 415
75	190	45	264	280	4000	6300	6,75	NU 415 M
80	125	22	99	127	5600	9500	1,1	NJ 1016 M
80	125	22	66	81,4	6300	6300	1	NU 1016
80	125	22	99	127	5600	6000	1,1	NU 1016 M
80	140	26	160	166	5300	5600	1,5	N 216 T
80	140	26	160	166	5300	5600	1,6	NJ 216 W
80	140	26	160	166	5300	5600	1,6	NJ 216 M
80	140	26	160	166	5300	5600	1,55	NJ 216 T
80	140	26	160	166	5300	5600	1,5	NU 216 W
80	140	26	160	166	5300	5600	1,65	NU 216 M
80	140	26	160	166	5300	5600	1,5	NU 216 T
80	140	26	160	166	5300	8500	1,65	NUP 216 M
80	140	26	160	166	5300	5600	1,65	NUP 216 T
80	140	33	212	245	5300	5600	2,05	NJ 2216 W
80	140	33	212	245	5300	5600	2,05	NJ 2216 M
80	140	33	212	245	5300	5600	2,05	NJ 2216 T
80	140	33	212	245	5300	5600	2	NU 2216 W
80	140	33	212	245	5300	5600	2	NU 2216 M
80	140	33	212	245	5300	5600	2	NU 2216 T
80	140	33	212	245	5300	5600	2,1	NUP 2216 W
80	140	33	212	245	5300	5600	2,1	NUP 2216 M
80	140	33	212	245	5300	5600	2,1	NUP 2216 T
80	170	39	300	290	4300	5000	3,9	N 316 M
80	170	39	300	290	4300	5000	3,9	N 316 T
80	170	39	300	290	4300	5000	4,05	NJ 316 W
80	170	39	300	290	4300	5000	4,7	NJ 316 M
80	170	39	300	290	4300	5000	4	NJ 316 T
80	170	39	300	290	4300	5000	3,95	NU 316 W
80	170	39	300	290	4300	5000	4,65	NU 316 M
80	170	39	300	290	4300	5000	3,95	NU 316 T
80	170	39	300	290	4300	5000	4,1	NUP 316 M
80	170	39	300	290	4300	5000	4,1	NUP 316 T
80	170	58	415	440	4300	5000	6	NJ 2316 M
80	170	58	415	440	4300	5000	6	NJ 2316 T
80	170	58	415	440	4300	5000	5,95	NU 2316 M
80	170	58	415	440	4300	5000	5,95	NU 2316 T

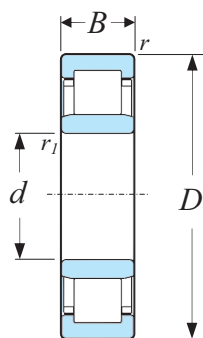

## CYLINDRICAL ROLLER BEARINGS Single Row

Table 60  
Bore Diameter 80mm - 85mm

Principal Dimension			Basic Load Ratings		Speed Ratings		Mass	Designations
d	D	B	Dynamic Static		Ref. Speed	Limiting Speed		
mm			C	C <sub>0</sub>	r/min		kg	CT
80	170	58	415	440	4300	7500	6,6	NUP 2316 M
80	170	58	415	440	4300	5000	6,6	NUP 2316 T
80	200	48	303	320	3800	4500	7,45	NJ 416
80	200	48	303	320	3800	4500	8,05	NJ 416 M
80	200	48	303	320	3800	4500	7,9	NU 416 M
85	130	22	68,2	86,5	6000	9000	1,1	NJ 1017 M
85	130	22	68,2	86,5	6000	6000	1,05	NU 1017 M
85	150	28	190	200	4800	5300	1,9	N 217 M
85	150	28	190	200	4800	5300	1,9	N 217 T
85	150	28	190	200	4800	5300	1,95	NJ 217 W
85	150	28	190	200	4800	5300	2,15	NJ 217 M
85	150	28	190	200	4800	5300	1,95	NJ 217 T
85	150	28	190	200	4800	5300	1,95	NU 217 W
85	150	28	190	200	4800	5300	2,05	NU 217 M
85	150	28	190	200	4800	5300	1,9	NU 217 T
85	150	28	190	200	4800	5300	2	NUP 217 W
85	150	28	190	200	4800	8000	2	NUP 217 M
85	150	28	190	200	4800	5300	2	NUP 217 T
85	150	36	250	280	4800	5300	2,55	NJ 2217 W
85	150	36	250	280	4800	5300	2,55	NJ 2217 M
85	150	36	250	280	4800	5300	2,55	NJ 2217 T
85	150	36	250	280	4800	5300	2,45	NU 2217 W
85	150	36	250	280	4800	5300	2,45	NU 2217 M
85	150	36	250	280	4800	5300	2,45	NU 2217 T
85	150	36	250	280	4800	8000	2,65	NUP 2217 M
85	150	36	250	280	4800	5300	2,65	NUP 2217 T
85	180	41	340	335	4000	4800	5,1	N 317 M
85	180	41	340	335	4000	4800	4,7	N 317 T
85	180	41	340	335	4000	4800	4,8	NJ 317 W
85	180	41	340	335	4000	4800	5,2	NJ 317 M
85	180	41	340	335	4000	4800	4,8	NJ 317 T
85	180	41	340	335	4000	4800	4,7	NU 317 W
85	180	41	340	335	4000	4800	5,1	NU 317 M
85	180	41	340	335	4000	4800	4,7	NU 317 T
85	180	41	340	335	4000	4800	4,9	NUP 317 W
85	180	41	340	335	4000	4800	4,9	NUP 317 M
85	180	41	340	335	4000	4800	4,9	NUP 317 T
85	180	60	455	490	4000	4800	7	NJ 2317 M
85	180	60	455	490	4000	4800	7	NJ 2317 T
85	180	60	455	490	4000	4800	6,85	NU 2317 W
85	180	60	455	490	4000	4800	6,85	NU 2317 M
85	180	60	455	490	4000	4800	6,85	NU 2317 T
85	180	60	455	490	4000	7000	7	NUP 2317 M



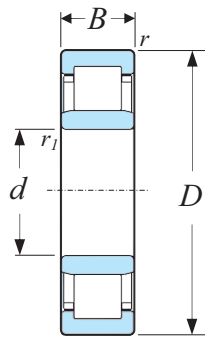

## CYLINDRICAL ROLLER BEARINGS

### Single Row

 Table 61  
 Bore Diameter 85mm - 90mm

Principal Dimension			Basic Load Ratings		Speed Ratings		Mass	Designations
d	D	B	Dynamic	Static	Ref. Speed	Limiting Speed		
mm			C	C <sub>0</sub>	r/min		kg	CT
85	180	60	455	490	4000	4800	7	NUP 2317 T
85	210	52	319	335	3600	4300	8,9	NJ 417
85	210	52	319	335	3600	4300	8,9	NJ 417 M
85	210	52	319	335	3600	4300	9,7	NU 417
85	210	52	319	335	3600	4300	9,7	NU 417 M
90	140	24	80,9	104	5600	8500	1,35	NU 1018 M
90	160	30	208	220	4500	5000	2,35	N 218 M
90	160	30	208	220	4500	5000	2,35	N 218 T
90	160	30	208	220	4500	5000	2,4	NJ 218 W
90	160	30	208	220	4500	5000	2,6	NJ 218 M
90	160	30	208	220	4500	5000	2,4	NJ 218 T
90	160	30	208	220	4500	5000	2,35	NU 218 W
90	160	30	208	220	4500	5000	2,55	NU 218 M
90	160	30	208	220	4500	5000	2,35	NU 218 T
90	160	30	208	220	4500	5000	2,45	NUP 218 M
90	160	30	208	220	4500	5000	2,45	NUP 218 T
90	160	40	280	315	4500	5000	3,2	NJ 2218 W
90	160	40	280	315	4500	5000	3,5	NJ 2218 M
90	160	40	280	315	4500	7500	3,5	NJ 2218 M
90	160	40	280	315	4500	5000	3,2	NJ 2218 T
90	160	40	280	315	4500	5000	3,15	NU 2218 W
90	160	40	280	315	4500	5000	3,15	NU 2218 M
90	160	40	280	315	4500	5000	3,15	NU 2218 T
90	160	40	280	315	4500	5000	3,3	NUP 2218 T
90	190	43	365	360	3800	4500	5,85	N 318 M
90	190	43	365	360	3800	4500	5,4	N 318 T
90	190	43	365	360	3800	4500	6	NJ 318 M
90	190	43	365	360	3800	4500	5,55	NJ 318 T
90	190	43	365	360	3800	4500	5,45	NU 318 W
90	190	43	365	360	3800	4500	5,9	NU 318 M
90	190	43	365	360	3800	4500	5,45	NU 318 T
90	190	43	365	360	3800	4500	5,65	NUP 318 W
90	190	43	365	360	3800	6700	5,65	NUP 318 M
90	190	53	365	360	3800	4500	5,55	NJ 318 W
90	190	64	500	540	3800	4500	8,15	NJ 2318 W
90	190	64	500	540	3800	4500	8,15	NJ 2318 M
90	190	64	500	540	3800	4500	8,15	NJ 2318 T
90	190	64	500	540	3800	4500	8	NU 2318 W
90	190	64	500	540	3800	4500	8	NU 2318 M

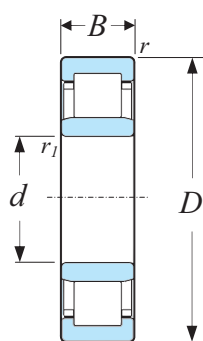

## CYLINDRICAL ROLLER BEARINGS

### Single Row

 Table 62  
 Bore Diameter 90mm - 100mm

Principal Dimension			Basic Load Ratings		Speed Ratings		Mass	Designations
d	D	B	Dynamic Static		Ref. Speed	Limiting Speed		
mm			C	C <sub>0</sub>	r/min		kg	CT
			kN					
90	190	64	500	540	3800	4500	8	NU 2318 T
90	190	64	500	540	3800	6700	8,15	NUP 2318 M
90	190	64	500	540	3800	4500	8,15	NUP 2318 T
90	225	54	380	415	3400	4000	10,5	NU 418
90	225	54	380	415	3400	4000	11,5	NU 418 M
95	145	24	84,2	110	5300	8000	1,4	NU 1019 M
95	170	32	255	265	4300	4800	2,85	N 219 T
95	170	32	255	265	4300	4800	2,9	NJ 219 W
95	170	32	255	265	4300	4800	2,9	NJ 219 M
95	170	32	255	265	4300	4800	2,9	NJ 219 T
95	170	32	255	265	4300	4800	2,85	NU 219 W
95	170	32	255	265	4300	4800	3,1	NU 219 M
95	170	32	255	265	4300	4800	2,85	NU 219 T
95	170	32	255	265	4300	4800	3	NUP 219 M
95	170	32	255	265	4300	4800	3	NUP 219 T
95	170	43	325	375	4300	4800	3,95	NJ 2219 W
95	170	43	325	375	4300	4800	3,95	NJ 2219 M
95	170	43	325	375	4300	4800	3,95	NJ 2219 T
95	170	43	325	375	4300	4800	3,85	NU 2219 W
95	170	43	325	375	4300	4800	3,85	NU 2219 M
95	170	43	325	375	4300	4800	3,85	NU 2219 T
95	170	43	325	375	4300	4800	4	NUP 2219 T
95	200	45	390	390	3600	4300	6,25	N 319 M
95	200	45	390	390	3600	4300	6,25	N 319 T
95	200	45	390	390	3600	4300	6,45	NJ 319 W
95	200	45	390	390	3600	4300	7,5	NJ 319 M
95	200	45	390	390	3600	4300	6,45	NJ 319 T
95	200	45	390	390	3600	4300	6,25	NU 319 W
95	200	45	390	390	3600	4300	7,3	NU 319 M
95	200	45	390	390	3600	4300	6,25	NU 319 T
95	200	45	390	390	3600	4300	7,3	NUP 319 M
95	200	45	390	390	3600	4300	6,25	NUP 319 T
95	200	67	530	585	3600	4300	10,7	NJ 2319 W
95	200	67	530	585	3600	6300	10,7	NJ 2319 M
95	200	67	530	585	3600	4300	10,7	NJ 2319 T
95	200	67	530	585	3600	4300	9,65	NU 2319 W
95	200	67	530	585	3600	6300	10,5	NU 2319 M
95	200	67	530	585	3600	4300	9,65	NU 2319 T
95	200	67	530	585	3600	4300	9,75	NUP 2319 W
95	200	67	530	585	3600	6300	9,75	NUP 2319 M
95	200	67	530	585	3600	4300	9,75	NUP 2319 T
95	240	55	413	455	3200	3600	13,5	NU 419 M
100	150	24	85,8	114	5000	5000	1,45	NU 1020 M

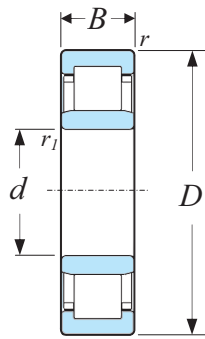

## CYLINDRICAL ROLLER BEARINGS

### Single Row

 Table 63  
 Bore Diameter 100mm

Principal Dimension			Basic Load Ratings		Speed Ratings		Mass	Designations
d	D	B	Dynamic Static		Ref. Speed	Limiting Speed		
mm			C	C <sub>0</sub>	r/min		kg	CT
100	150	24	85,8	114	5000	7500	1,45	NU 1020 M
100	180	34	285	305	4000	4500	3,45	N 220 T
100	180	34	285	305	4000	4500	3,55	NJ 220 W
100	180	34	285	305	4000	4500	3,8	NJ 220 M
100	180	34	285	305	4000	4500	3,5	NJ 220 T
100	180	34	285	305	4000	4500	3,45	NU 220 W
100	180	34	285	305	4000	4500	3,75	NU 220 M
100	180	34	285	305	4000	4500	3,45	NU 220 T
100	180	34	285	305	4000	6700	3,6	NUP 220 M
100	180	34	285	305	4000	4500	3,6	NUP 220 T
100	180	46	380	450	4000	4500	4,8	NJ 2220 W
100	180	46	380	450	4000	4500	5,2	NJ 2220 M
100	180	46	380	450	4000	4500	4,8	NJ 2220 T
100	180	46	380	450	4000	4500	4,75	NU 2220 W
100	180	46	380	450	4000	4500	4,75	NU 2220 M
100	180	46	380	450	4000	6700	5,15	NU 2220 M
100	180	46	380	450	4000	4500	4,75	NU 2220 T
100	180	46	380	450	4000	6700	4,9	NUP 2220 M
100	180	46	380	450	4000	4500	4,9	NUP 2220 T
100	215	47	450	440	3200	3800	8,85	N 320 M
100	215	47	450	440	3200	3800	7,55	N 320 T
100	215	47	450	440	3200	3800	9	NF 320 M
100	215	47	450	440	3200	3800	7,8	NJ 320 W
100	215	47	450	440	3200	3800	9	NJ 320 M
100	215	47	450	440	3200	3800	7,65	NJ 320 T
100	215	47	450	440	3200	3800	7,85	NU 320 W
100	215	47	450	440	3200	3800	8,95	NU 320 M
100	215	47	450	440	3200	3800	7,8	NU 320 T
100	215	47	450	440	3200	3800	8	NUP 320 W
100	215	47	450	440	3200	6000	9	NUP 320 M
100	215	73	670	735	3200	3800	12,2	NJ 2320 W
100	215	73	670	735	3200	3800	13,2	NJ 2320 M
100	215	73	670	735	3200	3800	12,2	NJ 2320 T
100	215	73	670	735	3200	3800	12	NU 2320 W
100	215	73	670	735	3200	3800	13	NU 2320 M
100	215	73	670	735	3200	6000	13	NU 2320 M
100	215	73	670	735	3200	3800	12	NU 2320 T
100	215	73	670	735	3200	3800	12,5	NUP 2320 W
100	215	73	670	735	3200	6000	12,5	NUP 2320 M
100	215	73	670	735	3200	3800	12,5	NUP 2320 T
100	250	58	429	475	3000	3600	14	NU 420

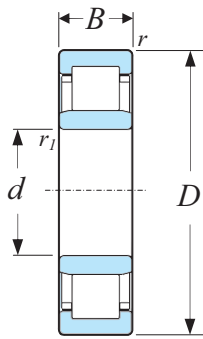

CYLINDRICAL ROLLER BEARINGS  
Single Row

Table 64  
Bore Diameter 100mm

Principal Dimension			Basic Load Ratings		Speed Ratings		Mass	Designations
d	D	B	Dynamic	Static	Ref. Speed	Limiting Speed		
mm			C	C <sub>0</sub>	r/min		kg	CT
100	150	24	85,8	114	5000	7500	1,45	NU 1020 M
100	250	58	429	475	3000	3600	14	NU 420 M

## TAPERED ROLLER BEARINGS

Tapered roller bearings are designed to particularly accommodate combined loads, which are radial and axial loads simultaneously. The inner and outer rings of tapered roller bearings are both tapered where the conical rollers are arranged. The axial projection lines of these conical rollers are meeting at a common point of the bearing axis. The greater the angle ( $\alpha$ ) of these projection lines comes with the greater capability of the bearings to carry axial loads. Tapered roller bearings are generally separable, the cone which consisting of the conical rollers and cage assemblies can be mounted separately from the outer ring.

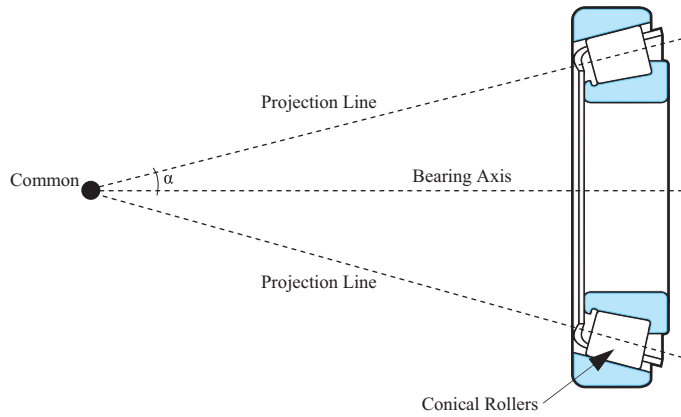

### Single Row Tapered Roller Bearings

Single row tapered roller bearings has one row of conical rollers guided in the tapered raceway at a certain angle. They support high combination of simultaneous radial and axial loads. However, single row tapered roller bearings are able to carry axial load in one direction only.

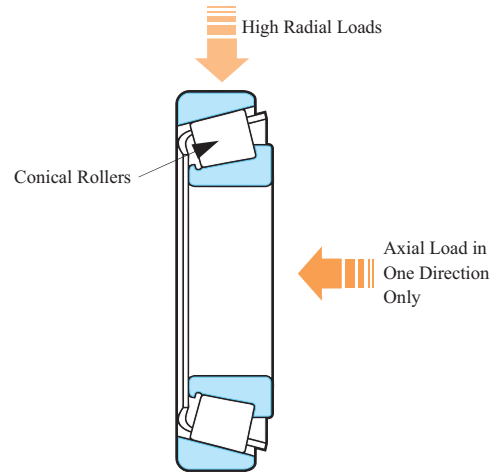

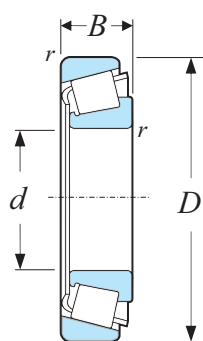

## TAPERED ROLLER BEARINGS Single Row

Table 65  
Bore Diameter 15mm - 40mm

Principal Dimension			Basic Load Ratings		Speed Ratings		Mass	Designations
d	D	B	Dynamic Static		Ref. Speed	Limiting Speed		
mm			C	C <sub>0</sub>	r/min		kg	CT
15	42	14,25	22,4	20	13000	18000	0,095	30302 J
17	40	13,25	19	18,6	13000	18000	0,075	30203 J
17	47	15,25	28,1	25	12000	16000	0,13	30303 J
17	47	20,25	34,7	33,5	11000	16000	0,17	32303 J
20	42	15	24,2	27	12000	16000	0,097	32004 J
20	47	15,25	27,5	28	11000	15000	0,12	30204 J
20	52	16,25	34,1	32,5	11000	14000	0,17	30304 J
20	52	22,25	44	45,5	10000	14000	0,23	32304 J
22	44	15	25,1	29	11000	15000	0,1	320/22 J
25	47	15	27	32,5	11000	14000	0,11	32005 J
25	52	16,25	30,8	33,5	10000	13000	0,15	30205 J
25	52	19,25	35,8	44	9500	13000	0,19	32205 J
25	52	22	47,3	56	10000	13000	0,23	33205 J
25	62	18,25	44,6	43	9000	12000	0,26	30305 J
25	62	18,25	38	40	7500	11000	0,26	31305 J
25	62	25,25	60,5	63	8000	12000	0,36	32305 J
28	52	16	31,9	38	10000	13000	0,15	320/28 J
28	58	17,25	38	41,5	9000	12000	0,25	302/28 J
28	58	20,25	41,8	50	8500	12000	0,25	322/28 J
30	55	17	35,8	44	9000	12000	0,17	32006 J
30	62	17,25	40,2	44	8500	11000	0,23	30206 J
30	62	21,25	49,5	58,5	8000	11000	0,3	32206 J
30	62	25	64,4	76,5	7500	11000	0,37	33206 J
30	72	20,75	56,1	56	7500	10000	0,39	30306 J
30	72	20,75	47,3	50	6700	9500	0,39	31306 J
30	72	28,75	76,5	85	7000	10000	0,55	32306 J
32	58	17	36,9	46,5	8500	11000	0,19	320/32 J
35	62	18	37,4	49	8000	11000	0,22	32007 J
35	72	18,25	51,2	56	7000	9500	0,32	30207 J
35	72	24,25	66	78	7000	9500	0,43	32207 J
35	72	28	84,2	106	6300	9500	0,56	33207 J
35	80	22,75	72,1	73,5	6700	9000	0,52	30307 J
35	80	22,75	72,1	73,5	6700	9000	0,52	30307 J
35	80	22,75	61,6	67	6000	8500	0,52	31307 J
35	80	32,75	93,5	114	6000	8500	0,8	32307 J
37	80	32,75	93,5	114	6000	8500	0,8	32307/37 J
38	68	19	52,8	71	7000	9500	0,27	32008/38 J
40	68	19	52,8	71	7000	9500	0,27	32008 J
40	75	26	79,2	104	6700	9000	0,51	33108 J
40	80	19,75	61,6	68	6300	8500	0,42	30208 J
40	80	24,75	78,8	86,5	6300	8500	0,53	32208 J
40	80	32	105	132	5600	8500	0,77	33208 J
40	90	25,25	85,8	95	6000	8000	0,72	30308 J
40	90	25,25	85	81,5	5600	7500	0,72	31308 J

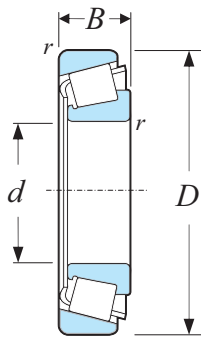

## TAPERED ROLLER BEARINGS

### Single Row

Table 66  
Bore Diameter 40mm - 65mm

Principal Dimension			Basic Load Ratings		Speed Ratings		Mass	Designations
d	D	B	Dynamic Static		Ref. Speed	Limiting Speed		
mm			C	C <sub>0</sub>	r/min		kg	CT
40	90	35,25	117	140	5300	8000	1	32308 J
45	75	20	58,3	80	6300	8500	0,34	32009 J
45	80	26	96,5	114	6700	8000	0,56	33109 J
45	85	20,75	66	76,5	6000	8000	0,48	30209 J
45	85	24,75	91,5	98	6300	8000	0,58	32209 J
45	85	32	108	143	5300	7500	0,82	33209 J
45	90	24,75	82,5	104	5300	8000	0,65	32210/45 J
45	100	27,25	108	120	5300	7000	0,97	30309 J
45	100	27,25	106	102	5000	6700	0,95	31309 J
45	100	38,25	134	176	4800	6700	1,45	32309 J
45	100	38,25	140	170	4800	7000	1,35	32309 J
50	80	20	60,5	88	6000	8000	0,37	32010 J
50	80	24	69,3	102	6000	8000	0,45	33010 J
50	85	26	85,8	122	5600	7500	0,59	33110 J
50	90	21,75	76,5	91,5	5600	7500	0,54	30210 J
50	90	24,75	82,5	100	5600	7500	0,61	32210 J
50	90	32	114	160	5000	7000	0,9	33210 J
50	110	29,25	143	140	5300	6300	1,25	30310 J
50	110	29,25	122	120	4500	6000	1,2	31310 J
50	110	42,25	172	212	4300	6300	1,8	32310 T
55	90	23	80,9	116	5300	7000	0,55	32011 J
55	90	27	104	137	5600	7000	0,67	33011 J
55	95	30	110	156	5000	6700	0,86	33111 J
55	100	22,75	104	106	5300	6700	0,7	30211 J
55	100	26,75	106	129	5000	6700	0,83	32211 J
55	100	35	138	190	4500	6300	1,2	33211 J
55	120	31,5	166	163	4800	5600	1,55	30311 J
55	120	31,5	121	137	3800	5600	1,55	31311 J
55	120	45,5	216	260	4300	5600	2,5	32311 J
55	120	45,5	198	250	4000	5600	2,3	32311 J
60	95	23	95	122	5300	6700	0,59	32012 J
60	95	27	106	143	5300	6700	0,71	33012 J
60	100	30	117	170	4800	6300	0,92	33112 J
60	110	23,75	112	114	5000	6000	0,88	30212 J
60	110	29,75	125	160	4500	6000	1,15	32212 J
60	110	38	168	236	4000	6000	1,6	33212 J
60	130	33,5	168	196	4000	5300	1,95	30312 J
60	130	33,5	145	166	3600	5300	1,9	31312 J
60	130	48,5	220	305	3600	5000	2,8	32312 J
65	100	23	96,5	127	5000	6000	0,63	32013 J
65	100	27	110	153	5000	6300	0,78	33013 J
65	110	34	142	208	4300	5600	1,3	33113 J
65	120	24,75	132	134	4500	5600	1,15	30213 J

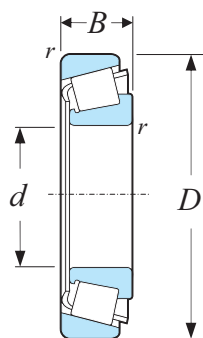

## TAPERED ROLLER BEARINGS Single Row

Table 67  
Bore Diameter 65mm - 90mm

Principal Dimension			Basic Load Ratings		Speed Ratings		Mass	Designations
d	D	B	Dynamic Static		Ref. Speed	Limiting Speed		
mm			C	C <sub>0</sub>	r/min		kg	CT
65	120	32,75	151	193	4000	5600	1,5	32213 J
65	120	41	194	270	3800	5300	2,05	33213 J
65	140	36	194	228	3600	4800	2,4	30313 J
65	140	36	194	228	3600	4800	2,4	30313 J
65	140	36	165	193	3200	4800	2,35	31313 J
65	140	51	246	345	3200	4800	3,35	32313 J
70	110	25	101	153	4300	5600	0,84	32014 J
70	110	31	130	196	4300	5600	1,1	33014 J
70	120	37	172	250	4000	5300	1,7	33114 J
70	125	26,25	125	156	4000	5300	1,25	30214 J
70	125	33,25	157	208	3800	5300	1,6	32214 J
70	125	41	201	285	3600	5000	2,1	33214 J
70	150	38	220	260	3400	4500	2,9	30314 J
70	150	38	187	220	3000	4500	2,95	31314 J
70	150	54	281	400	3000	4300	4,25	32314 J
75	105	20	70,4	116	4300	6300	0,52	32915 T
75	115	25	106	163	4000	5300	0,9	32015 J
75	115	31	134	228	4000	5300	1,15	33015 J
75	125	37	176	265	3800	5000	1,8	33115 J
75	130	27,25	140	176	3800	5000	1,4	30215 J
75	130	33,25	161	212	3600	5000	1,7	32215 J
75	130	41	209	300	3400	4800	2,25	33215 J
75	160	40	246	290	3200	4300	3,45	30315 J
75	160	40	209	245	2800	4300	3,5	31315 J
75	160	58	336	440	3000	4300	5,2	32315 J
80	125	29	138	216	3600	5000	1,3	32016 J
80	125	36	168	285	3600	5000	1,65	33016 J
80	130	37	179	280	3600	4800	1,9	33116 J
80	140	28,25	151	183	3400	4800	1,6	30216 J
80	140	35,25	187	245	3400	4500	2,05	32216 J
80	140	46	251	375	3200	4500	2,9	33216 J
80	170	42,5	270	320	3000	4300	4,1	30316 J
80	170	42,5	224	265	2800	4000	4,05	31316 J
80	170	61,5	380	500	3000	4300	6,2	32316 J
85	130	29	140	224	3400	4800	1,35	32017 J
85	140	41	220	340	3400	4500	2,45	33117 J
85	150	30,5	176	220	3200	4300	2,05	30217 J
85	150	38,5	212	285	3200	4300	2,6	32217 J
85	150	49	286	430	3000	4300	3,7	33217 J
85	180	44,5	303	365	2800	4000	4,85	30317 J
85	180	44,5	242	285	2600	3800	4,6	31317 J
85	180	63,5	391	560	2800	4000	7,5	32317 J
90	140	32	168	270	3200	4300	1,75	32018 J



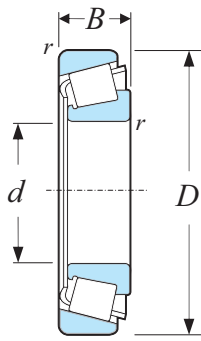

## TAPERED ROLLER BEARINGS

### Single Row

Table 68  
Bore Diameter 90mm - 130mm

Principal Dimension			Basic Load Ratings		Speed Ratings		Mass	Designations
d	D	B	Dynamic Static		Ref. Speed	Limiting Speed		
mm			C	C <sub>0</sub>	r/min		kg	CT
90	150	45	251	390	3000	4300	3,1	33118 J
90	160	32,5	194	245	3000	4000	2,55	30218 J
90	160	42,5	251	340	3000	4000	3,35	32218 J
90	190	46,5	330	400	2600	4000	5,65	30318 J
90	190	46,5	264	315	2400	3400	5,9	31318 J
90	190	67,5	457	610	2600	4000	8,4	32318 J
95	145	32	168	270	3200	4300	1,8	32019 J
95	145	39	220	375	3200	4300	2,3	33019 J
95	170	34,5	216	275	2800	3800	3	30219 J
95	170	45,5	281	390	2800	3800	4,05	32219 J
95	200	49,5	330	390	2600	3400	6,7	30319
95	200	49,5	292	355	2400	3400	6,95	31319 J
95	200	71,5	501	670	2400	3400	11	32319 J
100	140	25	119	204	3200	4800	1,15	32920 J
100	150	32	172	280	3000	4000	1,9	32020 J
100	150	39	224	390	3000	4000	2,4	33020 J
100	180	37	246	320	2800	3600	3,65	30220 J
100	180	49	319	440	2600	3600	4,9	32220 J
100	180	63	429	655	2400	3600	6,95	33220
100	215	51,5	402	490	2400	3200	8,05	30320 J
100	215	56,5	374	465	2200	3000	8,6	31320 J
100	215	77,5	572	780	2200	3000	12,5	32320 J
105	160	35	201	335	2800	3800	2,4	32021 J
105	160	43	246	430	2800	3800	3,05	33021 J
105	190	39	270	355	2600	3400	4,25	30221 J
105	190	53	358	510	2600	3400	6	32221 J
105	225	81,5	605	815	2000	3000	14,5	32321 J
110	150	25	125	224	3000	4300	1,25	32922 J
110	170	38	233	390	2600	3600	3,05	32022 J
110	170	47	281	500	2600	3600	3,85	33022
110	180	56	369	630	2600	3400	5,55	33122
110	200	41	308	405	2400	3200	5,1	30222 J
110	200	56	402	570	2400	3200	7,1	32222 J
110	240	54,5	473	585	2200	2800	11	30322 J
110	240	63	457	585	1900	2800	12	31322 J
110	240	84,5	627	830	1900	2800	17	32322
120	165	29	165	305	2600	3800	1,8	32924
120	180	38	242	415	2400	3400	3,25	32024 J
120	180	48	292	540	2600	3400	4,2	33024
120	215	43,5	341	465	2200	3000	6,15	30224 J
120	215	61,5	468	695	2200	3000	9,15	32224 J
120	260	59,5	561	710	2000	2600	14	30324 J
120	260	68	539	695	1700	2400	15,5	31324 J
120	260	90,5	792	1120	1800	2600	21,5	32324 J
130	180	32	198	365	2400	3600	2,4	32926
130	200	45	314	540	2200	3000	4,95	32026 J
130	230	43,75	369	490	2000	2800	7,6	30226 J
130	230	67,75	550	830	2000	2800	11,5	32226 J

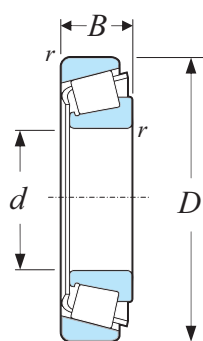

## TAPERED ROLLER BEARINGS Single Row

Table 69  
Bore Diameter 130mm - 200mm

Principal Dimension			Basic Load Ratings		Speed Ratings		Mass	Designations
d	D	B	Dynamic	Static	Ref. Speed	Limiting Speed		
mm			C	C <sub>0</sub>	r/min		kg	CT
130	280	63,75	627	800	1800	2400	17	30326 J
130	280	72	605	780	1600	2400	18,5	31326 J
140	190	32	205	390	2200	3400	2,55	32928
140	210	45	330	585	2200	2800	5,25	32028 J
140	250	45,75	418	570	1900	2600	8,65	30228 J
140	250	71,75	644	1000	1900	2600	14,5	32228 J
140	300	77	693	900	1500	2200	24,5	31328 J
150	225	48	369	655	2000	2600	6,35	32030 J
150	225	59	457	865	2000	2600	8,15	33030
150	270	49	429	560	1800	2400	11	30230
150	270	77	737	1140	1700	2400	17,5	32230 J
150	320	82	781	1020	1400	2000	29,5	31330 J
160	240	51	429	780	1800	2400	7,75	32032 J
160	290	52	528	735	1600	2200	13	30232 J
160	290	84	880	1400	1600	2200	25,5	32232 J
160	340	75	913	1180	1500	2000	29	30332 J
170	230	38	286	585	1900	2800	4,5	32934
170	260	57	512	915	1700	2200	10,5	32034 J
170	310	57	616	865	1500	2000	19	30234 J
170	310	91	1010	1630	1500	2000	28,5	32234 J
180	250	45	352	735	1700	2600	6,65	32936
180	280	64	644	1160	1600	2200	14,5	32036 J
180	320	57	583	815	1500	2000	20	30236 J
180	320	91	1010	1630	1400	1900	29,5	32236 J
190	260	45	358	765	1600	2400	7	32938
190	290	64	660	1200	1500	2000	15	32038 J
190	340	60	721	1000	1400	1800	24	30238 J
200	280	51	473	950	1500	2200	9,5	32940
200	310	70	748	1370	1400	1900	19,5	32040 J
200	360	64	792	1120	1300	1700	25	30240 J
200	360	104	1210	2000	1300	1700	42,5	32240 J

## NEEDLE ROLLER BEARINGS

The rolling elements of needle roller bearings are basically cylindrical rollers, but they are long and thin relatively to their diameter. The needle roller bearing has low cross section, but possessing high load carrying capacity, and therefore they are particularly suitable in applications where there is constraint of radial installation space. Needle roller bearings are presents in many designs and sizes, such as needle roller and cage assemblies, drawn cup needle roller bearings, as well as cam rollers and cam followers are also categorized as needle roller bearings.

### Needle Rollers and Cage Assemblies

The cage of the needle rollers and cage assemblies is acting an important role for the bearings to operate at high speed, in addition to high load carrying capacity. There are neither inner rings nor outer rings, the cage holds the needle rollers, with its' low cross section that provides the maximum load carrying capacity, and within the smallest radial space among all types of bearings. The cage is uniquely designed to precisely hold the needle rollers to possibly reduce stresses of bearing during operations, and allowing moderate shaft misalignment so that to extend the bearings life span.

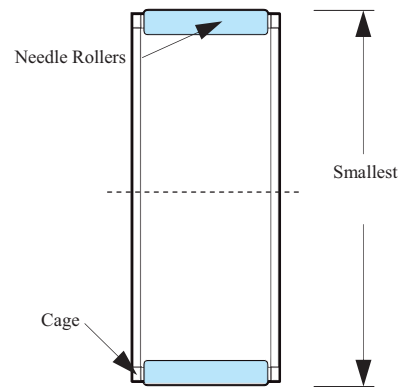

### Drawn Cup Needle Roller Bearings

Drawn cup needle roller bearings has very uniquely designed thin walled outer ring structures, with either open or closed end. The drawn cup is the thinnest outer rings among all types of rolling bearings. In spite of its' thin outer rings, drawn cup needle roller bearings has capability of carrying high radial loads. The bearings' unique characteristics are suitable for application where the housing bore cannot be used as raceway for needle roller and cage assemblies, but requiring a very compact bearing arrangement.

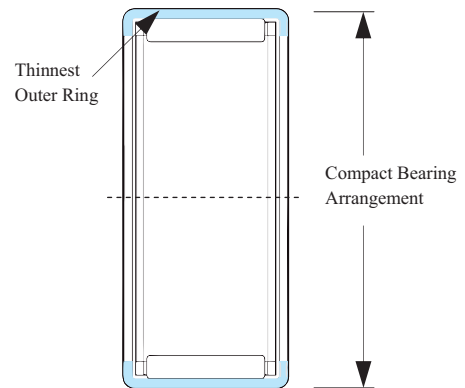

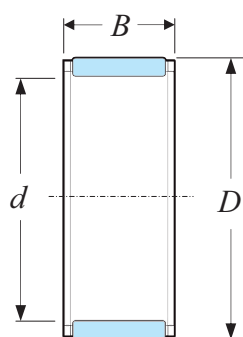

## NEEDLE ROLLER BEARINGS

### Needle Roller & Cage Assemblies

Table 70  
Diameter 3mm - 17mm

Principal Dimension			Basic Load Ratings		Speed Ratings		Mass	Designations
d	D	B	Dynamic Static		Ref. Speed	Limiting Speed	kg	CT
mm			C	C <sub>0</sub>	r/min			
3	5	7	1,51	1,34	40000	45000	0,0003	K3X5X7-TV
3	5	9	1,72	1,63	38000	43000	0,0004	K3X5X9-TV
3	6	7	1,42	1,02	38000	43000	0,0004	K3X6X7-TV
4	7	7	1,72	1,32	36000	43000	0,0005	K4X7X7-TV
4	7	10	2,29	1,9	36000	43000	0,0007	K4X7X10-TV
5	8	8	2,29	2	36000	40000	0,0007	K5X8X8-TV
5	8	10	2,92	2,7	36000	40000	0,0009	K5X8X10-TV
6	9	8	2,55	2,36	34000	38000	0,0008	K6X9X8-TV
6	9	10	3,3	3,2	34000	38000	0,0011	K6X9X10-TV
6	10	13	3,69	3,15	34000	38000	0,0019	K6X10X13-TV
7	9	7	1,68	1,83	34000	38000	0,0006	K7X9X7-TV
7	10	8	2,81	2,75	32000	36000	0,0009	K7X10X8-TV
7	10	10	3,58	3,75	32000	36000	0,001	K7X10X10-TV
8	11	8	3,03	3,1	32000	36000	0,001	K8X11X8-TV
8	11	10	3,8	4,25	32000	36000	0,0012	K8X11X10-TV
8	11	13	5,01	5,85	32000	36000	0,0017	K8X11X13-TV
8	12	10	4,84	4,75	30000	34000	0,002	K8X12X10-TV
9	12	10	4,4	5,2	30000	34000	0,0015	K9X12X10-TV
9	12	13	5,72	7,2	30000	34000	0,0021	K9X12X13-TV
10	13	10	4,57	5,7	28000	32000	0,0016	K10X13X10-TV
10	13	13	5,94	8	28000	32000	0,0023	K10X13X13-TV
10	13	16	6,82	9,5	28000	32000	0,0029	K10X13X16-TV
10	14	10	5,61	6,1	28000	32000	0,0025	K10X14X10-TV
10	14	13	5,83	6,3	28000	32000	0,0046	K10X14X13-TV
10	16	12	7,65	7,2	28000	32000	0,0055	K10X16X12-TV
12	15	10	4,73	6,2	26000	30000	0,0019	K12X15X10-TV
12	15	13	6,16	8,65	26000	30000	0,0023	K12X15X13-TV
12	16	13	7,65	9,5	26000	30000	0,0036	K12X16X13-TV
12	17	13	9,13	10,4	26000	30000	0,0049	K12X17X13-TV
12	18	12	9,52	10	26000	30000	0,006	K12X18X12-TV
14	18	10	6,93	8,65	24000	28000	0,004	K14X18X10
14	18	13	7,92	10,2	24000	28000	0,0065	K14X18X13
14	18	15	9,13	12,5	24000	28000	0,005	K14X18X15-TV
14	18	17	10,5	14,6	24000	28000	0,008	K14X18X17
14	20	12	9,9	10,6	24000	28000	0,0085	K14X20X12
15	18	17	7,65	12,2	24000	28000	0,0046	K15X18X17-TV
15	19	10	7,21	9,3	24000	28000	0,005	K15X19X10
15	19	13	8,25	11,2	24000	28000	0,007	K15X19X13
15	19	17	10,8	15,6	24000	28000	0,0095	K15X19X17
15	20	13	9,52	11,6	24000	26000	0,007	K15X20X13
15	21	15	13,8	16,3	24000	26000	0,011	K15X21X15
15	21	21	18,7	24,5	24000	26000	0,017	K15X21X21
16	20	10	7,48	10	24000	26000	0,0055	K16X20X10
16	20	13	8,58	12	24000	26000	0,0075	K16X20X13
16	20	17	11,2	17	24000	26000	0,01	K16X20X17
16	22	12	11	12,5	22000	26000	0,01	K16X22X12
16	22	16	14,2	17,6	22000	26000	0,012	K16X22X16
16	22	20	17,6	22,8	22000	26000	0,017	K16X22X20
16	24	20	20,5	23,6	22000	24000	0,022	K16X24X20
17	21	10	7,81	10,8	22000	26000	0,0055	K17X21X10

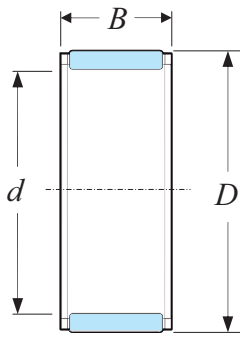

## NEEDLE ROLLER BEARINGS

### Needle Roller & Cage Assemblies

Table 71  
Diameter 17mm - 26mm

Principal Dimension			Basic Load Ratings		Speed Ratings		Mass	Designations
d	D	B	Dynamic Static		Ref. Speed	Limiting Speed		
mm			C	C <sub>0</sub>	r/min		kg	CT
			kN					
17	21	13	10,1	14,6	22000	26000	0,0065	K17X21X13
17	21	17	11,7	18,3	22000	26000	0,0095	K17X21X17
18	22	10	8,09	11,4	22000	24000	0,006	K18X22X10
18	22	13	8,8	12,9	22000	24000	0,008	K18X22X13
18	22	17	11,7	18,3	22000	24000	0,011	K18X22X17
18	24	12	12,1	15	20000	24000	0,012	K18X24X12
18	24	13	12,5	15,3	20000	24000	0,013	K18X24X13
18	24	20	19,4	27	20000	24000	0,018	K18X24X20
18	25	22	22	29	20000	24000	0,023	K18X25X22
19	23	13	9,13	13,7	20000	24000	0,008	K19X23X13
19	23	17	12,1	19,3	20000	24000	0,011	K19X23X17
20	24	10	8,58	12,9	20000	22000	0,0065	K20X24X10
20	24	13	9,52	14,6	20000	22000	0,009	K20X24X13
20	24	17	12,5	20,8	20000	22000	0,012	K20X24X17
20	26	12	12,8	16,3	19000	22000	0,011	K20X26X12
20	26	13	13,8	18	19000	22000	0,012	K20X26X13
20	26	17	18,3	26	19000	22000	0,016	K20X26X17
20	26	20	20,1	29	19000	22000	0,019	K20X26X20
20	28	16	19	22,4	18000	20000	0,02	K20X28X16
20	28	20	22,9	28,5	18000	20000	0,027	K20X28X20
20	28	25	29,2	39	18000	20000	0,032	K20X28X25
20	30	30	34,1	41,5	17000	20000	0,049	K20X30X30
21	25	13	9,68	15,3	19000	22000	0,009	K21X25X13
22	26	10	8,8	13,7	18000	20000	0,0075	K22X26X10
22	26	13	10,1	16,3	18000	20000	0,0095	K22X26X13
22	26	17	13,2	22,8	18000	20000	0,012	K22X26X17
22	28	17	18,3	27	17000	20000	0,018	K22X28X17
22	29	16	19,4	25,5	17000	19000	0,016	K22X29X16
22	30	15	19	23,6	17000	19000	0,018	K22X30X15-TV
22	32	24	31,9	40	16000	18000	0,043	K22X32X24
23	35	16	24,2	23,2	15000	17000	0,029	K23X35X16-TV
24	28	10	9,35	15	17000	19000	0,0085	K24X28X10
24	28	13	10,6	18	17000	19000	0,01	K24X28X13
24	28	17	14	25,5	17000	19000	0,013	K24X28X17
24	30	17	18,7	27,5	16000	18000	0,019	K24X30X17
25	29	10	9,52	15,6	16000	18000	0,0085	K25X29X10
25	29	13	10,8	18,6	16000	18000	0,011	K25X29X13
25	29	17	14,2	26,5	16000	18000	0,014	K25X29X17
25	30	17	17,9	30,5	16000	18000	0,016	K25X30X17
25	30	20	20,9	36,5	16000	18000	0,018	K25X30X20
25	31	17	18,7	28,5	16000	18000	0,019	K25X31X17
25	31	21	23,3	38	16000	18000	0,02	K25X31X21
25	32	16	19,8	27,5	15000	17000	0,021	K25X32X16
25	33	20	27,5	38	15000	17000	0,033	K25X33X20
25	33	24	31,9	47,5	15000	17000	0,039	K25X33X24
25	35	30	44,6	62	15000	17000	0,065	K25X35X30
26	30	13	11,2	19,6	16000	18000	0,011	K26X30X13
26	30	17	14,7	27,5	16000	18000	0,015	K26X30X17

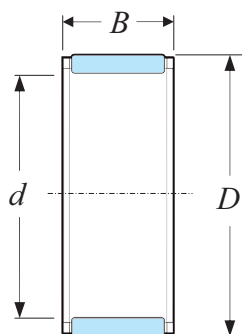

## NEEDLE ROLLER BEARINGS

### Needle Roller & Cage Assemblies

Table 72  
Diameter 26mm - 42mm

Principal Dimension			Basic Load Ratings		Speed Ratings		Mass	Designations
d	D	B	Dynamic Static		Ref. Speed	Limiting Speed	kg	CT
mm			C	C <sub>0</sub>	r/min			
28	33	13	14,7	24,5	14000	16000	0,013	K28X33X13
28	33	17	19	33,5	14000	16000	0,017	K28X33X17
28	34	17	20,9	33,5	14000	16000	0,024	K28X34X17
28	35	16	20,5	30	14000	16000	0,024	K28X35X16
28	35	18	22,9	34,5	14000	16000	0,027	K28X35X18
28	40	25	42,9	55	13000	15000	0,07	K28X40X25
30	34	13	11,9	22	14000	15000	0,014	K30X34X13
30	35	13	15,1	25,5	13000	15000	0,014	K30X35X13
30	35	17	18,7	34	13000	15000	0,019	K30X35X17
30	35	27	29,2	60	13000	15000	0,03	K30X35X27
30	37	16	22	33,5	13000	15000	0,027	K30X37X16
30	37	18	25,1	39	13000	15000	0,03	K30X37X18
30	40	18	30,3	40	12000	14000	0,048	K30X40X18
30	40	30	46,8	69,5	12000	14000	0,073	K30X40X30
32	37	13	14,7	25,5	13000	14000	0,018	K32X37X13
32	37	17	19	35,5	13000	14000	0,019	K32X37X17
32	37	27	28,6	60	13000	14000	0,03	K32X37X27
32	38	20	25,1	45	12000	14000	0,03	K32X38X20
32	39	16	22,9	35,5	12000	14000	0,037	K32X39X16
32	39	18	25,5	41,5	12000	14000	0,031	K32X39X18
32	40	25	35,8	58,5	12000	14000	0,049	K32X40X25
32	46	32	62,7	83	11000	13000	0,119	K32X46X32
35	40	13	15,4	28	12000	13000	0,019	K35X40X13
35	40	17	19,8	39	12000	13000	0,021	K35X40X17
35	40	25	28,1	60	12000	13000	0,031	K35X40X25
35	40	27	23,8	49	12000	13000	0,039	K35X40X27-TV
35	42	16	23,3	37,5	11000	13000	0,034	K35X42X16
35	42	18	26,4	44	11000	13000	0,034	K35X42X18
35	42	20	29,2	50	11000	13000	0,037	K35X42X20
35	42	30	37,4	68	11000	13000	0,067	K35X42X30
35	45	20	35,2	50	11000	12000	0,056	K35X45X20
35	45	30	50,1	80	11000	12000	0,08	K35X45X30
37	42	17	21,6	43	11000	13000	0,022	K37X42X17
38	43	17	19,8	39	11000	12000	0,029	K38X43X17
38	43	27	30,3	68	11000	12000	0,043	K38X43X27
38	46	20	34,1	57	10000	12000	0,047	K38X46X20
38	46	32	52,3	100	10000	12000	0,076	K38X46X32
40	45	13	16,8	32,5	10000	12000	0,022	K40X45X13
40	45	17	20,5	41,5	10000	12000	0,031	K40X45X17
40	45	27	31,4	73,5	10000	12000	0,046	K40X45X27
40	47	18	28,6	50	10000	11000	0,039	K40X47X18
40	47	20	31,4	57	10000	11000	0,042	K40X47X20
40	48	20	34,7	58,5	10000	11000	0,049	K40X48X20
42	47	13	17,2	33,5	10000	11000	0,018	K42X47X13
42	47	17	20,9	43	10000	11000	0,032	K42X47X17
42	50	20	31,9	54	9500	11000	0,053	K42X50X20

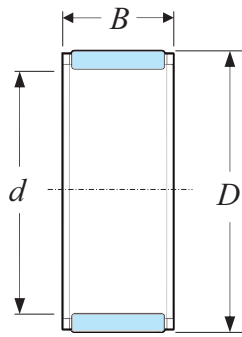

## NEEDLE ROLLER BEARINGS

### Needle Roller & Cage Assemblies

 Table 73  
 Diameter 43mm - 70mm

Principal Dimension			Basic Load Ratings		Speed Ratings		Mass	Designations
d	D	B	Dynamic Static		Ref. Speed	Limiting Speed	kg	CT
mm			C	C <sub>0</sub>	r/min			
43	48	17	20,9	43	9500	11000	0,03	K43X48X17
43	48	27	31,9	76,5	9500	11000	0,05	K43X48X27
45	50	17	21,6	46,5	9000	10000	0,034	K45X50X17
45	52	18	30,3	57	9000	10000	0,042	K45X52X18
45	53	20	37,4	68	9000	10000	0,055	K45X53X20
45	53	21	36,9	67	9000	10000	0,06	K45X53X21
45	53	28	49,5	98	9000	10000	0,081	K45X53X28
45	59	18	44	53	8500	9500	0,072	K45X59X18-TV
45	59	32	69,3	102	8500	9500	0,148	K45X59X32
47	52	17	22,4	49	9000	10000	0,035	K47X52X17
47	52	27	33,6	83	9000	10000	0,051	K47X52X27
50	55	13,5	17,6	36,5	8500	9500	0,03	K50X55X13.5
50	55	17	21,2	47,5	8500	9500	0,035	K50X55X17
50	55	20	25,5	60	8500	9500	0,043	K50X55X20
50	55	30	37,4	98	8500	9500	0,065	K50X55X30
50	57	18	31,9	64	8000	9000	0,047	K50X57X18
50	58	20	34,1	62	8000	9000	0,075	K50X58X20
50	58	25	41,8	81,5	8000	9000	0,09	K50X58X25
52	57	12	17,2	36,5	8000	9000	0,024	K52X57X12
55	60	20	27	67	7500	8500	0,04	K55X60X20
55	60	27	35,8	96,5	7500	8500	0,06	K55X60X27
55	60	30	39,6	108	7500	8500	0,071	K55X60X30
55	62	18	34,1	71	7500	8500	0,052	K55X62X18
55	63	20	38	75	7500	8500	0,067	K55X63X20
55	63	25	48,4	102	7500	8500	0,08	K55X63X25
55	63	32	59,4	129	7500	8500	0,1	K55X63X32
58	65	18	33,6	71	7000	8000	0,052	K58X65X18
60	65	20	28,1	72	7000	8000	0,052	K60X65X20
60	65	30	41,3	116	7000	8000	0,077	K60X65X30
60	68	20	41,8	86,5	6700	7500	0,071	K60X68X20
60	68	23	47,3	102	6700	7500	0,094	K60X68X23
60	68	25	51,2	112	6700	7500	0,089	K60X68X25
60	75	42	112	196	6300	7500	0,24	K60X75X42
64	70	16	26,4	60	6300	7500	0,053	K64X70X16
65	70	20	29,2	76,5	6300	7500	0,056	K65X70X20
65	70	30	41,8	125	6300	7500	0,083	K65X70X30
65	73	23	41,8	90	6300	7000	0,11	K65X73X23
65	73	30	53,9	125	6300	7000	0,14	K65X73X30
68	74	20	33,6	83	6000	7000	0,071	K68X74X20
68	74	30	44,6	118	6000	7000	0,1	K68X74X30
70	76	20	34,1	86,5	6000	6700	0,071	K70X76X20
70	76	30	50,1	140	6000	6700	0,11	K70X76X30
70	78	30	57,2	137	6000	6700	0,15	K70X78X30

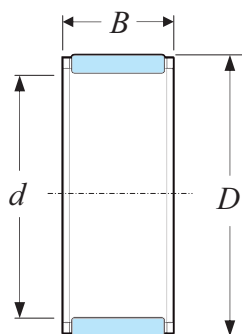

## NEEDLE ROLLER BEARINGS

### Needle Roller & Cage Assemblies

Table 74  
Diameter 72mm - 100mm

Principal Dimension			Basic Load Ratings		Speed Ratings		Mass	Designations
d	D	B	Dynamic	Static	Ref. Speed	Limiting Speed		
mm			C	C <sub>0</sub>	r/min		kg	CT
72	80	20	39,6	85	5600	6300	0,098	K72X80X20
73	79	20	35,2	90	5600	6300	0,075	K73X79X20
75	81	20	35,8	93	5600	6300	0,079	K75X81X20
75	81	30	50,1	143	5600	6300	0,11	K75X81X30
75	83	23	47,3	110	5300	6300	0,12	K75X83X23
75	83	30	59,4	143	5300	6300	0,15	K75X83X30
80	86	20	36,9	98	5300	6000	0,06	K80X86X20
80	88	30	68,2	176	5000	6000	0,14	K80X88X30
85	92	20	42,9	108	4800	5600	0,1	K85X92X20
90	97	20	42,9	114	4500	5300	0,11	K90X97X20
90	98	27	58,3	150	4500	5300	0,15	K90X98X27
90	98	30	64,4	173	4500	5300	0,17	K90X98X30
95	103	30	66	180	4300	5000	0,17	K95X103X30
100	107	21	45,7	127	4000	4800	0,12	K100X107X21
100	108	27	55	143	4000	4800	0,19	K100X108X27
100	108	30	67,1	190	4000	4800	0,18	K100X108X30



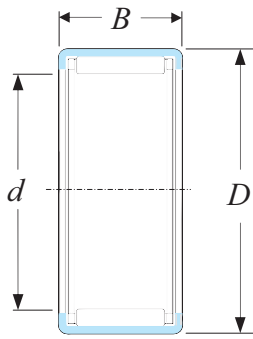

## NEEDLE ROLLER BEARINGS

### Drawn Cup

Table 75  
Diameter 3mm - 30mm

Principal Dimension			Basic Load Ratings		Speed Ratings		Mass	Designations
d	D	B	Dynamic Static		Ref. Speed	Limiting Speed		
mm			C	C <sub>0</sub>	r/min		kg	CT
3	6,5	6	1,23	0,88	24000	26000	0,001	HK0306-TV
4	8	8	1,76	1,37	22000	26000	0,002	HK0408
5	9	9	2,38	2,08	22000	24000	0,002	HK0509
6	10	6	1,72	1,29	22000	20000	0,0015	HK0606
6	10	8	2,01	1,73	20000	22000	0,0021	HK0608
6	10	9	2,81	2,7	20000	22000	0,0025	HK0609
7	11	9	3,03	3,05	20000	22000	0,0026	HK0709
8	12	8	2,7	2,75	19000	22000	0,0027	HK0808
8	12	10	3,69	4,05	19000	22000	0,003	HK0810
9	13	8	3,52	3,9	20000	20000	0,003	HK0908
9	13	10	4,13	4,8	18000	20000	0,004	HK0910
9	13	12	5,12	6,4	18000	20000	0,0046	HK0912
10	14	10	4,29	5,3	18000	20000	0,0041	HK1010
10	14	12	5,39	6,95	18000	20000	0,0048	HK1012
10	14	15	6,6	9	18000	20000	0,006	HK1015
12	16	10	4,84	6,4	16000	18000	0,0046	HK1210
12	18	12	6,27	7,35	16000	18000	0,009	HK1212
13	19	12	6,6	8	16000	17000	0,01	HK1312
14	20	12	6,82	8,65	15000	17000	0,011	HK1412
15	21	12	7,65	9,5	15000	16000	0,011	HK1512
15	21	16	10,1	14,6	15000	16000	0,015	HK1516
15	21	22	13	20	15000	16000	0,02	HK1522-ZW
16	22	12	7,37	9,8	14000	16000	0,012	HK1612
16	22	16	10,5	15,6	14000	16000	0,016	HK1616
16	22	22	12,8	19,6	14000	16000	0,022	HK1622-ZW
17	23	12	7,65	10,6	14000	15000	0,012	HK1712
18	24	12	7,92	11,2	13000	15000	0,013	HK1812
18	24	16	11,2	17,6	13000	15000	0,018	HK1816
20	26	10	6,16	8,5	12000	14000	0,012	HK2010
20	26	12	8,42	12,5	12000	14000	0,014	HK2012
20	26	16	12,3	20,4	12000	14000	0,019	HK2016
20	26	20	15,1	26,5	12000	14000	0,024	HK2020
20	26	30	20,9	40,5	12000	14000	0,035	HK2030-ZW
22	28	10	7,21	10,6	11000	12000	0,013	HK2210
22	28	12	8,8	13,7	11000	12000	0,015	HK2212
22	28	16	13	22,4	11000	12000	0,021	HK2216
22	28	20	15,7	29	11000	12000	0,026	HK2220
25	32	12	10,5	15,3	9500	11000	0,02	HK2512
25	32	16	15,1	24	9500	11000	0,027	HK2516
25	32	20	19	32,5	9500	11000	0,033	HK2520
25	32	26	24,2	45	9500	11000	0,044	HK2526
25	32	38	33	65,5	9500	11000	0,064	HK2538-ZW
28	35	16	15,7	26,5	9000	9500	0,029	HK2816
28	35	20	20,1	36,5	9000	9500	0,036	HK2820
30	37	12	11,7	18,3	8000	9000	0,023	HK3012
30	37	16	16,5	29	8000	9000	0,031	HK3016
30	37	20	20,9	40	8000	9000	0,039	HK3020
30	37	22	23,8	46,5	9000	8000	0,042	HK3022
30	37	26	27	54	8000	9000	0,051	HK3026
30	37	38	35,8	80	8000	9000	0,076	HK3038-ZW

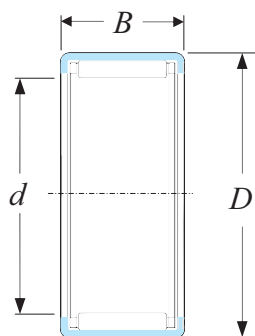

## NEEDLE ROLLER BEARINGS

### Drawn Cup

Table 76  
Diameter 32mm - 60mm

Principal Dimension			Basic Load Ratings		Speed Ratings		Mass	Designations
d	D	B	Dynamic	Static	Ref. Speed	Limiting Speed		
mm			C	Co	r/min		kg	CT
32	39	20	22	43	8500	7500	0,041	HK3220
32	39	24	26,4	54	8500	7500	0,049	HK3224
35	42	12	12,5	21,6	7000	8000	0,027	HK3512
35	42	16	17,9	34	7000	8000	0,036	HK3516
35	42	20	22,9	46,5	7000	8000	0,044	HK3520
40	47	12	13,4	24,5	6300	7000	0,03	HK4012
40	47	16	19	39	6300	7000	0,039	HK4016
40	47	20	24,2	53	6300	7000	0,054	HK4020
45	52	12	14,2	27,5	5600	6300	0,033	HK4512
45	52	16	20,5	43	5600	6300	0,046	HK4516
45	52	20	26	60	5600	6300	0,056	HK4520
50	58	20	29,2	63	5000	5600	0,07	HK5020
50	58	25	36,9	85	5000	5600	0,09	HK5025
55	63	20	30,3	67	4500	5000	0,074	HK5520
55	63	28	41,8	104	4500	5000	0,11	HK5528
60	68	12	17,6	32	4300	4800	0,049	HK6012
60	68	20	31,9	75	4300	4800	0,081	HK6020
60	68	32	51,2	137	4300	4800	0,14	HK6032

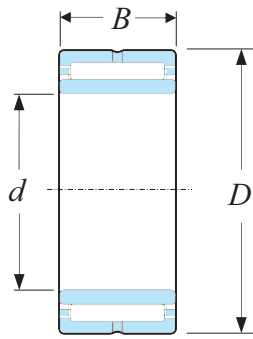

## NEEDLE ROLLER BEARINGS

### Solid Needle Roller Bearings

Table 77  
Diameter 10mm - 120mm

Principal Dimension			Basic Load Ratings		Speed Ratings		Mass	Designations
d	D	B	Dynamic Static		Ref. Speed	Limiting Speed		
mm			C	C <sub>0</sub>	r/min		kg	CT
10	22	13	8,8	10,4	24000	28000	0,023	NA 4900
12	24	13	9,9	12,2	22000	26000	0,026	NA 4901
12	24	22	16,1	23,2	22000	26000	0,046	NA 6901
15	28	13	11,2	15,3	19000	22000	0,034	NA 4902
15	28	23	17,2	27	19000	22000	0,064	NA 6902
17	30	13	11,4	16,3	18000	20000	0,037	NA 4903
17	30	23	18,7	30,5	18000	20000	0,072	NA 6903
20	37	17	21,6	28	15000	17000	0,075	NA 4904
20	37	30	35,2	53	15000	17000	0,14	NA 6904
22	39	17	23,3	32	14000	15000	0,08	NA 49/22
22	39	30	36,9	57	14000	15000	0,15	NA 69/22
25	42	17	24,2	34,5	13000	15000	0,088	NA 4905
25	42	30	38	62	13000	15000	0,16	NA 6905
28	45	17	25,1	36,5	12000	14000	0,098	NA 49/28
28	45	30	39,6	65,5	12000	14000	0,18	NA 69/28
30	47	17	25,5	39	11000	13000	0,1	NA 4906
30	47	30	42,9	75	11000	13000	0,19	NA 6906
32	52	20	30,8	51	10000	11000	0,16	NA 49/32
32	52	36	47,3	90	10000	11000	0,29	NA 69/32
35	55	20	31,9	54	9500	11000	0,17	NA 4907
35	55	36	48,4	93	9500	11000	0,31	NA 6907
40	62	22	42,9	71	8000	9500	0,23	NA 4908
40	62	40	67,1	125	8000	9500	0,43	NA 6908
45	68	22	45,7	78	7500	8500	0,27	NA 4909
45	68	40	70,4	137	7500	8500	0,5	NA 6909
50	72	22	47,3	85	7000	8000	0,27	NA 4910
50	72	40	73,7	150	7000	8000	0,52	NA 6910
55	80	25	57,2	106	6300	7000	0,39	NA 4911
55	80	45	89,7	190	6300	7000	0,78	NA 6911
60	85	25	60,5	114	6000	6700	0,43	NA 4912
60	85	45	93,5	204	6000	6700	0,81	NA 6912
65	90	25	61,6	120	5600	6300	0,46	NA 4913
65	90	45	95,2	212	5600	6300	0,83	NA 6913
70	100	30	84,2	163	5000	5600	0,73	NA 4914
70	100	54	128	285	5000	5600	1,35	NA 6914
75	105	30	84,2	170	4800	5300	0,78	NA 4915
75	105	54	130	290	4800	5300	1,45	NA 6915
80	110	30	88	183	4500	5000	0,88	NA 4916
80	110	54	134	315	4500	5000	1,5	NA 6916
85	120	35	108	250	4000	4500	1,25	NA 4917
85	120	63	165	425	4000	4500	2,2	NA 6917
90	125	35	112	265	3800	4300	1,3	NA 4918
90	125	63	172	450	3800	4300	2,3	NA 6918
95	130	35	114	270	3600	4000	1,35	NA 4919
95	130	63	172	465	3600	4000	2,5	NA 6919
100	140	40	125	280	3400	4000	1,9	NA 4920
110	140	30	93,5	232	3400	3800	1,1	NA 4822
110	150	40	130	300	3200	3600	2,05	NA 4922
120	150	30	99	255	3200	3600	1,15	NA 4824
120	165	45	176	405	3000	3400	2,85	NA 4924

## BEARING UNITS

Bearing units are basically a combination of a ball bearing for radial loads, seal, and a cast steel housing that is made in various shapes. Bearing units are self-aligning and insensitive to shaft misalignment or deflection, the bearing outer surface and the housing inner surface are both spherical. An oil proof duplex seal which is made of synthetic rubber is provided at both side of the bearing.

### Pillow Type Units

Pillow type unit is the most common type among all bearing units. Its' housing with the robust and solid base rib at the mounting section provides the capability enduring great loads from any direction. They are available as UCP and UKP type in this series, which its' housings are made of cast steel. Pillow type units are greatly suitable for application where sever loading and shock load conditions are expected during operation. They are widely used in general transmission equipment and machinery applications.

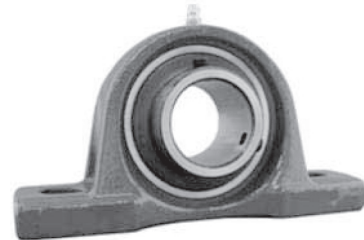

### Square Four-Bolts Flange Type Units

Square four bolt flange type units provide another robust mounting method, where the mounting bolts are orientated axially to the shaft. Flange type units are suitable where condition the mounting surface has 90° mating to the shaft. The flange units are mounted with four bolts, which enabled it can be easily attached or detached from the mounting applications. UCF and UKF are available in the series.

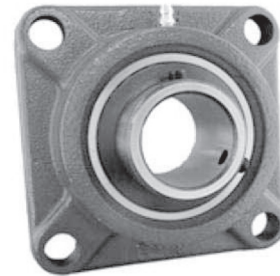

### Oval Flange Type Units

The flange unit of this bearing is made to oval shape, with two mounting bolt hole, which makes it for even easier installation. The main advantage of this unit is it needs less space for installation, and specifically suitable where mounting space is limited. Oval flange units are often used where a situation that there are two shafts installation and it is technically necessary to minimize the distance between the two shafts. Oval flange unit mounting hole is basically conforming to square flange unit mounting dimension at the diagonal position of holes



### Round Flange Cartridge Type Units

The round cartridge type unit has a round shaped cartridge at the back side of the flange. The cartridge design provides the unit with capability of precise mounting. Round flange cartridge type units are suitable where precise mounting accuracy is necessity.



### Take Up Type Units

Take up type bearing units are greatly suitable for applications where the mounted shaft or rollers need an adjustable capability. The notch of take up units fit at the linear track of the take up frame and this has allowed a linear adjustment along the plane of the frame. Take up units has widely used for industrial automation equipment, such as conveyors.

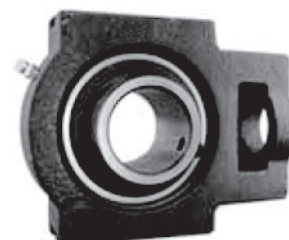

## BEARING UNITS

### Pillow Type Units, UCP

Table 78

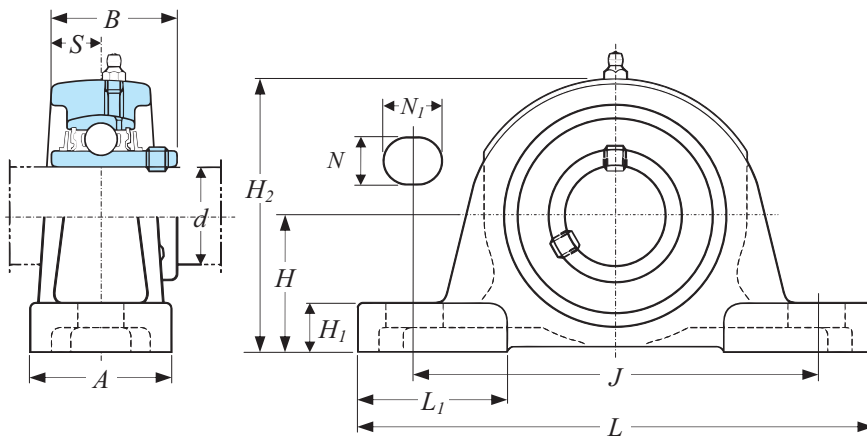
 Bore Diameter  
12mm – 140mm

Principal Dimension												Bolt Size	Basic Load Ratings		Fact f <sub>0</sub>	Mass kg	Designations		
d mm	H	L	A	J	N	N <sub>1</sub>	H <sub>1</sub>	H <sub>2</sub>	L <sub>1</sub>	B	S		C <sub>r</sub> kN	C <sub>or</sub>			Housing No	Bearing No	Unit No
12	30,2	127	38	95	13	18	12	60	38	31	12,7	M10	12,8	6,65	13,2	0,63	P203	UC201	UCP201
15	30,2	127	38	95	13	18	12	60	38	31	12,7	M10	12,8	6,65	13,2	0,61	P203	UC202	UCP202
17	30,2	127	38	95	13	18	12	60	38	31	12,7	M10	12,8	6,65	13,2	0,6	P203	UC203	UCP203
20	33,3	127	38	95	13	18	13	64	38	31	12,7	M10	12,8	6,65	13,2	0,66	P204	UC204	UCP204
25	36,5	140	38	105	13	18	13	71	43	34,1	14,3	M10	14	7,85	13,9	0,8	P205	UC205	UCP205
	44,4	159	51	119	17	25	16	86	47	38,1	15,9	M14	19,5	11,3	13,9	1,5	PX05	UCX05	UCPX05
	45	175	45	132	17	20	16	85	55	38	15	M14	21,2	10,9	12,6	1,7	P305	UC305	UCP305
30	42,9	165	48	121	17	21	15	84	53	38,1	15,9	M14	19,5	11,3	13,9	1,3	P206	UC206	UCP206
	47,6	175	57	127	17	25	17	93	55	42,9	17,5	M14	25,7	15,4	13,9	2,1	PX06	UCX06	UCPX06
	50	180	50	140	17	20	17	95	53	43	17	M14	26,7	15	13,3	2,2	P306	UC306	UCP306
35	47,6	167	48	127	17	21	16	93	51	42,9	17,5	M14	25,7	15,4	13,9	1,6	P207	UC207	UCP207
	54	203	57	144	17	30	19	105	64	49,2	19	M14	29,1	17,8	14	2,7	PX07	UCX07	UCPX07
	56	210	56	160	17	25	19	107	65	48	19	M14	33,4	19,3	13,2	3	P307	UC307	UCP307
40	49,2	184	54	137	17	21	17	98	57	49,2	19	M14	29,1	17,8	14	2	P208	UC208	UCP208
	58,7	222	67	156	20	32	21	114	71	49,2	19	M16	34,1	21,3	14	3,5	PX08	UCX08	UCPX08
	60	220	60	170	17	27	19	118	65	52	19	M14	40,7	24	13,2	3,8	P308	UC308	UCP308
45	54	190	54	146	17	21	17	106	60	49,2	19	M14	34,1	21,3	14	2,2	P209	UC209	UCP209
	58,7	222	67	156	20	33	21	116	71	51,6	19	M16	35,1	23,3	14,4	3,7	PX09	UCX09	UCPX09
	67	245	67	190	20	30	21	132	75	57	22	M16	48,9	29,5	13,3	4,9	P309	UC309	UCP309
50	57,2	206	60	159	20	22	19	113	63	51,6	19	M16	35,1	23,3	14,4	2,9	P210	UC210	UCP210
	63,5	241	73	171	20	36	22	126	76	55,6	22,2	M16	43,4	29,4	14,4	4,6	PX10	UCX10	UCPX10
	75	275	75	212	20	35	24	148	88	61	22	M16	62	38,3	13,2	6,6	P310	UC310	UCP310
55	63,5	219	60	171	20	22	19	125	70	55,6	22,2	M16	43,4	29,4	14,4	3,6	P211	UC211	UCP211
	69,8	260	79	184	25	36	28	139	83	65,1	25,4	M20	52,4	36,2	14,4	6,5	PX11	UCX11	UCPX11
	80	310	80	236	20	38	27	158	90	66	25	M16	71,6	45	13,2	7,9	P311	UC311	UCP311
60	69,8	241	70	184	20	25	22	138	76	65,1	25,4	M16	52,4	36,2	14,4	4,9	P212	UC212	UCP212
	76,2	286	83	203	25	40	28	152	88	65,1	25,4	M20	57,2	40,1	14,4	7,7	PX12	UCX12	UCPX12
60	85	330	85	250	25	38	29	167	103	71	26	M20	81,9	52,2	13,2	9,5	P312	UC312	UCP312
65	76,2	265	70	203	25	30	25	150	78	65,1	25,4	M20	57,2	40,1	14,4	5,9	P213	UC213	UCP213
	76,2	286	83	203	25	40	28	155	88	74,6	30,2	M20	62,2	44,1	14,5	8,1	PX13	UCX13	UCPX13
	90	340	90	260	25	38	32	176	110	75	30	M20	92,7	59,9	13,2	10,7	P313	UC313	UCP313
70	79,4	266	72	210	25	30	28	156	78	74,6	30,2	M20	62,2	44,1	14,5	6,8	P214	UC214	UCP214
	88,9	330	89	229	27	50	32	171	98	77,8	33,3	M22	67,4	48,3	14,5	10,2	PX14	UCX14	UCPX14
	95	360	90	280	27	40	35	186	110	78	33	M22	104	68,2	13,2	12,4	P314	UC314	UCP314
75	82,6	275	74	217	25	30	28	162	80	77,8	33,3	M20	67,4	48,3	14,5	7,4	P215	UC215	UCP215
	88,9	330	89	229	27	50	32	175	99	82,6	33,3	M22	72,7	53	14,6	10,8	PX15	UCX15	UCPX15
	100	380	100	290	27	40	35	198	107	82	32	M22	113	77,2	13,2	14,8	P315	UC315	UCP315
80	88,9	292	78	232	25	35	32	174	86	82,6	33,3	M20	72,7	53	14,6	9	P216	UC216	UCP216
	101,6	381	102	283	27	58	34	195	116	85,7	34,1	M22	84	61,9	14,5	15,3	PX16	UCX16	UCPX16
	106	400	110	300	27	40	35	209	120	86	34	M22	123	86,7	13,3	18,5	P316	UC316	UCP316
85	95,2	310	83	247	25	40	32	185	90	85,7	34,1	M20	84	61,9	14,5	10,8	P217	UC217	UCP217
	101,6	381	102	283	27	60	34	200	116	96	39,7	M22	96,1	71,5	14,5	16,1	PX17	UCX17	UCPX17
	112	420	110	320	33	45	40	220	120	96	40	M27	133	96,8	13,3	20,3	P317	UC317	UCP317
90	101,6	327	88	262	27	45	34	198	104	96	39,7	M22	96,1	71,5	14,5	13,9	P218	UC218	UCP218
	101,6	381	111	283	27	60	38	204	116	104	42,9	M22	109	81,9	14,4	19,1	PX18	UCX18	UCPX18
	118	430	110	330	33	45	40	234	120	96	40	M27	143	107	13,3	22,8	P318	UC318	UCP318
95	125	470	120	360	36	50	46	248	125	103	41	M30	153	119	13,3	29	P319	UC319	UCP319
100	127	432	121	337	33	65	45	245	126	117,5	49,2	M27	133	105	14,4	30,4	PX20	UCX20	UCPX20
	140	490	120	380	36	50	46	273	140	108	42	M30	173	141	13,2	35,1	P320	UC320	UCP320
105	140	490	120	380	36	50	46	278	140	112	44	M30	184	153	13,2	37,6	P321	UC321	UCP321
110	150	520	140	400	40	55	50	296	150	117	46	M33	205	180	13,2	44	P322	UC322	UCP322
120	160	570	140	450	40	55	50	316	160	126	51	M33	207	185	13,5	55,4	P324	UC324	UCP324
130	180	600	140	480	40	55	50	355	195	135	54	M33	229	214	13,6	72,1	P326	UC326	UCP326
140	200	620	140	500	40	55	60	393	185	145	59	M33	253	246	13,6	92,5	P328	UC328	UCP328

## BEARING UNITS

### Pillow Type Units, UKP

Table 79

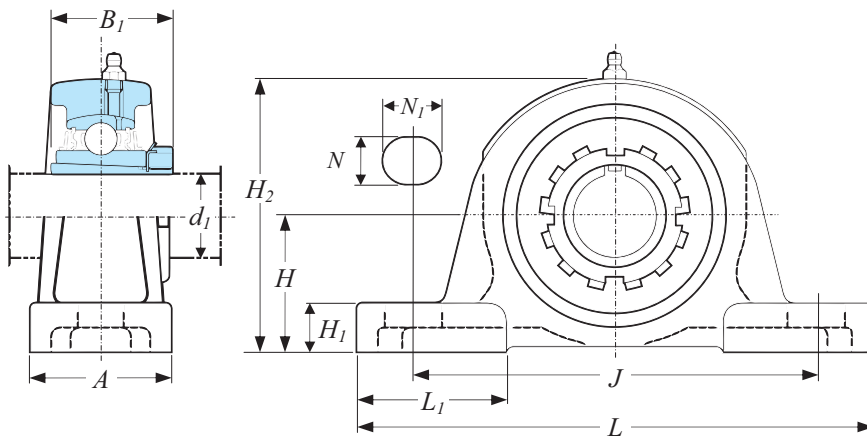
 Bore Diameter  
20mm – 125mm

Principal Dimension												Bolt Size	Basic Load Ratings		Fact f <sub>0</sub>	Mass kg	Designations		
d	H	L	A	J	N	N <sub>1</sub>	H <sub>1</sub>	H <sub>2</sub>	L <sub>1</sub>	B	Cr		Cor	Housing No			Bearing No	Unit No	
mm												mm	kN						
20	36,5	140	38	105	13	18	13	71	43	29	M10	14	7,85	13,9	0,84	P205	UK205	UKP205	
	44,4	159	51	119	17	25	16	86	47	35	M14	19,5	11,3	13,9	1,5	PX05	UKX05	UKPX05	
	45	175	45	132	17	20	16	85	55	35	M14	21,2	10,9	12,6	1,7	P305	UK305	UKP305	
25	42,9	165	48	121	17	21	15	84	53	31	M14	19,5	11,3	13,9	1,4	P206	UK206	UKP206	
	47,6	175	57	127	17	25	17	93	55	38	M14	25,7	15,4	13,9	2,1	PX06	UKX06	UKPX06	
	50	180	50	140	17	20	17	95	53	38	M14	26,7	15	13,3	2,3	P306	UK306	UKP306	
30	47,6	167	48	127	17	21	16	93	51	35	M14	25,7	15,4	13,9	1,7	P207	UK207	UKP207	
	54	203	57	144	17	30	19	105	64	43	M14	29,1	17,8	14	2,7	PX07	UKX07	UKPX07	
	56	210	56	160	17	25	19	107	65	43	M14	33,4	19,3	13,2	3	P307	UK307	UKP307	
35	49,2	184	54	137	17	21	17	98	57	36	M14	29,1	17,8	14	2	P208	UK208	UKP208	
	58,7	222	67	156	20	32	21	114	71	46	M16	34,1	21,3	14	3,5	PX08	UKX08	UKPX08	
	60	220	60	170	17	27	19	118	65	46	M14	40,7	24	13,2	3,8	P308	UK308	UKP308	
40	54	190	54	146	17	21	17	106	60	39	M14	34,1	21,3	14	2,3	P209	UK209	UKP209	
	58,7	222	67	156	20	33	21	116	71	50	M16	35,1	23,3	14,4	3,7	PX09	UKX09	UKPX09	
	67	245	67	190	20	30	21	132	75	50	M16	48,9	29,5	13,3	5	P309	UK309	UKP309	
45	57,2	206	60	159	20	22	19	113	63	42	M16	35,1	23,3	14,4	3	P210	UK210	UKP210	
	63,5	241	73	171	20	36	22	126	76	55	M16	43,4	29,4	14,4	4,6	PX10	UKX10	UKPX10	
	75	275	75	212	20	35	24	148	88	55	M16	62	38,3	13,2	6,7	P310	UK310	UKP310	
50	63,5	219	60	171	20	22	19	125	70	45	M16	43,4	29,4	14,4	3,7	P211	UK211	UKP211	
	69,8	260	79	184	25	36	28	139	83	59	M20	52,4	36,2	14,4	6,2	PX11	UKX11	UKPX11	
	80	310	80	236	20	38	27	158	90	59	M16	71,6	45	13,2	8,1	P311	UK311	UKP311	
55	69,8	241	70	184	20	25	22	138	76	47	M16	52,4	36,2	14,4	4,8	P212	UK212	UKP212	
	76,2	286	83	203	25	40	28	152	88	62	M20	57,2	40,1	14,4	7,5	PX12	UKX12	UKPX12	
	85	330	85	250	25	38	29	167	103	62	M20	81,9	52,2	13,2	9,4	P312	UK312	UKP312	
60	76,2	265	70	203	25	30	25	150	78	50	M20	57,2	40,1	14,4	5,8	P213	UK213	UKP213	
	76,2	286	83	203	25	40	28	155	88	65	M20	62,2	44,1	14,5	7,8	PX13	UKX13	UKPX13	
60	90	340	90	260	25	38	32	176	110	65	M20	92,7	59,9	13,2	10,8	P313	UK313	UKP313	
65	82,6	275	74	217	25	30	28	162	80	55	M20	67,4	48,3	14,5	7,5	P215	UK215	UKP215	
	88,9	330	89	229	27	50	32	175	99	73	M22	72,7	53	14,6	10,5	PX15	UKX15	UKPX15	
	100	380	100	290	27	40	35	198	107	73	M22	113	77,2	13,2	14,9	P315	UK315	UKP315	
70	88,9	292	78	232	25	35	32	174	86	59	M20	72,7	53	14,6	9,2	P216	UK216	UKP216	
	101,6	381	102	283	27	58	34	195	116	78	M22	84	61,9	14,5	15,4	PX16	UKX16	UKPX16	
	106	400	110	300	27	40	35	209	120	78	M22	123	86,7	13,3	18,6	P316	UK316	UKP316	
75	95,2	310	83	247	25	40	32	185	90	63	M20	84	61,9	14,5	11	P217	UK217	UKP217	
	101,6	381	102	283	27	60	34	200	116	82	M22	96,1	71,5	14,5	15,8	PX17	UKX17	UKPX17	
	112	420	110	320	33	45	40	220	120	82	M27	133	96,8	13,3	20,2	P317	UK317	UKP317	
80	101,6	327	88	262	27	45	34	198	104	65	M22	96,1	71,5	14,5	13,8	P218	UK218	UKP218	
	101,6	381	111	283	27	60	38	204	116	86	M22	109	81,9	14,4	18,6	PX18	UKX18	UKPX18	
	118	430	110	330	33	45	40	234	120	86	M27	143	107	13,3	22,8	P318	UK318	UKP318	
85	125	470	120	360	36	50	46	248	125	90	M30	153	119	13,3	29,3	P319	UK319	UKP319	
90	127	432	121	337	33	65	45	245	126	97	M27	133	105	14,4	29,3	PX20	UKX20	UKPX20	
	140	490	120	380	36	50	46	273	140	97	M30	173	141	13,2	34,8	P320	UK320	UKP320	
100	150	520	140	400	40	55	50	296	150	105	M33	205	180	13,2	43,9	P322	UK322	UKP322	
110	160	570	140	450	40	55	50	316	160	112	M33	207	185	13,5	55,7	P324	UK324	UKP324	
115	180	600	140	480	40	55	50	355	195	121	M33	229	214	13,6	71,9	P326	UK326	UKP326	
125	200	620	140	500	40	55	60	393	185	131	M33	253	246	13,6	92,5	P328	UK328	UKP328	

## BEARING UNITS

### Square Four-Bolt Flange Type Unit, UCF

Table 80

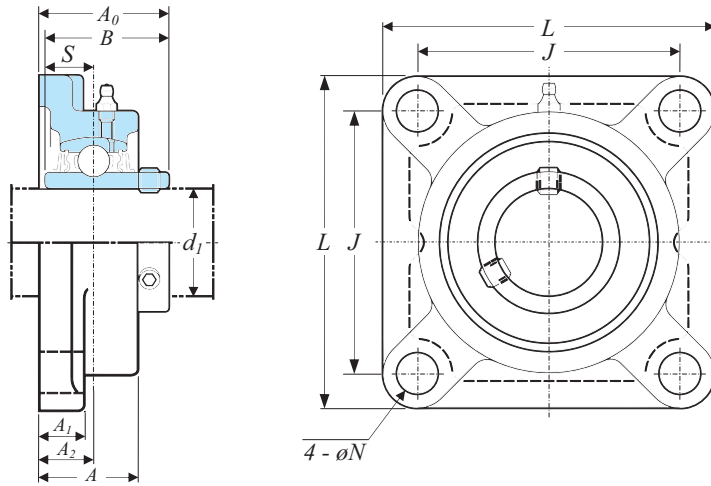
 Bore Diameter  
12mm – 140mm

Principal Dimension										Bolt Size	Basic Load Ratings		Fact f <sub>0</sub>	Mass kg	Designations		
d	L	A	J	N	A <sub>1</sub>	A <sub>2</sub>	A <sub>0</sub>	B	S		Cr	Cor			Housing No	Bearing No	Unit No
mm										mm	kN			No	No	No	
12	86	25	,5 64	12	11	15	33,3	31	12,7	M10	12,8	6,65	13,2	0,64	F204	UC201	UCF201
15	86	25	,5 64	12	11	15	33,3	31	12,7	M10	12,8	6,65	13,2	0,62	F204	UC202	UCF202
17	86	25	,5 64	12	11	15	33,3	31	12,7	M10	12,8	6,65	13,2	0,61	F204	UC203	UCF203
20	86	25	,5 64	12	11	15	33,3	31	12,7	M10	12,8	6,65	13,2	0,59	F204	UC204	UCF204
25	95	27	70	12	13	16	35,8	34,1	14,3	M10	14	7,85	13,9	0,83	F205	UC205	UCF205
	108	30	83	12	13	18	40,2	38,1	15,9	M10	19,5	11,3	13,9	1,2	FX05	UCX05	UCFX05
	110	29	80	16	13	16	39	38	15	M14	21,2	10,9	12,6	1,3	F305	UC305	UCF305
30	108	31	83	12	13	18	40,2	38,1	15,9	M10	19,5	11,3	13,9	1,1	F206	UC206	UCF206
	117	34	92	16	14	19	44,4	42,9	17,5	M14	25,7	15,4	13,9	1,6	FX06	UCX06	UCFX06
	125	32	95	16	15	18	44	43	17	M14	26,7	15	13,3	1,9	F306	UC306	UCF306
35	117	34	92	14	15	19	44,4	42,9	17,5	M12	25,7	15,4	13,9	1,5	F207	UC207	UCF207
	130	38	102	16	14	21	51,2	49,2	19	M14	29,1	17,8	14	2	FX07	UCX07	UCFX07
	135	36	100	19	16	20	49	48	19	M16	33,4	19,3	13,2	2,3	F307	UC307	UCF307
40	130	36	102	16	15	21	51,2	49,2	19	M14	29,1	17,8	14	1,9	F208	UC208	UCF208
	137	40	105	19	14	22	52,2	49,2	19	M16	34,1	21,3	14	2,4	FX08	UCX08	UCFX08
	150	40	112	19	17	23	56	52	19	M16	40,7	24	13,2	3,1	F308	UC308	UCF308
45	137	38	105	16	16	22	52,2	49,2	19	M14	34,1	21,3	14	2,2	F209	UC209	UCF209
	143	40	111	19	14	23	55,6	51,6	19	M16	35,1	23,3	14,4	2,7	FX09	UCX09	UCFX09
	160	44	125	19	18	25	60	57	22	M16	48,9	29,5	13,3	4	F309	UC309	UCF309
50	143	40	111	16	16	22	54,6	51,6	19	M14	35,1	23,3	14,4	2,5	F210	UC210	UCF210
	162	44	130	19	20	26	59,4	55,6	22,2	M16	43,4	29,4	14,4	3,7	FX10	UCX10	UCFX10
	175	48	132	23	19	28	67	61	22	M20	62	38,3	13,2	5,1	F310	UC310	UCF310
55	162	43	130	19	18	25	58,4	55,6	22,2	M16	43,4	29,4	14,4	3,4	F211	UC211	UCF211
	175	49	143	19	20	29	68,7	65,1	25,4	M16	52,4	36,2	14,4	4,9	FX11	UCX11	UCFX11
	185	52	140	23	20	30	71	66	25	M20	71,6	45	13,2	5,6	F311	UC311	UCF311
60	175	48	143	19	18	29	68,7	65,1	25,4	M16	52,4	36,2	14,4	4,2	F212	UC212	UCF212
	187	59	149	19	21	34	73,7	65,1	25,4	M16	57,2	40,1	14,4	5,7	FX12	UCX12	UCFX12
	195	56	150	23	22	33	78	71	26	M20	81,9	52,2	13,2	6,9	F312	UC312	UCF312
65	187	50	149	19	22	30	69,7	65,1	25,4	M16	57,2	40,1	14,4	5,2	F213	UC213	UCF213
	187	59	149	19	21	34	78,4	74,6	30,2	M16	62,2	44,1	14,5	6,3	FX13	UCX13	UCFX13
	208	58	166	23	22	33	78	75	30	M20	92,7	59,9	13,2	7,8	F313	UC313	UCF313
70	193	54	152	19	22	31	75,4	74,6	30,2	M16	62,2	44,1	14,5	5,9	F214	UC214	UCF214
	197	60	152	23	22	37	81,5	77,8	33,3	M20	67,4	48,3	14,5	7	FX14	UCX14	UCFX14
	226	61	178	25	25	36	81	78	33	M22	104	68,2	13,2	10,1	F314	UC314	UCF314
75	200	56	159	19	22	34	78,5	77,8	33,3	M16	67,4	48,3	14,5	6,4	F215	UC215	UCF215
	197	68	152	23	24	40	89,3	82,6	33,3	M20	72,7	53	14,6	8,4	FX15	UCX15	UCFX15
	236	66	184	25	25	39	89	82	32	M22	113	77,2	13,2	11,6	F315	UC315	UCF315
80	208	58	165	23	22	34	83,3	82,6	33,3	M20	72,7	53	14,6	7,3	F216	UC216	UCF216
	214	70	171	23	24	40	91,6	85,7	34,1	M20	84	61,9	14,5	9,4	FX16	UCX16	UCFX16
	250	68	196	31	27	38	90	86	34	M27	123	86,7	13,3	12,8	F316	UC316	UCF316
85	220	63	175	23	24	36	87,6	85,7	34,1	M20	84	61,9	14,5	8,9	F217	UC217	UCF217
	214	70	171	23	24	40	96,3	96	39,7	M20	96,1	71,5	14,5	10,8	FX17	UCX17	UCFX17
	260	74	204	31	27	44	100	96	40	M27	133	96,8	13,3	15,3	F317	UC317	UCF317
90	235	68	187	23	25	40	96,3	96	39,7	M20	96,1	71,5	14,5	11,4	F218	UC218	UCF218
	214	76	171	23	24	45	106,1	104	42,9	M20	109	81,9	14,4	11,9	FX18	UCX18	UCFX18
	280	76	216	35	30	44	100	96	40	M30	143	107	13,3	18,9	F318	UC318	UCF318
95	290	94	228	35	30	59	121	103	41	M30	153	119	13,3	21,6	F319	UC319	UCF319
100	268	97	211	31	28	59	127,3	117,5	49,2	M27	133	105	14,4	19,4	FX20	UCX20	UCFX20
	310	94	242	38	32	59	125	108	42	M33	173	141	13,2	25,8	F320	UC320	UCF320
105	310	94	242	38	32	59	127	112	44	M33	184	153	13,2	30,2	F321	UC321	UCF321
110	340	96	266	41	35	60	131	117	46	M36	205	180	13,2	35,3	F322	UC322	UCF322
120	370	11	0 290	41	40	65	140	126	51	M36	207	185	13,5	47,3	F324	UC324	UCF324
130	410	11	5 320	41	45	65	146	135	54	M36	229	214	13,6	65,5	F326	UC326	UCF326
140	450	12	5 350	41	55	75	161	145	59	M36	253	246	13,6	93,4	F328	UC328	UCF328

**BEARING UNITS**  
 Square Four-Bolt  
 Flange Type Unit, UKF

Table 81

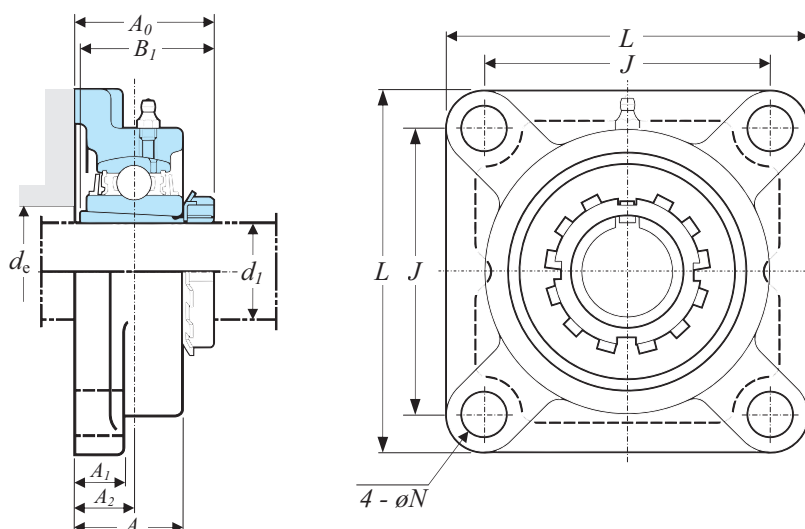
 Bore Diameter  
 20mm – 125mm

Principal Dimension										Bolt Size	Basic Load Ratings		Fact f <sub>0</sub>	Mass kg	Designations			
d	L	A	J	N	A <sub>1</sub>	A <sub>2</sub>	A <sub>0</sub>	B <sub>1</sub>	d <sub>e</sub>		C <sub>r</sub>	C <sub>0r</sub>			Housing No	Bearing No	Unit No	Adapter No
mm										mm	kN							
20	95	27	70	12	13	16	34,5	29	30	M10	14	7,85	13,9	0,87	F205	UK205	UKF205	H305X
	108	30	83	12	13	18	37,5	35	30	M10	19,5	11,3	13,9	1,2	FX05	UKX05	UKFX05	H2305X
	110	29	80	16	13	16	37,5	35	-	M14	21,2	10,9	12,6	1,4	F305	UK305	UKF305	H2305X
25	108	31	83	12	13	18	37,5	31	36	M10	19,5	11,3	13,9	1,3	F206	UK206	UKF206	H306X
	117	34	92	16	14	19	40	38	36	M14	25,7	15,4	13,9	1,6	FX06	UKX06	UKFX06	H2306X
	125	32	95	16	15	18	41	38	-	M14	26,7	15	13,3	1,9	F306	UK306	UKF306	H2306X
30	117	34	92	14	15	19	41	35	41	M12	25,7	15,4	13,9	1,6	F207	UK207	UKF207	H307X
	130	38	102	16	14	21	43,5	43	41	M14	29,1	17,8	14	2	FX07	UKX07	UKFX07	H2307X
	135	36	100	19	16	20	45,5	43	-	M16	33,4	19,3	13,2	2,3	F307	UK307	UKF307	H2307X
35	130	36	102	16	15	21	44,5	36	46	M14	29,1	17,8	14	1,9	F208	UK208	UKF208	H308X
	137	40	105	19	14	22	46,5	46	46	M16	34,1	21,3	14	2,3	FX08	UKX08	UKFX08	H2308X
	150	40	112	19	17	23	50,5	46	-	M16	40,7	24	13,2	3,1	F308	UK308	UKF308	H2308X
40	137	38	105	16	16	22	47,5	39	52	M14	34,1	21,3	14	2,3	F209	UK209	UKF209	H309X
	143	40	111	19	14	23	48,5	50	52	M16	35,1	23,3	14,4	2,7	FX09	UKX09	UKFX09	H2309X
	160	44	125	19	18	25	55	50	-	M16	48,9	29,5	13,3	4,1	F309	UK309	UKF309	H2309X
45	143	40	111	16	16	22	48,5	42	58	M14	35,1	23,3	14,4	2,6	F210	UK210	UKF210	H310X
	162	44	130	19	20	26	53,5	55	58	M16	43,4	29,4	14,4	3,6	FX10	UKX10	UKFX10	H2310X
	175	48	132	23	19	28	60	55	-	M20	62	38,3	13,2	5,1	F310	UK310	UKF310	H2310X
50	162	43	130	19	18	25	52,5	45	64	M16	43,4	29,4	14,4	3,5	F211	UK211	UKF211	H311X
	175	49	143	19	20	29	57,5	59	64	M16	52,4	36,2	14,4	4,6	FX11	UKX11	UKFX11	H2311X
	185	52	140	23	20	30	63,5	59	-	M20	71,6	45	13,2	5,9	F311	UK311	UKF311	H2311X
55	175	48	143	19	18	29	58,5	47	69	M16	52,4	36,2	14,4	4,1	F212	UK212	UKF212	H312X
	187	59	149	19	21	34	65	62	69	M16	57,2	40,1	14,4	5,5	FX12	UKX12	UKFX12	H2312X
	195	56	150	23	22	33	69,5	62	-	M20	81,9	52,2	13,2	6,8	F312	UK312	UKF312	H2312X
60	187	50	149	19	22	30	62	50	74	M16	57,2	40,1	14,4	5,1	F213	UK213	UKF213	H313X
	187	59	149	19	21	34	68	65	74	M16	62,2	44,1	14,5	6	FX13	UKX13	UKFX13	H2313X
	208	58	166	23	22	33	71,5	65	-	M20	92,7	59,9	13,2	7,9	F313	UK313	UKF313	H2313X
65	200	56	159	19	22	34	69	55	85	M16	67,4	48,3	14,5	6,5	F215	UK215	UKF215	H315X
	197	68	152	23	24	40	76	73	85	M20	72,7	53	14,6	8,1	FX15	UKX15	UKFX15	H2315X
	236	66	184	25	25	39	81,5	73	-	M22	113	77,2	13,2	11,7	F315	UK315	UKF315	H2315X
70	208	58	165	23	22	34	72	59	90	M20	72,7	53	14,6	7,6	F216	UK216	UKF216	H316X
	214	70	171	23	24	40	79	78	90	M20	84	61,9	14,5	9,5	FX16	UKX16	UKFX16	H2316X
	250	68	196	31	27	38	82,5	78	-	M27	123	86,7	13,3	12,9	F316	UK316	UKF316	H2316X
75	220	63	175	23	24	36	76	63	96	M20	84	61,9	14,5	9	F217	UK217	UKF217	H317X
	214	70	171	23	24	40	82	82	96	M20	96,1	71,5	14,5	10,4	FX17	UKX17	UKFX17	H2317X
	260	74	204	31	27	44	92	82	-	M27	133	96,8	13,3	15,2	F317	UK317	UKF317	H2317X
80	235	68	187	23	25	40	82	65	102	M20	96,1	71,5	14,5	11,4	F218	UK218	UKF218	H318X
	214	76	171	23	24	45	88	86	102	M20	109	81,9	14,4	11,4	FX18	UKX18	UKFX18	H2318X
	280	76	216	35	30	44	92	86	-	M30	143	107	13,3	19	F318	UK318	UKF318	H2318X
85	290	94	228	35	30	59	111	90	-	M30	153	119	13,3	21,9	F319	UK319	UKF319	H2319X
90	268	97	211	31	28	59	106	97	112	M27	133	105	14,4	18,4	FX20	UKX20	UKFX20	H2320X
	310	94	242	38	32	59	113	97	-	M33	173	141	13,2	25,4	F320	UK320	UKF320	H2320X
100	340	96	266	41	35	60	120	105	-	M36	205	180	13,2	35,2	F322	UK322	UKF322	H2322X
110	370	110	290	41	40	65	130,5	112	-	M36	207	185	13,5	47,6	F324	UK324	UKF324	H2324X
115	410	115	320	41	45	65	131,5	121	-	M36	229	214	13,6	65,3	F326	UK326	UKF326	H2326X
125	450	125	350	41	55	75	147,5	131	-	M36	253	246	13,6	93,4	F328	UK328	UKF328	H2328X



## BEARING UNITS

### Oval Flange Type unit

### UCFL

Table 82

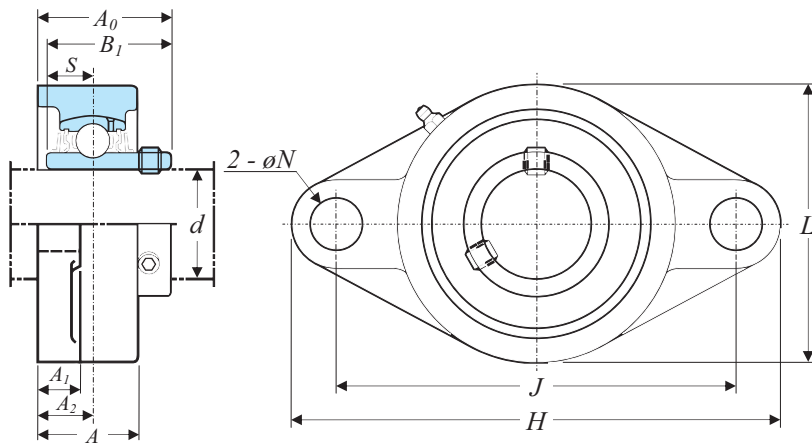
 Bore Diameter  
12mm – 140mm

Principal Dimension											Bolt Size	Basic Load Ratings		Fact f <sub>0</sub>	Mass kg	Designations		
d	H	L	A	J	N	A <sub>1</sub>	A <sub>2</sub>	A <sub>0</sub>	B	S		Cr	Cor			Housing No	Bearing No	Unit No
mm											mm	kN						
12	113	60	25,5	90	12	11	15	33,3	31	12,7	M10	12,8	6,65	13,2	0,5	FL204	UC201	UCFL201
15	113	60	25,5	90	12	11	15	33,3	31	12,7	M10	12,8	6,65	13,2	0,48	FL204	UC202	UCFL202
17	113	60	25,5	90	12	11	15	33,3	31	12,7	M10	12,8	6,65	13,2	0,47	FL204	UC203	UCFL203
20	113	60	25,5	90	12	11	15	33,3	31	12,7	M10	12,8	6,65	13,2	0,45	FL204	UC204	UCFL204
25	130	68	27	99	16	13	16	35,8	34,1	14,3	M14	14	7,85	13,9	0,64	FL205	UC205	UCFL205
	141	83	30	117	12	13	18	40,2	38,1	15,9	M10	19,5	11,3	13,9	1,1	FLX05	UCX05	UCFLX05
	150	80	29	113	19	13	16	39	38	15	M16	21,2	10,9	12,6	1,1	FL305	UC305	UCFL305
30	148	80	31	117	16	13	18	40,2	38,1	15,9	M14	19,5	11,3	13,9	0,93	FL206	UC206	UCFL206
	156	95	34	130	16	14	19	44,4	42,9	17,5	M14	25,7	15,4	13,9	1,5	FLX06	UCX06	UCFLX06
	180	90	32	134	23	15	18	44	43	17	M20	26,7	15	13,3	1,5	FL306	UC306	UCFL306
35	161	90	34	130	16	14	19	44,4	42,9	17,5	M14	25,7	15,4	13,9	1,2	FL207	UC207	UCFL207
	171	105	38	144	16	14	21	51,2	49,2	19	M14	29,1	17,8	14	1,9	FLX07	UCX07	UCFLX07
	185	100	36	141	23	16	20	49	48	19	M20	33,4	19,3	13,2	1,8	FL307	UC307	UCFL307
40	175	100	36	144	16	14	21	51,2	49,2	19	M14	29,1	17,8	14	1,6	FL208	UC208	UCFL208
	179	111	40	148	16	14	22	52,2	49,2	19	M14	34,1	21,3	14	2,1	FLX08	UCX08	UCFLX08
	200	112	40	158	23	17	23	56	52	19	M20	40,7	24	13,2	2,5	FL308	UC308	UCFL308
45	188	108	38	148	19	15	22	52,2	49,2	19	M16	34,1	21,3	14	1,9	FL209	UC209	UCFL209
	189	116	40	157	16	14	23	55,6	51,6	19	M14	35,1	23,3	14,4	2,4	FLX09	UCX09	UCFLX09
	230	125	44	177	25	18	25	60	57	22	M22	48,9	29,5	13,3	3,5	FL309	UC309	UCFL309
50	197	115	40	157	19	15	22	54,6	51,6	19	M16	35,1	23,3	14,4	2,2	FL210	UC210	UCFL210
	216	133	44	184	19	20	26	59,4	55,6	22,2	M16	43,4	29,4	14,4	3,8	FLX10	UCX10	UCFLX10
	240	140	48	187	25	19	28	67	61	22	M22	62	38,3	13,2	4,4	FL310	UC310	UCFL310
55	224	130	43	184	19	18	25	58,4	55,6	22,2	M16	43,4	29,4	14,4	3,3	FL211	UC211	UCFL211
	250	150	52	198	25	20	30	71	66	25	M22	71,6	45	13,2	5,3	FL311	UC311	UCFL311
60	250	140	48	202	23	18	29	68,7	65,1	25,4	M20	52,4	36,2	14,4	4,2	FL212	UC212	UCFL212
	270	160	56	212	31	22	33	78	71	26	M27	81,9	52,2	13,2	6,5	FL312	UC312	UCFL312
65	258	155	50	210	23	20	30	69,7	65,1	25,4	M20	57,2	40,1	14,4	5,1	FL213	UC213	UCFL213
	295	175	58	240	31	25	33	78	75	30	M27	92,7	59,9	13,2	8,5	FL313	UC313	UCFL313
70	265	160	54	216	23	20	31	75,4	74,6	30,2	M20	62,2	44,1	14,5	5,7	FL214	UC214	UCFL214
	315	185	61	250	35	28	36	81	78	33	M30	104	68,2	13,2	9,7	FL314	UC314	UCFL314
75	275	165	56	225	23	20	34	78,5	77,8	33,3	M20	67,4	48,3	14,5	6,4	FL215	UC215	UCFL215
	320	195	66	260	35	30	39	89	82	32	M30	113	77,2	13,2	11,3	FL315	UC315	UCFL315
80	290	180	58	233	25	20	34	83,3	82,6	33,3	M22	72,7	53	14,6	7,8	FL216	UC216	UCFL216
	355	210	68	285	38	32	38	90	86	34	M33	123	86,7	13,3	14,4	FL316	UC316	UCFL316
85	305	190	63	248	25	22	36	87,6	85,7	34,1	M22	84	61,9	14,5	9,8	FL217	UC217	UCFL217
	370	220	74	300	38	32	44	100	96	40	M33	133	96,8	13,3	16	FL317	UC317	UCFL317
90	320	205	68	265	25	23	40	96,3	96	39,7	M22	96,1	71,5	14,5	12,3	FL218	UC218	UCFL218
	385	235	76	315	38	36	44	100	96	40	M33	143	107	13,3	19	FL318	UC318	UCFL318
95	405	250	94	330	41	40	59	121	103	41	M36	153	119	13,3	24,6	FL319	UC319	UCFL319
100	440	270	94	360	44	40	59	125	108	42	M39	173	141	13,2	29,4	FL320	UC320	UCFL320
105	440	270	94	360	44	40	59	127	112	44	M39	184	153	13,2	34,4	FL321	UC321	UCFL321
110	470	300	96	390	44	42	60	131	117	46	M39	205	180	13,2	36,2	FL322	UC322	UCFL322
120	520	330	110	430	47	48	65	140	126	51	M42	207	185	13,5	51,6	FL324	UC324	UCFL324
130	550	360	115	460	47	50	65	146	135	54	M42	229	214	13,6	61,6	FL326	UC326	UCFL326
140	600	400	125	500	51	60	75	161	145	59	M45	253	246	13,6	68,4	FL328	UC328	UCFL328

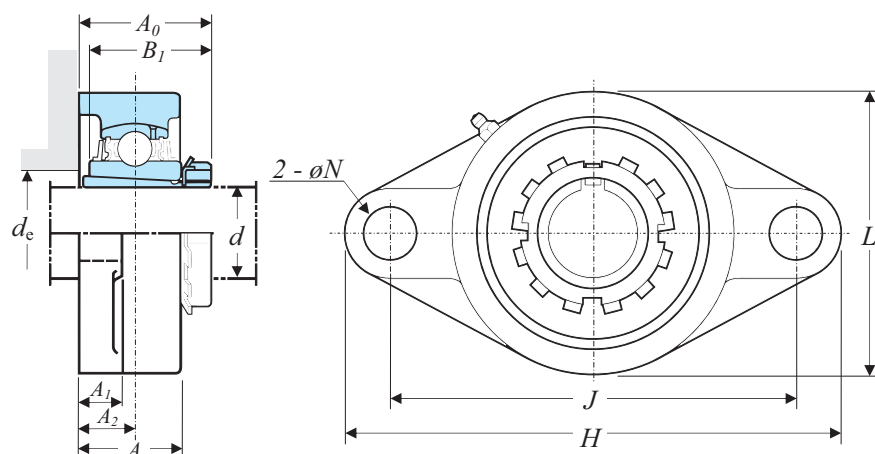

## BEARING UNITS

### Oval Flange Type unit

### UKFL

Table 83

Bore Diameter  
20mm – 125mm

Principal Dimension										Bolt Size	Basic Load Ratings		Fact	Mass	Designations				
d	H	L	A	J	N	A1	A2	Ao	B1		de	Cr			Cor	f0		Housing No	Bearing No
mm											mm	kN		kg					
20	130	68	27	99	16	13	16	34,5	29	30	M14	14	7,85	13,9	0,68	FL205	UK205	UKFL205	H305X
	141	83	30	117	12	13	18	37,5	35	30	M10	19,5	11,3	13,9	1	FLX05	UKX05	UKFLX05	H2305X
	150	80	29	113	19	13	16	37,5	35	-	M16	21,2	10,9	12,6	1,1	FL305	UK305	UKFL305	H2305X
25	148	80	31	117	16	13	18	37,5	31	36	M14	19,5	11,3	13,9	0,97	FL206	UK206	UKFL206	H306X
	156	95	34	130	16	14	19	40	38	36	M14	25,7	15,4	13,9	1,5	FLX06	UKX06	UKFLX06	H2306X
	180	90	32	134	23	15	18	41	38	-	M20	26,7	15	13,3	1,5	FL306	UK306	UKFL306	H2306X
30	161	90	34	130	16	14	19	41	35	41	M14	25,7	15,4	13,9	1,3	FL207	UK207	UKFL207	H307X
	171	105	38	144	16	14	21	43,5	43	41	M14	29,1	17,8	14	1,8	FLX07	UKX07	UKFLX07	H2307X
	185	100	36	141	23	16	20	45,5	43	-	M20	33,4	19,3	13,2	1,9	FL307	UK307	UKFL307	H2307X
35	175	100	36	144	16	14	21	44,5	36	46	M14	29,1	17,8	14	1,6	FL208	UK208	UKFL208	H308X
	179	111	40	148	16	14	22	46,5	46	46	M14	34,1	21,3	14	2,1	FLX08	UKX08	UKFLX08	H2308X
	200	112	40	158	23	17	23	50,5	46	-	M20	40,7	24	13,2	2,5	FL308	UK308	UKFL308	H2308X
40	188	108	38	148	19	15	22	47,5	39	52	M16	34,1	21,3	14	2	FL209	UK209	UKFL209	H309X
	189	116	40	157	16	14	23	48,5	50	52	M14	35,1	23,3	14,4	2,5	FLX09	UKX09	UKFLX09	H2309X
	230	125	44	177	25	18	25	55	50	-	M22	48,9	29,5	13,3	3,6	FL309	UK309	UKFL309	H2309X
45	197	115	40	157	19	15	22	48,5	42	58	M16	35,1	23,3	14,4	2,3	FL210	UK210	UKFL210	H310X
	216	133	44	184	19	20	26	53,5	55	58	M16	43,4	29,4	14,4	3,7	FLX10	UKX10	UKFLX10	H2310X
	240	140	48	187	25	19	28	60	55	-	M22	62	38,3	13,2	4,4	FL310	UK310	UKFL310	H2310X
50	224	130	43	184	19	18	25	52,5	45	64	M16	43,4	29,4	14,4	3,3	FL211	UK211	UKFL211	H311X
	250	150	52	198	25	20	30	63,5	59	-	M22	71,6	45	13,2	5,6	FL311	UK311	UKFL311	H2311X
55	250	140	48	202	23	18	29	58,5	47	69	M20	52,4	36,2	14,4	4,1	FL212	UK212	UKFL212	H312X
	270	160	56	212	31	22	33	69,5	62	-	M27	81,9	52,2	13,2	6,9	FL312	UK312	UKFL312	H2312X
60	258	155	50	210	23	20	30	62	50	74	M20	57,2	40,1	14,4	5	FL213	UK213	UKFL213	H313X
	295	175	58	240	31	25	33	71,5	65	-	M27	92,7	59,9	13,2	8,6	FL313	UK313	UKFL313	H2313X
65	275	165	56	225	23	20	34	69	55	85	M20	67,4	48,3	14,5	6,6	FL215	UK215	UKFL215	H315X
	320	195	66	260	35	30	39	81,5	73	-	M30	113	77,2	13,2	11,4	FL315	UK315	UKFL315	H2315X
70	290	180	58	233	25	20	34	72	59	90	M22	72,7	53	14,6	8,1	FL216	UK216	UKFL216	H316X
	355	210	68	285	38	32	38	82,5	78	-	M33	123	86,7	13,3	13,9	FL316	UK316	UKFL316	H2316X
75	305	190	63	248	25	22	36	76	63	96	M22	84	61,9	14,5	9,9	FL217	UK217	UKFL217	H317X
	370	220	74	300	38	32	44	92	82	-	M33	133	96,8	13,3	15,8	FL317	UK317	UKFL317	H2317X
80	320	205	68	265	25	23	40	82	65	102	M22	96,1	71,5	14,5	12,2	FL218	UK218	UKFL218	H318X
	385	235	76	315	38	36	44	92	86	-	M33	143	107	13,3	19,1	FL318	UK318	UKFL318	H2318X
85	405	250	94	330	41	40	59	111	90	-	M36	153	119	13,3	24,9	FL319	UK319	UKFL319	H2319X
90	440	270	94	360	44	40	59	113	97	-	M39	173	141	13,2	29	FL320	UK320	UKFL320	H2320X
100	470	300	96	390	44	42	60	120	105	-	M39	205	180	13,2	36,1	FL322	UK322	UKFL322	H2322X
110	520	330	110	430	47	48	65	130,5	112	-	M42	207	185	13,5	51,9	FL324	UK324	UKFL324	H2324
115	550	360	115	460	47	50	65	131,5	121	-	M42	229	214	13,6	61,4	FL326	UK326	UKFL326	H2326
125	600	400	125	500	51	60	75	147,5	131	-	M45	253	246	13,6	68,4	FL328	UK328	UKFL328	H2328

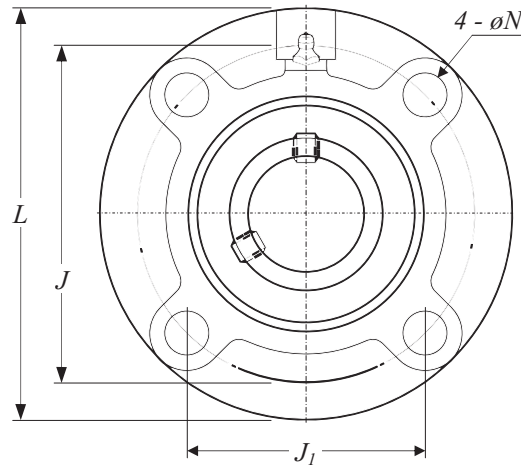
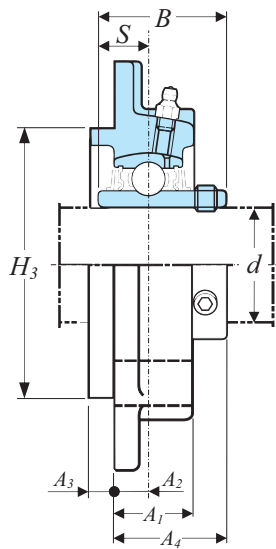

## BEARING UNITS

### Round Flange Cartridge Type Units, UCFC

Table 84

 Bore Diameter  
12mm – 100mm

Principal Dimension												Bolt Size	Basic Load Ratings		Fact f <sub>0</sub>	Mass kg	Designations		
d	L	H <sub>2</sub>	J	J <sub>1</sub>	N	A <sub>1</sub>	A <sub>2</sub>	A <sub>3</sub>	A <sub>4</sub>	B	S		Cr	Cor			Housing No	Bearing No	Unit No
mm																			
12	100	62	78	55,1	12	20,5	10	5	28,3	31	12,7	M10	12,8	6,65	13,2	0,78	FC204	UC201	UCFC201
15	100	62	78	55,1	12	20,5	10	5	28,3	31	12,7	M10	12,8	6,65	13,2	0,76	FC204	UC202	UCFC202
17	100	62	78	55,1	12	20,5	10	5	28,3	31	12,7	M10	12,8	6,65	13,2	0,75	FC204	UC203	UCFC203
20	100	62	78	55,1	12	20,5	10	5	28,3	31	12,7	M10	12,8	6,65	13,2	0,73	FC204	UC204	UCFC204
25	115	70	90	63,6	12	21	10	6	29,8	34,1	14,3	M10	14	7,85	13,9	0,95	FC205	UC205	UCFC205
	111	76	92	65	9,5	24	10	6	32,2	38,1	15,9	M8	19,5	11,3	13,9	1,2	FCX05	UCX05	UCFCX05
30	125	80	100	70,7	12	23	10	8	32,2	38,1	15,9	M10	19,5	11,3	13,9	1,3	FC206	UC206	UCFC206
	127	85	105	74,2	12	22,5	8	9,5	33,4	42,9	17,5	M10	25,7	15,4	13,9	1,5	FCX06	UCX06	UCFCX06
35	135	90	110	77,8	14	26	11	8	36,4	42,9	17,5	M12	25,7	15,4	13,9	1,7	FC207	UC207	UCFC207
	133	92	111	78,5	12	26	9	11	39,2	49,2	19	M10	34,1	21,3	14	2	FCX07	UCX07	UCFCX07
40	145	100	120	84,8	14	26	11	10	41,2	49,2	19	M12	29,1	17,8	14	2	FC208	UC208	UCFC208
	133	92	111	78,5	12	26	9	11	39,2	49,2	19	M10	34,1	21,3	14	2	FCX08	UCX08	UCFCX08
45	160	105	132	93,3	16	26	10	12	40,2	49,2	19	M14	34,1	21,3	14	2,6	FC209	UC209	UCFC209
	155	108	130	91,9	14	25	8	12	40,6	51,6	19	M12	35,1	23,3	14,4	2,6	FCX09	UCX09	UCFCX09
50	165	110	138	97,6	16	28	10	12	42,6	51,6	19	M14	35,1	23,3	14,4	2,9	FC210	UC210	UCFC210
	162	118	136	96,2	14	25	7	16	40,4	55,6	22,2	M12	43,4	29,4	14,4	3,2	FCX10	UCX10	UCFCX10
55	185	125	150	106,1	19	31	13	12	46,4	55,6	22,2	M16	43,4	29,4	14,4	4,2	FC211	UC211	UCFC211
	180	127	152	107,5	16	26	4	22	43,7	65,1	25,4	M14	52,4	36,2	14,4	4,3	FCX11	UCX11	UCFCX11
60	195	135	160	113,1	19	36	17	12	56,7	65,1	25,4	M16	52,4	36,2	14,4	5	FC212	UC212	UCFC212
	194	140	165	116,7	16	33	11	20	50,7	65,1	25,4	M14	57,2	40,1	14,4	5,3	FCX12	UCX12	UCFCX12
65	205	145	170	120,2	19	36	16	14	55,7	65,1	25,4	M16	57,2	40,1	14,4	5,6	FC213	UC213	UCFC213
	194	140	165	116,7	16	33	11	20	55,4	74,6	30,2	M14	62,2	44,1	14,5	5,7	FCX13	UCX13	UCFCX13
70	215	150	177	125,1	19	40	17	14	61,4	74,6	30,2	M16	62,2	44,1	14,5	6,8	FC214	UC214	UCFC214
	222	164	190	134,3	19	36	14	20	58,5	77,8	33,3	M16	67,4	48,3	14,5	7,3	FCX14	UCX14	UCFCX14
75	220	160	184	130,1	19	40	18	16	62,5	77,8	33,3	M16	67,4	48,3	14,5	7,2	FC215	UC215	UCFC215
	222	164	190	134,3	19	35	12	22	61,3	82,6	33,3	M16	72,7	53	14,6	8	FCX15	UCX15	UCFCX15
80	240	170	200	141,4	23	42	18	16	67,3	82,6	33,3	M20	72,7	53	14,6	8,7	FC216	UC216	UCFC216
	260	186	219	154,8	23	36	10	25	61,6	85,7	34,1	M20	84	61,9	14,5	11,3	FCX16	UCX16	UCFCX16
85	250	180	208	147,1	23	45	18	18	69,6	85,7	34,1	M20	84	61,9	14,5	10,3	FC217	UC217	UCFC217
	260	186	219	154,8	23	36	10	25	66,3	96	39,7	M20	96,1	71,5	14,5	12,9	FCX17	UCX17	UCFCX17
90	265	190	220	155,5	23	50	22	18	78,3	96	39,7	M20	96,1	71,5	14,5	13,3	FC218	UC218	UCFC218
	260	186	219	154,8	23	43	12	28	73,1	104	42,9	M20	109	81,9	14,4	13,5	FCX18	UCX18	UCFCX18
100	276	206	238	168,3	23	66	22	28	90,3	118	49,2	M20	133	105	14,4	18,2	FCX20	UCX20	UCFCX20

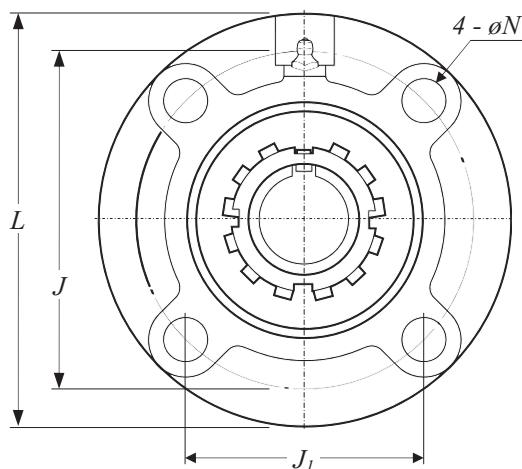
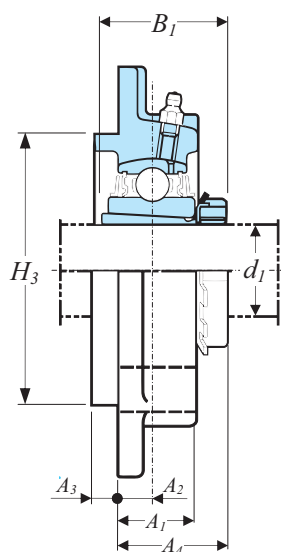

**BEARING UNITS**  
Round Flange Cartridge  
Type Units, UKFC

Table 85

Bore Diameter  
20mm – 75mm

Principal Dimension											Bolt Size	Basic Load Ratings		Fact f <sub>0</sub>	Mass kg	Designations		
d <sub>1</sub> mm	L	H <sub>3</sub>	J	J <sub>1</sub>	N	A <sub>1</sub>	A <sub>2</sub>	A <sub>3</sub>	A <sub>4</sub>	B <sub>1</sub>		Cr kN	Cor			Housing No	Bearing No	Unit No
20	115	70	90	63,6	12	21	10	6	28,5	29	M10	14	7,85	13,9	0,99	FC205	UK205	UKFC205
	111	76	92	65	9,5	24	10	6	29,5	35	M8	19,5	11,3	13,9	1,2	FCX05	UKX05	UKFCX05
25	125	80	100	70,7	12	23	10	8	29,5	31	M10	19,5	11,3	13,9	1,3	FC206	UK206	UKFC206
	127	85	105	74,2	12	22,5	8	9,5	29	38	M10	25,7	15,4	13,9	1,5	FCX06	UKX06	UKFCX06
30	135	90	110	77,8	14	26	11	8	33	35	M12	25,7	15,4	13,9	1,7	FC207	UK207	UKFC207
	133	92	111	78,5	12	26	9	11	31,5	43	M10	29,1	17,8	14	1,9	FCX07	UKX07	UKFCX07
35	145	100	120	84,8	14	26	11	10	34,5	36	M12	29,1	17,8	14	2	FC208	UK208	UKFC208
	133	92	111	78,5	12	26	9	11	33,5	46	M10	34,1	21,3	14	1,9	FCX08	UKX08	UKFCX08
40	160	105	132	93,3	16	26	10	12	35,5	39	M14	34,1	21,3	14	2,7	FC209	UK209	UKFC209
	155	108	130	91,9	14	25	8	12	33,5	50	M12	35,1	23,3	14,4	2,6	FCX09	UKX09	UKFCX09
45	165	110	138	97,6	16	28	10	12	36,5	42	M14	35,1	23,3	14,4	3	FC210	UK210	UKFC210
	162	118	136	96,2	14	25	7	16	34,5	55	M12	43,4	29,4	14,4	3,1	FCX10	UKX10	UKFCX10
50	185	125	150	106,1	19	31	13	12	40,5	45	M16	43,4	29,4	14,4	4,3	FC211	UK211	UKFC211
	180	127	152	107,5	16	26	4	22	32,5	59	M14	52,4	36,2	14,4	4	FCX11	UKX11	UKFCX11
55	195	135	160	113,1	19	36	17	12	46,5	47	M16	52,4	36,2	14,4	4,9	FC212	UK212	UKFC212
	194	140	165	116,7	16	33	11	20	42	62	M14	57,2	40,1	14,4	5,1	FCX12	UKX12	UKFCX12
60	205	145	170	120,2	19	36	16	14	48	50	M16	57,2	40,1	14,4	5,5	FC213	UK213	UKFC213
	194	140	165	116,7	16	33	11	20	45	65	M14	62,2	44,1	14,5	5,3	FCX13	UKX13	UKFCX13
65	220	160	184	130,1	19	40	18	16	53	55	M16	67,4	48,3	14,5	7,4	FC215	UK215	UKFC215
	222	164	190	134,3	19	35	12	22	48	73	M16	72,7	53	14,6	7,7	FCX15	UKX15	UKFCX15
70	240	170	200	141,4	23	42	18	16	56	59	M20	72,7	53	14,6	9	FC216	UK216	UKFC216
	260	186	219	154,8	23	36	10	25	49	78	M20	84	61,9	14,5	11,4	FCX16	UKX16	UKFCX16
75	250	180	208	147,1	23	45	18	18	58	63	M20	84	61,9	14,5	10,4	FC217	UK217	UKFC217
	260	186	219	154,8	23	36	10	25	52	82	M20	96,1	71,5	14,5	12,6	FCX17	UKX17	UKFCX17

## BEARING UNITS

### Take Up Type Units, UCT

Table 86

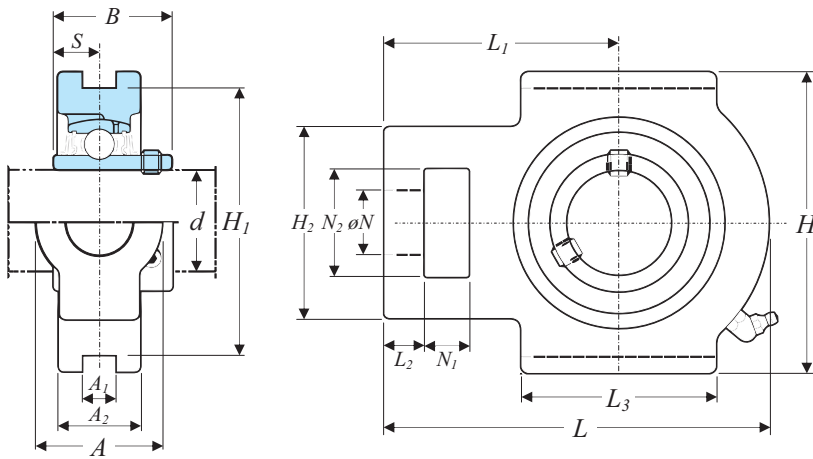
 Bore Diameter  
12mm – 140mm

Principal Dimension																	Basic Load Ratings		Mass	Designations		
d1	A	A1	A2	H	H1	H2	L	L1	L2	L3	N	N1	N2	B	S	Cr	Cor	kg		Housing No	Bearing No	Unit No
mm																Dynamic	Static					
																	kN	kN				
12	32	12	21	89	76	51	94	61	10	51	19	16	32	31	12,7	12,8	6,65	0,81	T204	UC201	UCT201	
15	32	12	21	89	76	51	94	61	10	51	19	16	32	31	12,7	12,8	6,65	0,79	T204	UC202	UCT202	
17	32	12	21	89	76	51	94	61	10	51	19	16	32	31	12,7	12,8	6,65	0,78	T204	UC203	UCT203	
20	32	12	21	89	76	51	94	61	10	51	19	16	32	31	12,7	12,8	6,65	0,76	T204	UC204	UCT204	
25	32	12	24	89	76	51	97	62	10	51	19	16	32	34,1	14,3	14	7,85	0,84	T205	UC205	UCT205	
	37	12	28	102	89	56	113	70	10	57	22	16	37	38,1	15,9	19,5	11,3	1,4	TX05	UCX05	UCTX05	
	36	12	26	89	80	62	122	76	12	65	26	16	36	38	15	21,2	10,9	1,4	T305	UC305	UCT305	
30	37	12	28	102	89	56	113	70	10	57	22	16	37	38,1	15,9	19,5	11,3	1,3	T206	UC206	UCT206	
	37	12	30	102	89	64	129	78	13	64	22	16	37	42,9	17,5	25,7	15,4	1,7	TX06	UCX06	UCTX06	
	41	16	28	100	90	70	137	85	14	74	28	18	41	43	17	26,7	15	1,8	T306	UC306	UCT306	
35	37	12	30	102	89	64	129	78	13	64	22	16	37	42,9	17,5	25,7	15,4	1,6	T207	UC207	UCT207	
	49	16	36	114	102	83	144	88	15	83	29	19	49	49,2	19	29,1	17,8	2,7	TX07	UCX07	UCTX07	
	45	16	32	111	100	75	150	94	15	80	30	20	45	48	19	33,4	19,3	2,3	T307	UC307	UCT307	
40	49	16	33	114	102	83	144	88	16	83	29	19	49	49,2	19	29,1	17,8	2,5	T208	UC208	UCT208	
	49	16	36	117	102	83	144	87	15	83	29	19	49	49,2	19	34,1	21,3	2,6	TX08	UCX08	UCTX08	
	50	18	34	124	112	83	162	100	17	89	32	22	50	52	19	40,7	24	3	T308	UC308	UCT308	
45	49	16	35	117	102	83	144	87	16	83	29	19	49	49,2	19	34,1	21,3	2,4	T209	UC209	UCT209	
	49	16	38	117	102	83	149	90	16	86	29	19	49	51,6	19	35,1	23,3	2,9	TX09	UCX09	UCTX09	
	55	18	38	138	125	90	178	110	18	97	34	24	55	57	22	48,9	29,5	4,1	T309	UC309	UCT309	
50	49	16	37	117	102	83	149	90	16	86	29	19	49	51,6	19	35,1	23,3	2,6	T210	UC210	UCT210	
	64	22	42	146	130	102	171	106	19	95	35	25	64	55,6	22,2	43,4	29,4	4,4	TX10	UCX10	UCTX10	
	61	20	40	151	140	98	191	117	20	106	37	27	61	61	22	62	38,3	4,9	T310	UC310	UCT310	
55	64	22	38	146	130	102	171	106	19	95	35	25	64	55,6	22,2	43,4	29,4	4	T211	UC211	UCT211	
	64	22	44	146	130	102	194	119	19	102	35	32	64	65,1	25,4	52,4	36,2	5,3	TX11	UCX11	UCTX11	
	66	22	44	163	150	105	207	127	21	115	39	29	66	66	25	71,6	45	6,1	T311	UC311	UCT311	
60	64	22	42	146	130	102	194	119	19	102	35	32	64	65,1	25,4	52,4	36,2	4,9	T212	UC212	UCT212	
	70	26	48	167	151	111	224	137	21	121	41	32	70	65,1	25,4	57,2	40,1	7,4	TX12	UCX12	UCTX12	
	71	22	46	178	160	113	220	135	23	123	41	31	71	71	26	81,9	52,2	7,6	T312	UC312	UCT312	
65	70	26	44	167	151	111	224	137	21	121	41	32	70	65,1	25,4	57,2	40,1	6,9	T213	UC213	UCT213	
	70	26	48	167	151	111	224	137	21	121	41	32	70	74,6	30,2	62,2	44,1	7,6	TX13	UCX13	UCTX13	
	80	26	50	190	170	116	238	146	25	134	43	32	70	75	30	92,7	59,9	9,3	T313	UC313	UCT313	
70	70	26	46	167	151	111	224	137	21	121	41	32	70	74,6	30,2	62,2	44,1	7	T214	UC214	UCT214	
	70	26	48	167	151	111	232	140	21	121	41	32	70	77,8	33,3	67,4	48,3	7,9	TX14	UCX14	UCTX14	
	90	26	52	202	180	130	252	155	25	140	46	36	85	78	33	104	68,2	11,1	T314	UC314	UCT314	
75	70	26	48	167	151	111	232	140	21	121	41	32	70	77,8	33,3	67,4	48,3	7,3	T215	UC215	UCT215	
	70	28	48	184	165	111	235	140	21	121	41	32	70	82,6	33,3	72,7	53	8,7	TX15	UCX15	UCTX15	
	90	26	55	216	192	132	262	160	25	150	46	36	85	82	32	113	77,2	13	T315	UC315	UCT315	
80	70	26	51	184	165	111	235	140	21	121	41	32	70	82,6	33,3	72,7	53	8,2	T216	UC216	UCT216	
	73	28	54	198	173	124	260	162	28	157	48	38	73	85,7	34,1	84	61,9	11,7	TX16	UCX16	UCTX16	
	102	30	60	230	204	150	282	174	28	160	53	42	98	86	34	123	86,7	16,2	T316	UC316	UCT316	
85	73	30	54	198	173	124	260	162	29	157	48	38	73	85,7	34,1	84	61,9	11	T217	UC217	UCT217	
	73	28	54	198	173	124	260	162	28	157	48	38	73	96	39,7	96,1	71,5	11,7	TX17	UCX17	UCTX17	
	102	32	64	240	214	152	298	183	30	170	53	42	98	96	40	133	96,8	19	T317	UC317	UCT317	
90	110	32	66	255	228	160	312	192	30	175	57	46	106	96	40	143	107	21,6	T318	UC318	UCT318	
95	110	35	72	270	240	165	322	197	31	180	57	46	106	103	41	153	119	24,9	T319	UC319	UCT319	
100	120	35	75	290	260	175	345	210	32	200	59	48	115	108	42	173	141	30,7	T320	UC320	UCT320	
105	120	35	75	290	260	175	345	210	32	200	59	48	115	112	44	184	153	36,7	T321	UC321	UCT321	
110	130	38	80	320	285	185	385	235	38	215	65	52	125	117	46	205	180	39,7	T322	UC322	UCT322	
120	140	45	90	355	320	210	432	267	42	230	70	60	140	126	51	207	185	54,4	T324	UC324	UCT324	
130	150	50	100	385	350	220	465	285	45	240	75	65	150	135	54	229	214	69,3	T326	UC326	UCT326	
140	155	50	100	415	380	230	515	315	50	255	80	70	160	145	59	253	246	85,1	T328	UC328	UCT328	

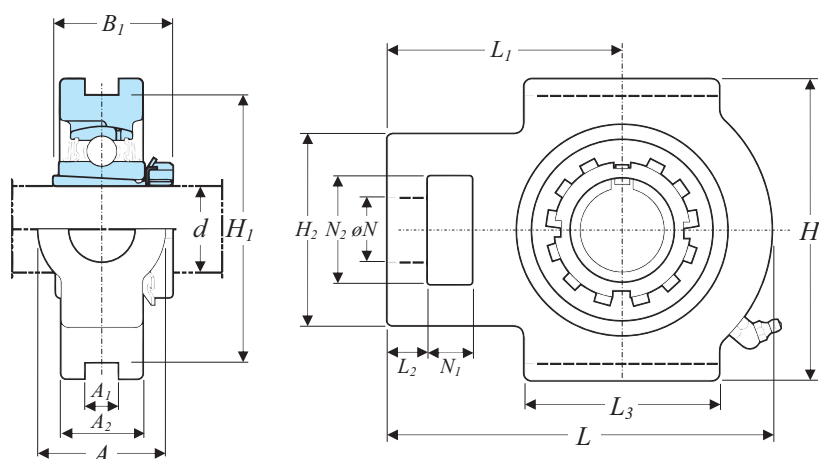

## BEARING UNITS

### Take Up Type Units, UKT

Table 87

 Bore Diameter  
20mm – 125mm

Principal Dimension														Basic Load Ratings		Mass	Designations			
d1	A	A1	A2	H	H1	H2	L	L1	L2	L3	N	N1	N2	B1	Cr		Cor	kg	Housing No	Bearing No
mm														Dynamic	Static					
													kN							
20	32	12	24	89	76	51	97	62	10	51	19	16	32	29	14	7,85	0,88	T205	UK205	UKT205
	37	12	28	102	89	56	113	70	10	57	22	16	37	35	19,5	11,3	1,3	TX05	UKX05	UKTX05
	36	12	26	89	80	62	122	76	12	65	26	16	36	35	21,2	10,9	1,5	T305	UK305	UKT305
25	37	12	28	102	89	56	113	70	10	57	22	16	37	31	19,5	11,3	1,3	T206	UK206	UKT206
	37	12	30	102	89	64	129	78	13	64	22	16	37	38	25,7	15,4	1,7	TX06	UKX06	UKTX06
	41	16	28	100	90	70	137	85	14	74	28	18	41	38	26,7	15	1,9	T306	UK306	UKT306
30	37	12	30	102	89	64	129	78	13	64	22	16	37	35	25,7	15,4	1,7	T207	UK207	UKT207
	49	16	36	114	102	83	144	88	15	83	29	19	49	43	29,1	17,8	2,6	TX07	UKX07	UKTX07
	45	16	32	111	100	75	150	94	15	80	30	20	45	43	33,4	19,3	2,4	T307	UK307	UKT307
35	49	16	33	114	102	83	144	88	16	83	29	19	49	36	29,1	17,8	2,5	T208	UK208	UKT208
	49	16	36	117	102	83	144	87	15	83	29	19	49	46	34,1	21,3	2,6	TX08	UKX08	UKTX08
	50	18	34	124	112	83	162	100	17	89	32	22	50	46	40,7	24	3	T308	UK308	UKT308
40	49	16	35	117	102	83	144	87	16	83	29	19	49	39	34,1	21,3	2,5	T209	UK209	UKT209
	49	16	38	117	102	83	149	90	16	86	29	19	49	50	35,1	23,3	2,9	TX09	UKX09	UKTX09
	55	18	38	138	125	90	178	110	18	97	34	24	55	50	48,9	29,5	4,2	T309	UK309	UKT309
45	49	16	37	117	102	83	149	90	16	86	29	19	49	42	35,1	23,3	2,7	T210	UK210	UKT210
	64	22	42	146	130	102	171	106	19	95	35	25	64	55	43,4	29,4	4,4	TX10	UKX10	UKTX10
	61	20	40	151	140	98	191	117	20	106	37	27	61	55	62	38,3	5	T310	UK310	UKT310
50	64	22	38	146	130	102	171	106	19	95	35	25	64	45	43,4	29,4	4,1	T211	UK211	UKT211
	64	22	44	146	130	102	194	119	19	102	35	32	64	59	52,4	36,2	5,1	TX11	UKX11	UKTX11
	66	22	44	163	150	105	207	127	21	115	39	29	66	59	71,6	45	6,4	T311	UK311	UKT311
55	64	22	42	146	130	102	194	119	19	102	35	32	64	47	52,4	36,2	4,8	T212	UK212	UKT212
	70	26	48	167	151	111	224	137	21	121	41	32	70	62	57,2	40,1	7,3	TX12	UKX12	UKTX12
	71	22	46	178	160	113	220	135	23	123	41	31	71	62	81,9	52,2	7,5	T312	UK312	UKT312
60	70	26	44	167	151	111	224	137	21	121	41	32	70	50	57,2	40,1	6,8	T213	UK213	UKT213
	70	26	48	167	151	111	224	137	21	121	41	32	70	65	62,2	44,1	7,2	TX13	UKX13	UKTX13
	80	26	50	190	170	116	238	146	25	134	43	32	70	65	92,7	59,9	9,4	T313	UK313	UKT313
65	70	26	48	167	151	111	232	140	21	121	41	32	70	55	67,4	48,3	7,4	T215	UK215	UKT215
	70	28	48	184	165	111	235	140	21	121	41	32	70	73	72,7	53	8,4	TX15	UKX15	UKTX15
	90	26	55	216	192	132	262	160	25	150	46	36	85	73	113	77,2	13,1	T315	UK315	UKT315
70	70	26	51	184	165	111	235	140	21	121	41	32	70	59	72,7	53	8,5	T216	UK216	UKT216
	73	28	54	198	173	124	260	162	28	157	48	38	73	78	84	61,9	11,8	TX16	UKX16	UKTX16
	102	30	60	230	204	150	282	174	28	160	53	42	98	78	123	86,7	16,3	T316	UK316	UKT316
75	73	30	54	198	173	124	260	162	29	157	48	38	73	63	84	61,9	11,2	T217	UK217	UKT217
	73	28	54	198	173	124	260	162	28	157	48	38	73	82	96,1	71,5	11,4	TX17	UKX17	UKTX17
	102	32	64	240	214	152	298	183	30	170	53	42	98	82	133	96,8	18,9	T317	UK317	UKT317
80	110	32	66	255	228	160	312	192	30	175	57	46	106	86	143	107	21,7	T318	UK318	UKT318
85	110	35	72	270	240	165	322	197	31	180	57	46	106	90	153	119	25,2	T319	UK319	UKT319
90	120	35	75	290	260	175	345	210	32	200	59	48	115	97	173	141	30,4	T320	UK320	UKT320
100	130	38	80	320	285	185	385	235	38	215	65	52	125	105	205	180	39,5	T322	UK322	UKT322
110	140	45	90	355	320	210	432	267	42	230	70	60	140	112	207	185	54,7	T324	UK324	UKT324
115	150	50	100	385	350	220	465	285	45	240	75	65	150	121	229	214	69,1	T326	UK326	UKT326
125	155	50	100	415	380	230	515	315	50	255	80	70	160	131	253	246	85,1	T328	UK328	UKT328

**BALL BEARING INSERTS**  
 UC, SB, SU Series

Table 88

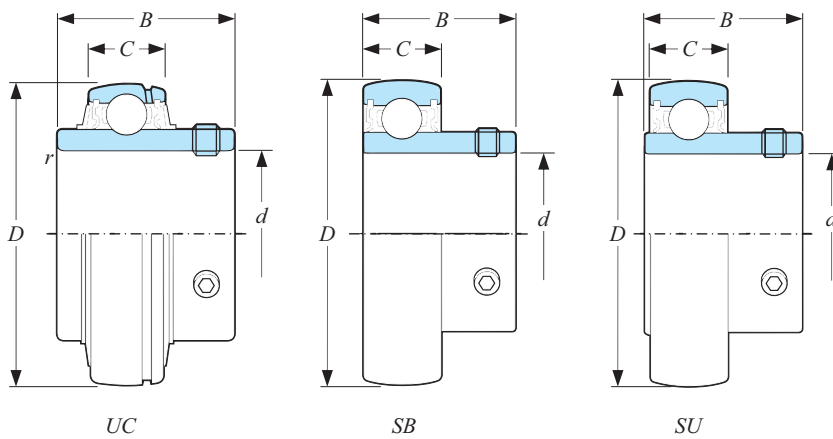
 Bore Diameter  
 12mm – 70mm

Principal Dimension					Basic Load Ratings		Factor	Mass	Designation
d	D	B	C	r (min)	Cr	Cor			
mm					kN		f <sub>0</sub>	kg	Bearing No
12	40	22	12	-	9,55	4,8	13,2	0,1	SB201
	47	31	16	0,6	12,8	6,65	13,2	0,21	UC201
15	40	22	12	-	9,55	4,8	13,2	0,1	SB202
	47	31	16	0,6	12,8	6,65	13,2	0,19	UC202
17	40	22	12	-	9,55	4,8	13,2	0,1	SB203
	47	31	16	0,6	12,8	6,65	13,2	0,18	UC 203
20	47	25	14	-	12,8	6,65	13,2	0,15	SB204
	47	31	16	1	12,8	6,65	13,2	0,16	UC 204
25	52	27	15	-	14	7,85	13,9	0,18	SB205
	52	34,1	17	1	14	7,85	13,9	0,2	UC 205
	62	38	22	1,1	21,2	10,9	12,6	0,45	UC 305
30	62	38,1	19	1	19,5	11,3	13,9	0,39	UCX05
	62	30	16	-	19,5	11,3	13,9	0,27	SB206
	62	38,1	19	1	19,5	11,3	13,9	0,32	UC206
35	72	42,9	20	1	25,7	15,4	13,9	0,58	UCX06
	72	43	24	1,1	26,7	15	13,3	0,56	UC306
	72	32	17	-	25,7	15,4	13,9	0,42	SB207
40	80	48	26	1,5	33,4	19,3	13,2	0,71	UC 307
	80	49,2	21	1,1	29,1	17,8	14	0,75	UCX07
	80	34	18	-	29,1	17,8	14	0,6	SB208
45	85	49,2	22	1,1	34,1	21,3	14	0,83	UCX08
	90	52	28	1,5	40,7	24	13,2	1	UC 308
	85	49,2	22	1,1	34,1	21,3	14	0,68	UC 209
50	90	51,6	24	1,1	35,1	23,3	14,4	0,95	UCX09
	100	57	30	1,5	48,9	29,5	13,3	1,33	UC309
	90	51,6	24	1,1	35,1	23,3	14,4	0,8	UC210
55	100	55,6	25	1,1	43,4	29,4	14,4	1,29	UCX10
	110	61	32	2	62	38,3	13,2	1,69	UC310
	100	55,6	25	1,5	43,4	29,4	14,4	1,11	UC211
60	110	65,1	27	1,5	52,4	36,2	14,4	1,8	UCX11
	120	66	34	2	71,6	45	13,2	1,9	UC311
	110	65,1	27	1,5	52,4	36,2	14,4	1,54	UC212
65	120	65,1	28	1,5	57,2	40,1	14,4	2,05	UCX12
	130	71	36	2,1	81,9	52,2	13,2	2,6	UC312
	120	65,1	28	1,5	57,2	40,1	14,4	1,86	UC213
70	125	74,6	30	1,5	62,2	44,1	14,5	2,52	UCX13
	140	75	38	2,1	92,7	59,9	13,2	3,16	UC313
	125	74,6	30	1,5	62,2	44,1	14,5	2,05	UC214
75	130	77,8	32	1,5	67,4	48,3	14,5	2,74	UCX14
	150	78	40	2,1	104	68,2	13,2	3,9	UC314

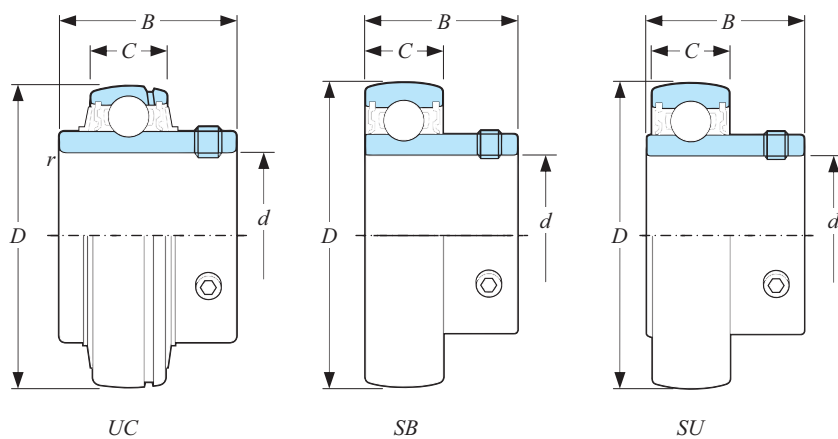

### BALL BEARING INSERTS UC, SB, SU Series

Table 89

Bore Diameter  
75mm – 140mm

Principal Dimension					Basic Load Ratings		Factor	Mass	Designation
d	D	B	C	r (min)	Dynamic	Static			
mm					Cr	Cor	f <sub>0</sub>	kg	Bearing No
75	130	77,8	32	1,5	67,4	48,3	14,5	2,21	UC215
	140	82,6	33	1,5	72,7	53	14,6	3,41	UCX15
	160	82	42	2,1	113	77,2	13,2	4,7	UC315
80	140	82,6	33	2	72,7	53	14,6	2,79	UC216
	150	85,7	35	2	84	61,9	14,5	3,87	UCX16
	170	86	44	2,1	123	86,7	13,3	5,6	UC316
85	150	85,7	35	2	84	61,9	14,5	3,45	UC217
	160	96	38	2	96,1	71,5	14,5	5,05	UCX17
	180	96	46	3	133	96,8	13,3	6,9	UC317
90	160	96	38	2	96,1	71,5	14,5	4,35	UC 218
	190	96	48	3	143	107	13,3	7,87	UC 318
95	200	103	50	3	153	119	13,3	8,91	UC 319
100	190	117,5	43	2,1	133	105	14,4	8,56	UCX20
	215	108	54	3	173	141	13,2	11,2	UC 320
105	225	112	56	3	184	153	13,2	12,7	UC 321
110	240	117	60	3	205	180	13,2	15,1	UC 322
120	260	126	64	3	207	185	13,5	19	UC 324
130	280	135	68	4	229	214	13,6	23,6	UC 326
140	300	145	72	4	253	246	13,6	29,4	UC 328





**BALL BEARING INSERTS**  
 UK Series

Table 90

 Bore Diameter  
 25mm – 140mm

Principal Dimension				Basic Load Ratings		Factor	Mass	Designation
d	D	B	C	Cr	Cor			
mm				kN		f <sub>0</sub>	kg	Bearing No
25	52	21	17	14	7,85	13,9	0,16	UK205
25	62	23	19	19,5	11,3	13,9	0,27	UKX05
25	62	27	22	21,2	10,9	12,6	0,4	UK305
30	62	23	19	19,5	11,3	13,9	0,25	UK206
30	72	26	20	25,7	15,4	13,9	0,43	UKX06
30	72	30	24	26,7	15	13,3	0,47	UK306
35	72	26	20	25,7	15,4	13,9	0,37	UK207
35	80	27	21	29,1	17,8	14	0,53	UKX07
35	80	33	26	33,4	19,3	13,2	0,6	UK307
40	80	27	21	29,1	17,8	14	0,47	UK208
40	85	29	22	34,1	21,3	14	0,58	UKX08
40	90	35	28	40,7	24	13,2	0,8	UK308
45	85	29	22	34,1	21,3	14	0,52	UK209
45	90	29	24	35,1	23,3	14,4	0,67	UKX09
45	100	38	30	48,9	29,5	13,3	1,08	UK309
50	90	29	24	35,1	23,3	14,4	0,59	UK210
50	100	31	25	43,4	29,4	14,4	0,89	UKX10
50	110	40	32	62	38,3	13,2	1,38	UK310
55	100	31	25	43,4	29,4	14,4	0,8	UK211
55	110	33	27	52,4	36,2	14,4	1,15	UKX11
55	120	43	34	71,6	45	13,2	1,78	UK311
60	110	33	27	52,4	36,2	14,4	1,02	UK212
60	120	36	28	57,2	40,1	14,4	1,45	UKX12
60	130	47	36	81,9	52,2	13,2	2,06	UK312
65	120	36	28	57,2	40,1	14,4	1,34	UK213
65	125	40	30	62,2	44,1	14,5	1,62	UKX13
65	140	49	38	92,7	59,9	13,2	2,71	UK313
75	130	40	32	67,4	48,3	14,5	1,5	UK215
75	140	42	33	72,7	53	14,6	2,1	UKX15
75	160	55	42	113	77,2	13,2	3,8	UK315
80	140	42	33	72,7	53	14,6	1,96	UK216
80	150	44	35	84	61,9	14,5	2,64	UKX16
80	170	55	44	123	86,7	13,3	4,39	UK316
85	150	44	35	84	61,9	14,5	2,42	UK217
85	160	48	38	96,1	71,5	14,5	3,25	UKX17
85	180	60	46	133	96,8	13,3	5,3	UK317
90	160	48	38	96,1	71,5	14,5	2,9	UK218
90	170	50	40	109	81,9	14,4	3,8	UKX18
90	190	60	48	143	107	13,3	6,2	UK318
95	200	66	50	153	119	13,3	7,31	UK319
100	190	54	43	133	105	14,4	5,36	UKX20
100	215	68	54	173	141	13,2	8,7	UK320
110	240	78	60	205	180	13,2	12,2	UK322
120	260	87	64	207	185	13,5	16,1	UK324
130	280	87	68	229	214	13,6	18,8	UK326
140	300	97	72	253	246	13,6	23,9	UK328

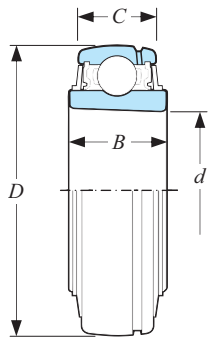
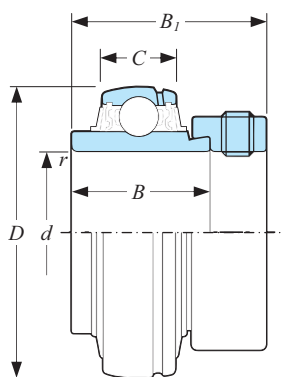

**BALL BEARING INSERTS**  
NA Series

Table 91

Bore Diameter  
20mm – 60mm

Principal Dimension						Basic Load Ratings		Factor	Mass	Designation
d	D	B	B1	C	r (min)	Dynamic	Static			
mm						Cr	Cor	f0	kg	Bearing No
20	47	34,2	43,7	16	1	12,8	6,65	13,2	0,22	NA204
25	52	34,9	44,4	17	1	14	7,85	13,9	0,25	NA205
30	62	36,5	48,4	19	1	19,5	11,3	13,9	0,41	NA206
35	72	37,6	51,1	20	1,1	25,7	15,4	13,9	0,61	NA207
40	80	42,8	56,3	21	1,1	29,1	17,8	14	0,78	NA208
45	85	42,8	56,3	22	1,1	34,1	21,3	14	0,85	NA209
50	90	49,2	62,7	24	1,1	35,1	23,3	14,4	1,01	NA210
55	100	55,5	71,4	25	1,5	43,4	29,4	14,4	1,39	NA211
60	110	61,9	77,8	27	1,5	52,4	36,2	14,4	1,87	NA212

**BALL BEARING INSERTS**  
 ER, RB Series

Table 92

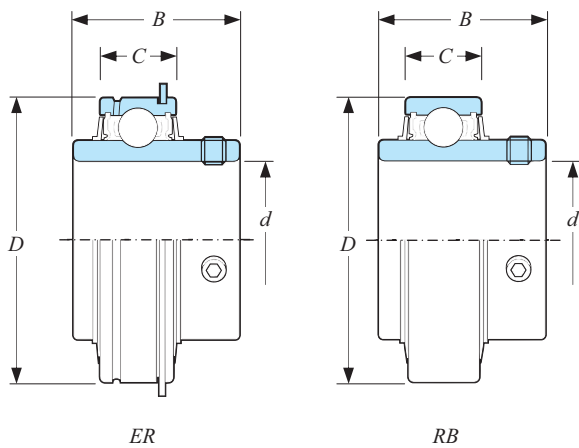
 Bore Diameter  
 12mm – 60mm

Principal Dimension				Basic Load Ratings		Factor	Mass		Designation	
d mm	D	B	C	Dynamic Static			f0	ER kg	RB	ER Series
				Cr kN	Cor					
12	47	31	16	12,8	6,65	13,2	0,22	0,22	ER201	RB201
15	47	31	16	12,8	6,65	13,2	0,22	0,22	ER202	RB202
17	47	31	16	12,8	6,65	13,2	0,22	0,22	ER203	RB203
20	47	31	16	12,8	6,65	13,2	0,22	0,22	ER204	RB204
25	52	34,1	19	14	7,85	13,9	0,27	0,26	ER205	RB205
30	62	38,1	22	19,5	11,3	13,9	0,39	0,38	ER206	RB206
35	72	42,9	24	25,7	15,4	13,9	0,63	0,62	ER207	RB207
40	80	49,2	28	29,1	17,8	14	0,81	0,78	ER208	RB208
45	85	49,2	28	34,1	21,3	14	0,9	-	ER209	-
50	90	51,6	28	35,1	23,3	14,4	0,98	-	ER210	-
55	100	55,6	30	43,4	29,4	14,4	1,41	-	ER211	-
60	110	65,1	32	52,4	36,2	14,4	1,89	-	ER212	-

# APPENDICES CONTENTS

Tolerance Tables for Shaft Diameters  
Tolerance Tables for Housing Bore Diameters

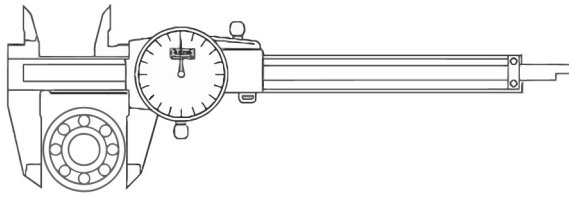

## TOLERANCE TABLES

Tolerances for Shaft Diameters

*units :  $\mu\text{m}$* 

Diameter (mm)		$\Delta_{dmp}$	d6	e6	f6	g5	g6	h5	h6	h7	h8	h9	h10	js5	js6	j5	j6	j7	k5	k6	k7	m5	m6	n6	p6
over	incl																								
3	6	0	-30	-20	-10	-4	-4	0	0	0	0	0	0	$\pm 2.5$	$\pm 4.0$	+3	+6	+8	+6	+9	+13	+9	+12	+16	+20
		-8	-38	-28	-18	-9	-12	-5	-8	-12	-18	-30	-48			-2	-2	-4	+1	+1	+1	+4	+4	+8	+12
6	10	0	-40	-25	-13	-5	-5	0	0	0	0	0	0	$\pm 3.0$	$\pm 4.5$	+4	+7	+10	+7	+10	+16	+12	+15	+19	+24
		-8	-49	-34	-22	-11	-14	-6	-9	-15	-22	-36	-58			-2	-2	-5	+1	+1	+1	+6	+6	+10	+15
10	18	0	-50	-32	-16	-6	-6	0	0	0	0	0	0	$\pm 4.0$	$\pm 5.5$	+5	+8	+12	+9	+12	+19	+15	+18	+23	+29
		-8	-61	-43	-27	-14	-17	-8	-11	-18	-27	-43	-70			-3	-3	-6	+1	+1	+1	+7	+7	+12	+18
18	30	0	-65	-40	-20	-7	-7	0	0	0	0	0	0	$\pm 4.5$	$\pm 6.5$	+5	+9	+13	+11	+15	+23	+17	+21	+28	+35
		-10	-78	-53	-33	-16	-20	-9	-13	-21	-33	-52	-84			-4	-4	-8	+2	+2	+2	+8	+8	+15	+22
30	50	0	-80	-50	-25	-9	-9	0	0	0	0	0	0	$\pm 5.5$	$\pm 8.0$	+6	+11	+15	+13	+18	+27	+20	+25	+33	+42
		-12	-96	-66	-41	-20	-25	-11	-16	-25	-39	-62	-100			-5	-5	-10	+2	+2	+2	+9	+9	+17	+26
50	80	0	-100	-60	-30	-10	-10	0	0	0	0	0	0	$\pm 6.5$	$\pm 9.5$	+6	+12	+18	+15	+21	+32	+24	+30	+39	+51
		-15	-119	-79	-49	-23	-29	-13	-19	-30	-46	-74	-120			-7	-7	-12	+2	+2	+2	+11	+11	+20	+32
80	120	0	-120	-72	-36	-12	-12	0	0	0	0	0	0	$\pm 7.5$	$\pm 11.0$	+6	+13	+20	+18	+25	+38	+28	+35	+45	+59
		-20	-142	-94	-58	-27	-34	-15	-22	-35	-54	-87	-140			-9	-9	-15	+3	+3	+3	+13	+13	+23	+37
120	180	0	-145	-85	-43	-14	-14	0	0	0	0	0	0	$\pm 9.0$	$\pm 12.5$	+7	+14	+22	+21	+28	+43	+33	+40	+52	+68
		-25	-170	-110	-68	-32	-39	-18	-25	-40	-63	-100	-160			-11	-11	-18	+3	+3	+3	+15	+15	+27	+43
180	250	0	-170	-100	-50	-15	-15	0	0	0	0	0	0	$\pm 10.0$	$\pm 14.5$	+7	+16	+25	+24	+33	+50	+37	+46	+60	+79
		-30	-199	-129	-79	-35	-44	-20	-29	-46	-72	-115	-185			-13	-13	-21	+4	+4	+4	+17	+17	+31	+50
250	315	0	-190	-110	-56	-17	-17	0	0	0	0	0	0	$\pm 11.5$	$\pm 16.0$	+7	+16	+26	+27	+36	+56	+43	+52	+66	+88
		-35	-222	-142	-88	-40	-49	-23	-32	-52	-81	-130	-210			-16			+4	+4	+4	+20	+20	+34	+56
315	400	0	-210	-125	-62	-18	-18	0	0	0	0	0	0	$\pm 12.5$	$\pm 18.0$	+7	+18	+29	+29	+40	+61	+46	+57	+73	+98
		-40	-246	-161	-98	-43	-54	-25	-36	-57	-89	-140	-230			-18		-28	+4	+4	+4	+21	+21	+37	+62
400	500	0	-230	-135	-68	-20	-20	0	0	0	0	0	0	$\pm 13.5$	$\pm 20.0$	+7	+20	+31	+32	+45	+68	+50	+63	+80	+108
		-45	-270	-175	-108	-47	-60	-27	-40	-63	-97	-155	-250			-20		-32	+5	+5	+5	+23	+23	+40	+68
500	630	0	-260	-145	-76	-	-22	-	0	0	0	0	0	-	$\pm 22.0$	-	-	-	-	+44	+70	-	+70	+88	+122
		-50	-304	-189	-120	-	-66	-	-44	-70	-110	-175	-280							0	0	-	+26	+44	+78
630	800	0	-290	-160	-80	-	-24	-	0	0	0	0	0	-	$\pm 25.0$	-	-	-	-	+50	+80	-	+80	+100	+138
		-75	-340	-210	-130	-	-74	-	-50	-80	-125	-200	-320							0	0	-	+30	+50	+88
800	1000	0	-320	-170	-86	-	-26	-	0	0	0	0	0	-	$\pm 28.0$	-	-	-	-	+56	+90	-	+90	+112	+156
		-100	-376	-226	-142	-	-82	-	-56	-90	-140	-230	-360							0	0	-	+34	+56	+100
1000	1250	0	-350	-195	-98	-	-28	-	0	0	0	0	0	-	$\pm 33.0$	-	-	-	-	+66	+105	-	+106	+132	+186
		-125	-416	-261	-164	-	-94	-	-66	-105	-165	-260	-420							0	0	-	+40	+66	+120
1250	1600	0	-390	-220	-110	-	-30	-	0	0	0	0	0	-	$\pm 39.0$	-	-	-	-	+78	+125	-	+126	+156	+218
		-160	-468	-298	-188	-	-108	-	-78	-125	-195	-310	-500							0	0	-	+48	+78	+140
1600	2000	0	-430	-240	-120	-	-32	-	0	0	0	0	0	-	$\pm 46.0$	-	-	-	-	+92	+150	-	+150	+184	+262
		-200	-522	-332	-212	-	-124	-	-92	-150	-230	-370	-600							0	0	-	+58	+92	+170

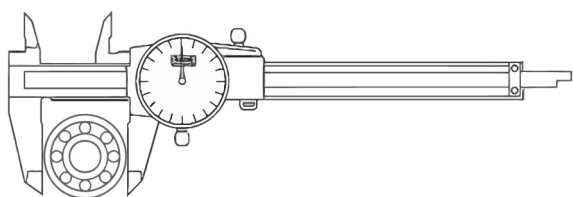

## TOLERANCE TABLES

### Tolerances for Housing Bore Diameters

units :  $\mu\text{m}$

Diameters (mm)		$\Delta_{Dmp}$	E6	F6	F7	G6	G7	H6	H7	H8	J6	J7	JS6	JS7	K5	K6	K7	M5	M6	M7	N5	N6	N7	P6	P7
over	incl																								
10	18	0	+43	+27	+34	+17	+24	+11	+18	+27	+6	+10	$\pm 5.5$	$\pm 9$	+2	+2	+6	-4	-4	0	-9	-9	-5	-15	-11
		-8	+32	+16	+16	+6	+6	0	0	0	-5	-8			-6	-9	-12	-12	-15	-18	-17	-20	-23	-26	-29
18	30	0	+53	+33	+41	+20	+28	+13	+21	+33	+8	+12	$\pm 6.5$	$\pm 10.5$	+1	+2	+6	-5	-4	0	-12	-11	-7	-18	-14
		-9	+40	+20	+20	+7	+7	0	0	0	-5	-9			-8	-11	-15	-14	-17	-21	-21	-24	-28	-31	-35
30	50	0	+66	+41	+50	+25	+34	+16	+25	+39	+10	+14	$\pm 8$	$\pm 12.5$	+2	+3	+7	-5	-4	0	-13	-12	-8	-21	-17
		-11	+50	+25	+25	+9	+9	0	0	0	-6	-11			+9	-13	-18	-16	-20	-25	-24	-28	-33	-37	-42
50	80	0	+79	+49	+60	+29	+40	+19	+30	+46	+13	+18	$\pm 9.5$	$\pm 15$	+3	+4	+9	-6	-5	0	-15	-14	-9	-26	-21
		-13	+60	+30	+30	+10	+10	0	0	0	-6	-12			-10	-15	-21	-19	-24	-30	-28	-33	-39	-45	-51
80	120	0	+94	+58	+71	+34	+47	+22	+35	+54	+16	+22	$\pm 11$	$\pm 17.5$	+2	+4	+10	-8	-6	0	-18	-16	-10	-30	-24
		-15	+72	+36	+36	+12	+12	0	0	0	-6	-13			-13	-18	-25	-23	-28	-35	-33	-38	-45	-52	-59
120	150	0	+110	+68	+83	+39	+54	+25	+40	+63	+18	+26	$\pm 12.5$	$\pm 20$	+3	+4	+12	-9	-8	0	-21	-20	-12	-36	-28
		-18	+85	+43	+43	+14	+14	0	0	0	-7	-14			-15	-21	-28	-27	-33	-40	-39	-45	-52	-61	-68
150	180	0	+110	+68	+83	+39	+54	+25	+40	+63	+18	+26	$\pm 12.5$	$\pm 20$	+3	+4	+12	-9	-8	0	-21	-20	-12	-36	-28
		-25	+85	+43	+43	+14	+14	0	0	0	-7	-14			-15	-21	-28	-27	-33	-40	-39	-45	-52	-61	-68
180	250	0	+129	+79	+96	+44	+61	+29	+46	+72	+22	+30	$\pm 14.5$	$\pm 23$	+2	+5	+13	-11	-8	0	-25	-22	-14	-41	-33
		-30	+100	+50	+50	+15	+15	0	0	0	-7	-16			-18	-24	-33	-31	-37	-46	-45	-51	-60	-70	-79
250	315	0	+142	+88	+108	+49	+69	+32	+52	+81	+25	+36	$\pm 16$	$\pm 26$	+3	+5	+16	-13	-9	0	-27	-25	-14	-47	-36
		-35	+110	+56	+56	+17	+17	0	0	0	-7	-16			-20	-27	-36	-36	-41	-52	-50	-57	-66	-79	-88
315	400	0	+161	+98	+119	+54	+75	+36	+57	+89	+29	+39	$\pm 18$	$\pm 28.5$	+3	+7	+17	-14	-10	0	-30	-26	-16	-51	-41
		-40	+125	+62	+62	+18	+18	0	0	0	-7	-18			-22	-29	-40	-39	-46	-57	-55	-62	-73	-87	-98
400	500	0	+175	+108	+131	+60	+83	+40	+63	+97	+33	+43	$\pm 20$	$\pm 31.5$	+2	+8	+18	-16	-10	0	-33	-27	-17	-55	-45
		-45	+135	+68	+68	+20	+20	0	0	0	-7	-20			-25	-32	-45	-43	-50	-63	-60	-67	-80	-95	-108
500	630	0	+189	+120	+146	+66	+92	+44	+70	+110	-	-	$\pm 22$	$\pm 35$	-	0	0	-	-26	-26	-	-44	-44	-78	-78
		-50	+145	+76	+76	+22	+22	0	0	0	-	-			-	-44	-70	-	-70	-96	-	-88	-114	-122	-148
630	800	0	+210	+130	+160	+74	+104	+50	+80	+125	-	-	$\pm 25$	$\pm 40$	-	0	0	-	-30	-30	-	-50	-50	-88	-88
		-75	+160	+80	+80	+24	+24	0	0	0	-	-			-	-50	-80	-	-80	-110	-	-100	-130	-138	-168
800	1000	0	+226	+142	+176	+82	+116	+56	+90	+140	-	-	$\pm 28$	$\pm 45$	-	0	0	-	-34	-34	-	-56	-56	-100	-100
		-100	+170	+86	+86	+26	+26	0	0	0	-	-			-	-56	-90	-	-90	-124	-	-112	-146	-156	-190
1000	1250	0	+261	+164	+203	+94	+133	+66	+105	+165	-	-	$\pm 33$	$\pm 52.5$	-	0	0	-	-40	-40	-	-66	-66	-120	-120
		-125	+195	+98	+98	+28	+28	0	0	0	-	-			-	-66	-105	-	-106	-145	-	-132	-171	-186	-225
1250	1600	0	+298	+188	+235	+108	+155	+78	+125	+195	-	-	$\pm 39$	$\pm 62.5$	-	0	0	-	-48	-48	-	-78	-78	-140	-140
		-160	+220	+110	+110	+30	+30	0	0	0	-	-			-	-78	-125	-	-126	-173	-	-156	-203	-218	-265
1600	2000	0	+332	+212	+270	+124	+182	+92	+150	+230	-	-	$\pm 46$	$\pm 75$	-	0	0	-	-58	-58	-	-92	-92	-170	-170
		-200	+240	+120	+120	+32	+32	0	0	0	-	-			-	-92	-150	-	-150	-208	-	-184	-242	-262	-320
2000	2500	0	+370	+240	+305	+144	+209	+110	+175	+280	-	-	$\pm 55$	$\pm 87.5$	-	0	0	-	-68	-68	-	-110	-110	-195	-195
		-250	+260	+130	+130	+34	+34	0	0	0	-	-			-	-110	-175	-	-178	-243	-	-220	-285	-305	-370









COMPONENTS FOR TECHNICS



PRODUCT CATALOGUE

CT International s.r.o.  
Na pasekách 17, 83106 Bratislava, Slovakia  
tel.: + 421 917 793 827 fax: + 421 267 272 157  
info@ct-international.sk  
www.ct-international.sk